

AETECHRON



8700 Series

Operator's Manual

*Ultra-Wide-Bandwidth, High-Power Switch-Mode Amplifiers
Models 8708, 8712, 8716, 8720, and 8724*

574.295.9495 | www.aetechron.com
2507 Warren Street, Elkhart, IN 46516

DECLARATION OF CONFORMITY

Issued By: AE Techron, Inc.
2507 Warren Street
Elkhart, IN 46516

For Compliance Questions Only: Larry Shank
+1 574-295-9495
lshank@aetechron.com

This Declaration of Conformity is issued under the sole responsibility of AE Techron, Inc., and belongs to the following product:

Equipment Type: Industrial Power Amplifiers

Model Name: 8704

EMC Standards:

- EN 61326-1: 2013 – Electrical Equipment for Measurement, Control and Laboratory Use – Industrial Level & Performance, Group 1, Class A, Criteria A
- CISPR 16-2-3 – Specification for radio disturbance and immunity measuring apparatus and methods – Part 2-3: Methods of measurement of disturbances and immunity – Radiated disturbance measurement
- CISPR 16-2-1 – Specification for radio disturbance and immunity measuring apparatus and methods – Part 2-1: Methods of measurement of disturbances and immunity – Conducted disturbance measurement
- EN 61000-4-11 – Electromagnetic compatibility (EMC) Part 4: Testing and measurement techniques – voltage dips, short interruptions and voltage variations immunity tests for equipment with input current up to 16A per phase
- EN 61000-4-8 – Electromagnetic compatibility (EMC) Part 4: Testing and measurement techniques – voltage dips, short interruptions and voltage variations immunity tests for equipment with input current up to 16A per phase
- EN 61000-4-6 – Electromagnetic compatibility (EMC) Part 4: Testing and measurement techniques – voltage dips, short interruptions and voltage variations immunity tests for equipment with input current up to 16A per phase
- EN 61000-4-5 – Electromagnetic compatibility (EMC) Part 4: Testing and measurement techniques – voltage dips, short interruptions and voltage variations immunity tests for equipment with input current up to 16A per phase
- EN 61000-4-4 – Electromagnetic compatibility (EMC) Part 4: Testing and measurement techniques – voltage dips, short interruptions and voltage variations immunity tests for equipment with input current up to 16A per phase
- EN 61000-4-3 – Electromagnetic compatibility (EMC) Part 4: Testing and measurement techniques – voltage dips, short interruptions and voltage variations immunity tests for equipment with input current up to 16A per phase
- EN 61000-4-2 – Electromagnetic compatibility (EMC) Part 4: Testing and measurement techniques – voltage dips, short interruptions and voltage variations immunity tests for equipment with input current up to 16A per phase

Safety Standard:

- EN 61010-1:2010/A1:2019 – Safety requirements for electrical equipment for measurement, control, and laboratory use

I certify that the product identified above conforms to the requirements of the EMC Council Directive 2014/30/EU, and the Low Voltage Directive 2014/35/EU.

Signed:



Larry J. Shank
President

Place of Issue: Elkhart, IN, USA
Date of Issue: 05-06-2022

CE Affixing Date: 05-04-2022

Three-Year, No-Fault Warranty

SUMMARY OF WARRANTY

AE TECHRON INC., of Elkhart, Indiana (Warrantor) warrants to you, the ORIGINAL COMMERCIAL PURCHASER and ANY SUBSEQUENT OWNER of each NEW **AE TECHRON INC. product, for a period of three (3) years from the date of purchase, by the original purchaser (warranty period) that the product is free of defects in materials and workmanship and will meet or exceed all advertised specifications for such a product. We further warrant the new AE Techron product regardless of the reason for failure, except as excluded in the Warranty.**

ITEMS EXCLUDED FROM WARRANTY

This AE Techron Warranty is in effect only for failure of a new AE Techron product which occurred within the Warranty Period. It does not cover any product which has been damaged because of any intentional misuse, or loss which is covered under any of your insurance contracts. This warranty does not extend to any product on which the serial number has been defaced, altered, or removed. It does not cover damage to loads or any other products or accessories resulting from **AE TECHRON INC.** product failure. It does not cover defects or damage caused by the use of unauthorized modifications, accessories, parts, or service.

WHAT WE WILL DO

We will remedy any defect, regardless of the reason for failure (except as excluded), by repair or replacement, at our sole discretion. Warranty work can only be performed at our authorized service centers or at our factory.

Expenses in remedying the defect will be borne by **AE TECHRON INC.**, including one-way surface freight shipping costs within the United States. (Purchaser must bear the expense of shipping the product between any foreign country and the port of entry in the United States and all taxes, duties, and other customs fees for such foreign shipments.)

HOW TO OBTAIN WARRANTY SERVICE

When you notify us or one of our authorized service centers of your need for warranty service, you will receive an authorization to return the product for service. All components must be shipped in a factory pack or equivalent which, if needed, may be obtained

from us for a nominal charge. We will take corrective actions and return the product to you within three weeks of the date of receipt of the defective product, or will make available to you a product of equal or better performance on temporary loan until your product can be repaired or replaced and returned to you. If the repairs made by us are not satisfactory, notify us immediately.

DISCLAIMER OF CONSEQUENTIAL AND INCIDENTAL DAMAGES

You are not entitled to recover from us any consequential or incidental damages resulting from any defect in our product. This includes any damage to another product or products resulting from such a defect.

WARRANTY ALTERATIONS

No person has the authority to enlarge, amend, or modify this warranty. The warranty is not extended by the length of time for which you are deprived of the use of this product. Repairs and replacement parts provided under the terms of this warranty shall carry only the unexpired portion of this warranty.

DESIGN CHANGES

We reserve the right to change the design of any product from time to time without notice and with no obligation to make corresponding changes in products previously manufactured.

LEGAL REMEDIES OF PURCHASER

There is no warranty that extends beyond the terms hereof. This written warranty is given in lieu of any oral or implied warranties not contained herein. We disclaim all implied warranties, including, without limitation, any warranties of merchantability or fitness for a particular purpose. No action to enforce this Warranty shall be commenced later than ninety (90) days after expiration of the warranty period. This statement of warranty supersedes any others contained in this manual for AE Techron products.

AE TECHRON INC.

Customer Service Department

2507 Warren St. Elkhart, IN, 46516, U.S.A.
(574) 295-9495
www.aetechron.com

Contents

1	Introduction	5
1.1	Configuration Options.....	5
2	Amplifier Unpacking and Installation	6
2.1	Safety First	6
2.2	Unpacking	6
2.3	Check Contents.....	7
2.4	8700 Series Placement	7
3	Connections and Startup	8
3.1	Testing Before Controlled-Current Operation	8
3.2	Connecting the Load	8
3.3	Other DIP Switch Settings.....	9
3.4	Monitor and Sense Ports.....	9
3.5	Connecting the AC Supply	10
3.6	Start-up Procedure.....	11
4	Amplifier Operation	12
4.1	Front-Panel Controls and Indicators.....	12
4.2	Back-Panel Controls & Connectors.....	14
4.3	Back-Panel Safety Features.....	14
5	Advanced Configuration.....	15
5.1	DIP Switch Configurations.....	15
6	Applications.....	19
6.1	Controlled-Current Operation.....	19
6.2	Driving Reactive Loads	22
7	Maintenance	23
7.1	Clean Amplifier Filter and Grills.....	23
8	Troubleshooting	24
8.1	Introduction & Precautions	24
8.2	Visual Inspection	24
8.3	No Signal.....	24
8.4	No LEDs Illuminated.....	24
8.5	Over/Under Line LED Lit	24
8.6	Run/Standby LED Remains Amber	25
8.7	Amplifier Overheats (Over Temp Fault Condition).....	25
8.8	Fault LED is Illuminated	25
8.9	Factory Service	26
	Appendix A: Gain DIP Switch Settings	27
	Appendix B: Amplifier Module Wiring Diagrams.....	33



Figure 1.1 – 8700 Series Front Panel

1 Introduction

Congratulations on your purchase of an 8700 series power amplifier. 8700 series amplifiers are 400Vp, low-noise, DC-to-250-kHz switch-mode amplifiers. The 8700 series provides a unique combination of switch-mode and linear amplifiers. Switch-mode efficiency is combined with a low noise floor and THD, while also benefitting from high slew rates and wide bandwidth. The 8700 series is also able to safely drive both reactive and resistive loads of varying impedances with no loss in rated output power.

8700 series amplifiers pack a lot of power into a small package. They are able to produce surge power ratings at up to 2.5X continuous and process apparent power at levels up to 5X the continuous power ratings. This makes an 8700 series amplifier an ideal choice for many difficult-to-drive reactive loads.

This combination of features makes the 8700 series an ideal solution for a wide range of high-current, low-voltage applications that require both DC power and quick surges or drop-outs, like those found in conducted immunity testing of DC-powered systems in the automotive and aviation markets.

1.1 Configuration Options

A key to everyday product usability is quick and easy product (re)configuration. The 8700 series amplifier provides all key configuration controls on the back panel of the unit. Configuration options available include:

- **Gain:** Fixed or variable gain (0 to 40)
- **Current Limit:** From 5% to rated limit (to protect fragile DUTs or where specified in the Standard)
- **DC Control:** DC enabled or DC blocked and DC Servo (for driving transformer-coupled loads, coils)
- **Input:** Balanced and/or unbalanced
- **Mode:** Voltage source or current source
- **Output Impedance:** Variable from 0 to 1 ohm (Voltage mode)
- **Sense:** Sense line with correction of up to 4 volts

Performance Overview	
Bandwidth	DC - 250 kHz
Slew rate	Up to 300V/μs
Voltage	0 to 250 VRMS; 0 to 350 VDC
Current	Up to 60 to 360 ARMS*
Distortion	<0.8%
Power	4 kW to 24 kW*
Apparent Power	Up to 120 kVA

*Models available with output power from 4 kW to 24 kW (capable of up to 120 kVA).

2 Amplifier Unpacking and Installation

8700 series amplifiers are precision instruments that can be dangerous if not handled properly. Lethal voltages are present in both the AC input supply and the output of the amplifier. For this reason, safety should be your primary concern when you setup and operate this amplifier.

2.1 Safety First

Throughout this manual special emphasis is placed on good safety practices. The following graphics are used to highlight certain topics that require extra precaution.

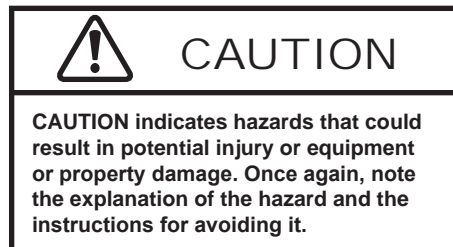
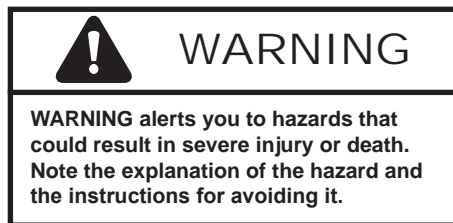
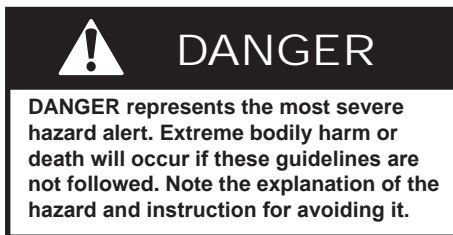

2.2 Unpacking

Your amplifier will be delivered to the ship-to address enclosed in a wooden crate and transported on a special, shock-absorbing pallet. With the addition of packaging, the amplifier can weigh up to 700 pounds (318 kg). To avoid serious injury and/or product damage, use a heavy-duty lift or other suitable equipment to unpack and move the product to its place of installation.



To uncrate the product, remove the crate's top, front, and back. Remove the accessories located on the crate's shelf, then remove the shelf and packing material. Use a forklift or other suitable equipment to glide the amplifier from the crate and off the pallet. Forklift provisions are provided in the base of the cabinet to facilitate this removal procedure (see **Figure 2.1**).

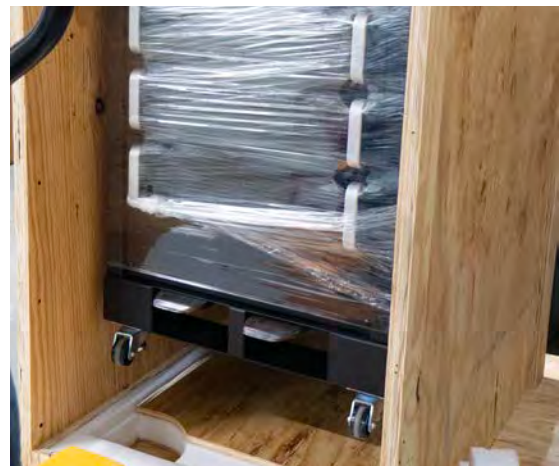
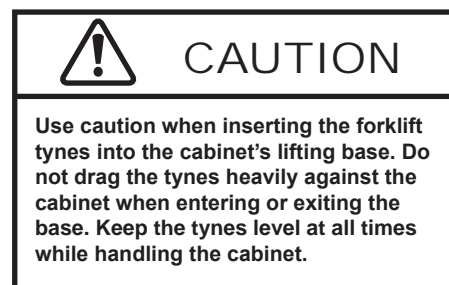

Figure 2.1 – Provisions in Cabinet Base for Forklifts



The amplifier has been tested and inspected for damage before leaving the factory. Carefully unpack and inspect the product for damage. **Please note any damage for future reference and notify the shipping company immediately if damage is found.** Also, please save the shipping crate and pallet as evidence of damage and/or for returning the amplifier for repair.

2.3 Check Contents

In addition to the 8700 series amplifier, your shipment should include the following:

1. Quick Start Guide
2. 8700 series Operation Manual on USB drive

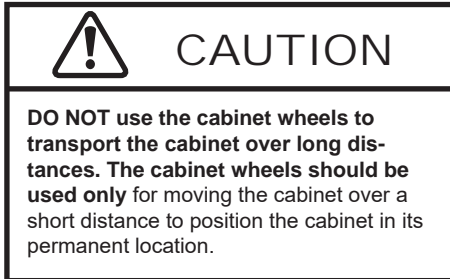

2.4 8700 Series Placement

8700 series amplifiers are mounted on wheels to allow rolling on a flat, smooth surface. The cabinet wheels should be used only for moving the cabinet over a short distance to position the cabinet in its permanent location. DO NOT use the cabinet wheels to move the cabinet over long distances. To avoid possible tipping, always push the amplifier from the front and avoid rough or pitted surfaces.

Locate your amplifier near a three-phase power source. Allow enough clearance at the front and back of the amplifier to allow adequate airflow and hot air discharge through the amplifier rear. See **Figure 2.2** for clearance recommendations.

All of the wheels on the cabinet are equipped with a leveling pad that can be used to adjust the height of each wheel (see **Figure 2.3**). This leveling mechanism will also act to lock each wheel in place and prevent unintentional movement of the cabinet.

Two covers have been provided to insert into fork lifting openings at the front of the cabinet once the cabinet has been set in its final location.

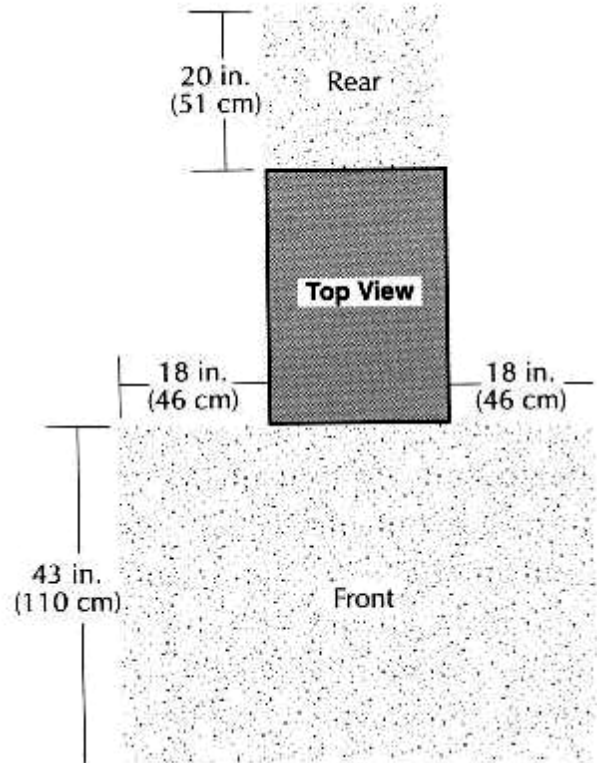

Figure 2.2 – Clearance Recommendations for Amplifier Placement



Figure 2.3 – Leveling pads on Cabinet Wheels



Figure 3.1 – 8700 series I/O Panel (back panel)

3 Connections and Startup

This section details the wiring and startup procedures for an 8700 series amplifier operating in Controlled-Voltage mode (factory default). Before connecting the amplifier inputs and outputs, make sure the AC power is disconnected.

3.1 Testing Before Controlled-Current Operation

IMPORTANT: If your application requires Controlled Current operation, the 8700 series amplifier first should be wired and tested in Controlled-Voltage mode to verify that the amplifier and input signal are operating correctly. Once proper operation is confirmed, refer to the **Applications** section of this manual for instructions on configuring and operating your amplifier in Controlled-Current mode.

	WARNING
<p>ELECTRIC SHOCK HAZARD.</p> <p>Output potentials can be lethal. Make connections only with AC Power OFF and input signals removed.</p>	

3.2 Connecting the Load

3.2.1 Preparation and Cautions

Before connecting the amplifier, make sure the AC power is disconnected.

Always use the appropriate wire size and insulation for the maximum current and voltage expected at the output. Never connect the output of the amplifier to any other model amplifier, power supply, signal source, or other inappropriate load; fire can result.

	WARNING
<p>ELECTRIC SHOCK HAZARD.</p> <p>Follow these safety precautions before opening the amplifier's back access door:</p> <ul style="list-style-type: none"> • Disconnect the AC power supply. • Wait at least 3-5 minutes after disconnecting AC power before opening the access door. • Wear safety goggles. • Contact AE Techron Technical Support for any questions or concerns. 	

	WARNING
<p>POTENTIAL SHOCK AND FIRE HAZARD.</p> <p>Torque 3/8" nuts on output terminals to 10 ft.-lbs. with or without cables connected.</p>	

3.2.2 Output Connections

Connection to the output of the amplifier is to a pair of high-current output terminals located on the amplifier back I/O panel. Wires terminated with 3/8-inch ring terminals are recommended when connecting to the output terminals. Connect the

load across the terminals marked “OUTPUT” (positive) and “GND” (ground). The GND terminal also can be connected to an external ground point such as the amplifier chassis, if desired. See **Figure 3.2**.

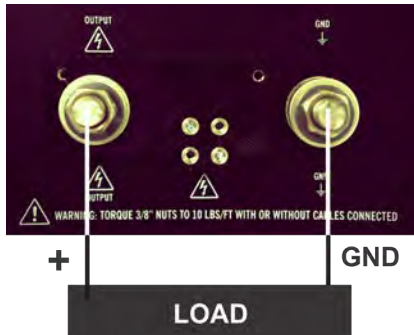

Figure 3.2 – Connecting the Load

Be sure to install the output safety cover after wiring the output connections. See **Figure 3.3**.



Figure 3.3 – Output Safety Cover

Connecting the Input Signal

Both an unbalanced Input BNC jack and a balanced Input “WECO” terminal block connector (mating WECO connector provided) are available on the amplifier back I/O panel for signal input. Connect your input signal source to the unbalanced or balanced input connector as shown in **Figure 3.4**. Use cables that are high quality and

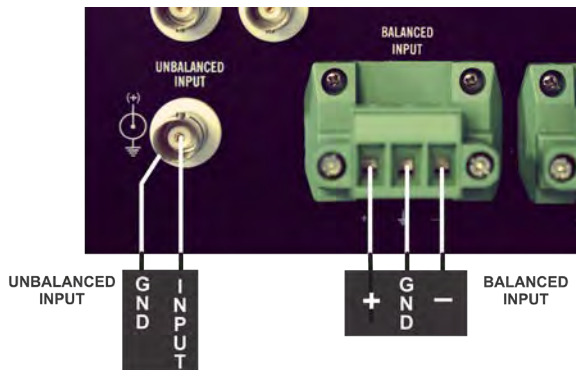

Figure 3.4 – Wiring for Unbalanced or Balanced Input Connector

shielded to minimize noise and to guard against possible feedback.

DIP switch #1, located on the back panel of the Master amplifier module (uppermost module in the amplifier) can be used to enable/disable the unbalanced input connector, and DIP switch #2 can be used to enable/disable the balanced input connector.

When these two DIP switches are placed in the UP position (factory default), the input connectors are enabled. When the DIP switches are placed in the DOWN position, the input connectors are disabled. See **Figure 3.5** for DIP switch locations.

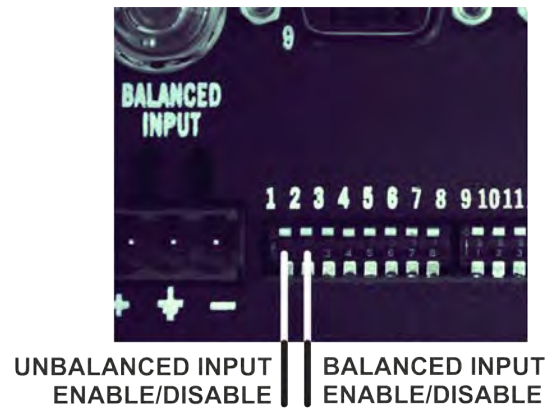

Figure 3.5 – DIP Switch Locations for Input Connector Enable/Disable

3.3 Other DIP Switch Settings

Other DIP switches located on the amplifier module labeled “Master” can be used to enable features or configure the amplifier for special applications. See the **Advanced Configuration** section of this manual for more information. Before operating the amplifier, check to make sure all DIP switches are set as intended. See **Figure 5.1** for the factory default setting for all DIP switches.

3.4 Monitor and Sense Ports

The amplifier provides three additional ports on the back I/O panel:

- Current Monitor (BNC connector)
- Voltage Monitor (BNC connector)
- Remote Sense Port (2-pin terminal block connector).

See the **Applications** section of this manual for information on using these ports

WARNING

ELECTRIC SHOCK HAZARD. Power supply wiring should only be performed by a qualified, licensed electrician.

DANGER

The risk of lethal **ELECTRICAL SHOCK** exists when connecting AC mains! Disconnect the source before connecting AC power wires to the amplifier's AC inputs.

3.5 Connecting the AC Supply

3.5.1 Disconnect and Inlet Wiring Protection

A safety disconnect device for the AC mains input must be installed so that it is both nearby and accessible to the operator. The disconnect must be clearly labeled.

Inlet wiring must support the rated current.

The amplifier must be protected by fuses or circuit breakers that protect the power inlet wiring with a

maximum rating no more than the rated current for the product model.

Full AC requirements by product model are detailed below:

MODEL	208V (±10%)	400V (±10%)
8708	30A, 50/60 Hz	30A, 50/60 Hz
8712	30A, 50/60 Hz	30A, 50/60 Hz
8716	60A, 50/60 Hz	60A, 50/60 Hz
8720	60A, 50/60 Hz	60A, 50/60 Hz

3.5.2 AC Inlet Connections

Always operate the amplifier from the proper AC mains. The 8700 series amplifier requires three-

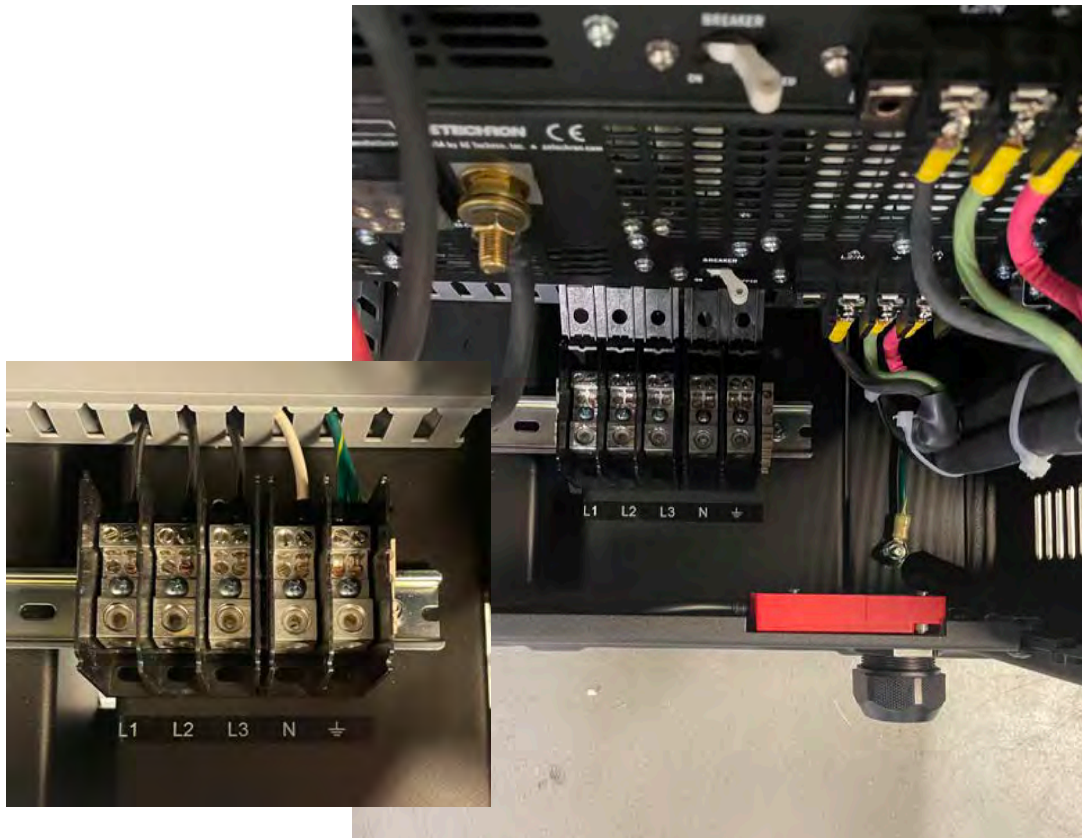

Figure 3.6 – Location of AC Mains Barrier Strip with labeling detail (inset)

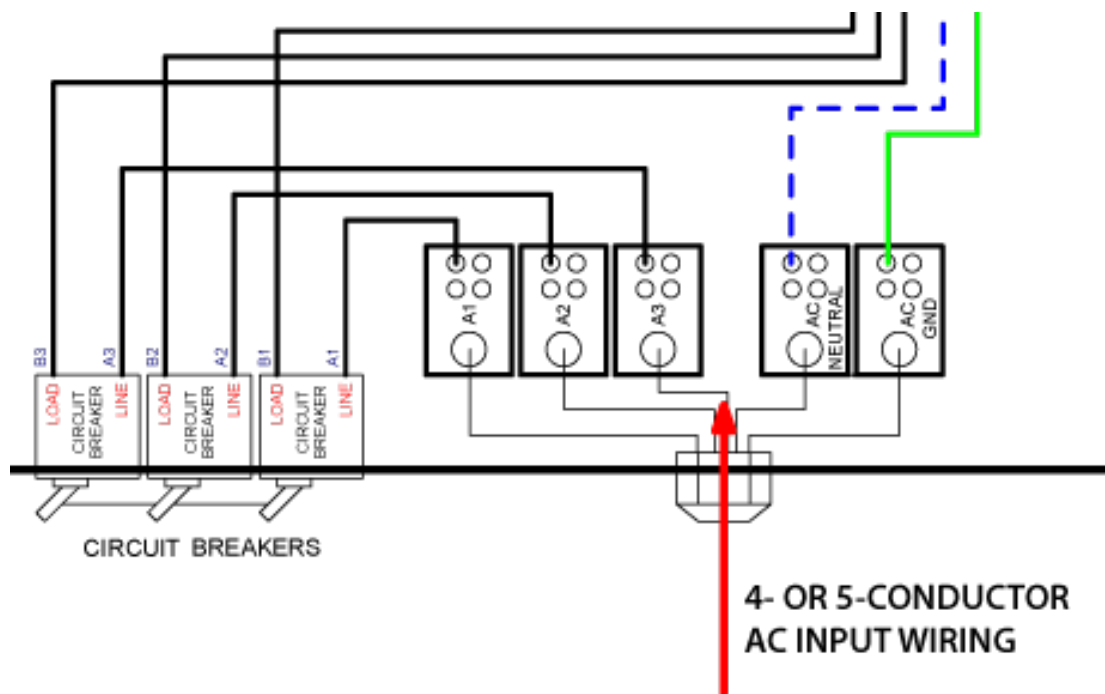

Figure 3.7 – Three-Phase AC Mains Wiring

phase, 50-60 Hz, 208 VAC (or optional 400 VAC) with no more than 10% variance above or below the line voltage. The amplifier will not operate properly outside these limits.

Connect protective grounding terminal to AC mains ground before turning on power to prevent electric shock hazard.

Do not disconnect or disable the protective grounding connection. Doing so causes a potential electrical shock hazard.

Complete the following steps to connect the amplifier to your three-phase power source:

1. Wear safety goggles.
2. Disconnect your AC power source.
3. Open the access door on the back of the amplifier and locate the fuse and AC inlet panel near the bottom of the amplifier. Locate the power block, which is mounted behind the fuse and AC inlet panel (see **Figure 3.5**).
4. Route the 10 AWG, 5 conductor power input cable into the amplifier through the cable strain relief (located on the fuse and AC inlet panel).
5. Connect to the AC mains barrier strip as shown in **Figure 3.7**. See **Appendix B** for wiring diagrams of the complete AC power systems.
6. If connecting to an AC power cord, verify connector wiring for phases, neutral and safety ground. Verify that proper phase, neutral and safety ground connections have been made at the AC mains breaker.

IMPORTANT

Operation of the amplifier at frequencies above 100 kHz without an output load is NOT RECOMMENDED.

The low-pass filter in your amplifier was designed to function with a load attached to the amplifier output. If the amplifier is operated without a load at frequencies above 100 kHz, higher than expected gains may result.

An output load of 2-8 ohms is recommended for operation above 100 kHz.

3.6 Start-up Procedure

1. Turn down the level of your signal source.
2. Make sure the Emergency Stop button on the front panel is in the ON position (not depressed).
3. Make sure the back panel access door is closed and the breaker switch (near the bottom of the amplifier rear) is in the ON position.
4. Press the front-panel POWER switch to turn the amplifier ON.
5. Wait until the Run/Standby indicator turns solid green.
6. Adjust your input signal level to achieve the desired output level.

4 Amplifier Operation

4.1 Front-Panel Controls and Indicators

This section provides an overview of Front-Panel controls and indicators found on the 8700 series amplifier. Refer to **Figure 4.1** for component locations.

4.1.1 Standby-Run Switch

The Standby-Run switch controls the power to the amplifier's high-voltage transformers. **Switch to the Run position (right) to energize the amplifier. Switch to the Standby position (left) to remove power from the high-voltage transformers and place the amplifier in Standby mode.**

4.1.2 Run/Standby Indicator

Run mode: The indicator will be lit solid green. The amplifier's high-voltage transformers are energized and the unit will amplify the input signal.

Standby mode: The indicator will be lit solid amber. The amplifier will be placed in Standby when one of the following conditions occurs:

1. High/Low Line error
2. Overtemp condition
3. Fault condition
4. The user presses the front-panel power switch to the Standby (left) position.

In Standby mode, the amplifier's low-voltage transformer is energized but the high-voltage transformers are not.

To release the amplifier from Standby mode:

1. **High/Low Line error:** Clear the over- or under-voltage condition. The amplifier will resume operation when the input voltage is brought within the operating range of the amplifier. More information is available in the **High/Low Line Indicator** topic in this section.
2. **Overtemp condition:** Remove the input signal from the amplifier and leave the amplifier with the Standby-Run switch in the Run position and with the fans operating to cool the amplifier. When the amplifier's internal temperature

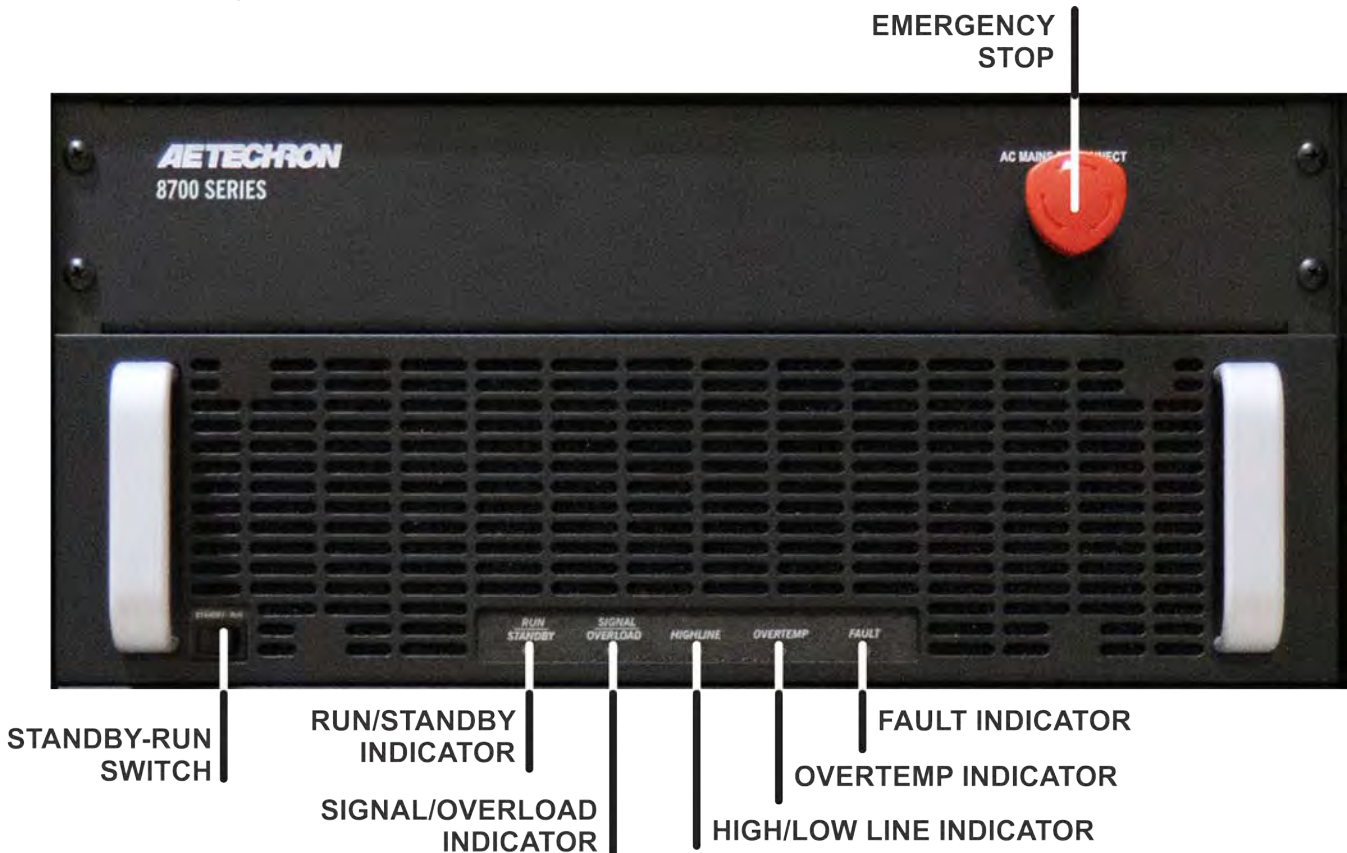

Figure 4.1 – Front Panel Controls and Indicators

drops to less than 100°C, the amplifier will resume operation. Note that in cases where the amplifier's transformers have overheated, up to 15 minutes of cooling time may be required before the amplifier can resume operation. See the **Overtemp Indicator** topic in this section for more information.

3. **Fault condition:** Standby-Run switch to Standby and then back to Run to reset the amplifier. If the fault condition recurs or does not clear, the amplifier may require servicing. See the **Troubleshooting** section for more information.
4. **Power switch pressed:** When the amplifier is operating (Run mode), setting the front-panel Standby-Run switch to the Standby position (left) will place the amplifier in Standby mode. Set the switch to Run (right) to release the amplifier from Standby and return the amplifier to Run mode.

4.1.3 Signal/Overload Indicator

Signal Presence: When an input signal is presented at an active signal input on the amplifier at a level greater than 0.5V, the Signal/Overload indicator will light solid green.

Overload (clipping): The indicator will flash amber intermittently. When the indicator flashes amber, this indicates that the output of the system could not follow the input signal due to voltage or current limits. The amber Overload indicator will begin flashing when distortion is greater than 0.1%.

4.1.4 High/Low Line Indicator

This amber indicator will illuminate and the amplifier will be placed in Standby if the detected AC mains voltage is outside of the operable range of the amplifier ($\pm 10\%$). This can occur when the amplifier's rear panel breaker is off or tripped. It can also occur when the AC supply voltage to the amplifier is too high or too low.

To remove the amplifier from Standby, the AC mains voltage must be brought to within the optimal range. Check the amplifier back panel breaker and reset or turn the breaker on, if needed. If the error does not clear, check the voltage from the AC

mains. Once the fault condition has been cleared, the amplifier will return automatically to Run mode. If the High/Low Line indicator does not turn off or if the amplifier does not return from Standby, the amplifier may require servicing. See the **Troubleshooting** section for more information.

4.1.5 Overtemp Indicator

The amplifier monitors the temperature inside the high-voltage transformers and in the output stage heat sinks. The amber Overtemp indicator will light and the amplifier will be placed in Standby mode when the temperature sensors detect a condition that would damage the amplifier. If the Overtemp pulse is extremely short, as in the case of defective wiring or switches, this indicator may be lit too briefly to observe.

To remove the amplifier from Standby and return it to normal operation after an Overtemp fault has occurred, make sure the amplifier fans are running and then remove the input signal from the amplifier. Allow the fans to run until the amplifier automatically returns to Run mode. See the **Troubleshooting** section for information on identifying and correcting the cause of an Overtemp fault condition.

4.1.6 Fault Indicator

The red Fault indicator will light and the amplifier will be placed in Standby under two conditions:

1. High frequency oscillation is causing high shoot-through current.
2. An output transistor has shorted, causing the output fault condition.

Cycle the front-panel Standby-Run switch (Standby, then Run) to reset the amplifier. If the fault condition recurs or does not clear, the amplifier may require servicing. See the **Troubleshooting** section for more information.

4.1.7 Emergency Stop Button

The Emergency Stop button controls the power to the amplifier. Place in the ON position (not depressed) to energize the amplifier. Switch to the OFF position (depressed) to remove power from the unit.

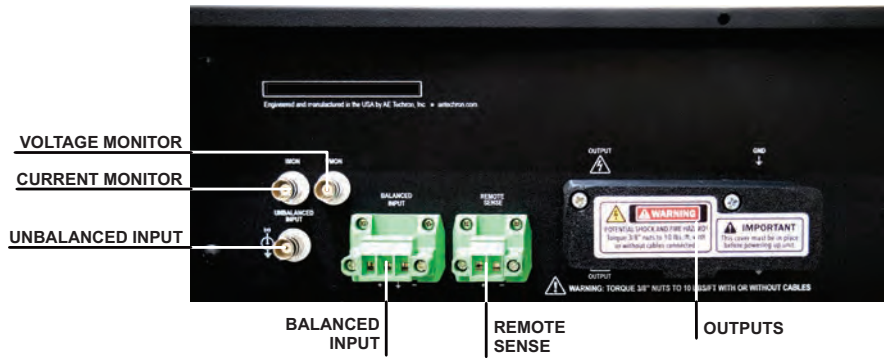

Figure 4.2 – Back Panel Controls and Connectors

4.2 Back-Panel Controls & Connectors

This section provides an overview of Back-Panel controls and connectors found on the 8700 series amplifier. Please refer to **Figure 4.2** for component locations.

Unbalanced BNC Input Connector – This input option provides a standard unbalanced input.

Balanced WECO Input Connector – This input option provides a balanced input. Mating WECO connector is provided with the amplifier.

Current Monitor Connector – This unbalanced BNC port allows for connection to current monitoring equipment. The current monitor output is 1V = 20A.

Voltage Monitor Connector – This unbalanced BNC port allows for connection to voltage monitoring equipment. The voltage monitor output is 1V = 40V.

Remote Sense Port – This 2-pin terminal block connector provides a sense line with up to 4V of correction. The Remote Sense port can be useful when the voltage at the load must be precise. If the cables connecting the amplifier and the load are very long or under-sized, the voltage drop between the amplifier and load can be corrected up to 4V.

The benefits of this feature is limited to frequencies below 10kHz.

Output Terminals – Connect output lines from the load to this pair of high-current output terminals using 3/8-inch ring terminals.

4.3 Back-Panel Safety Features

This section provides an overview of Back-Panel safety features found on the 8700 series amplifier. Please refer to **Figure 4.3** for component locations.

AC Breakers – This switch controls the power to the amplifier. Place in the ON position to energize the amplifier system. Switch to the OFF position to remove power from the system.

Magnetic Safety Switch – This door-mounted switch controls the power to the amplifier. When the amplifier’s back access door is opened, power is removed from the amplifier system. Close the back access door to energize the amplifier system.

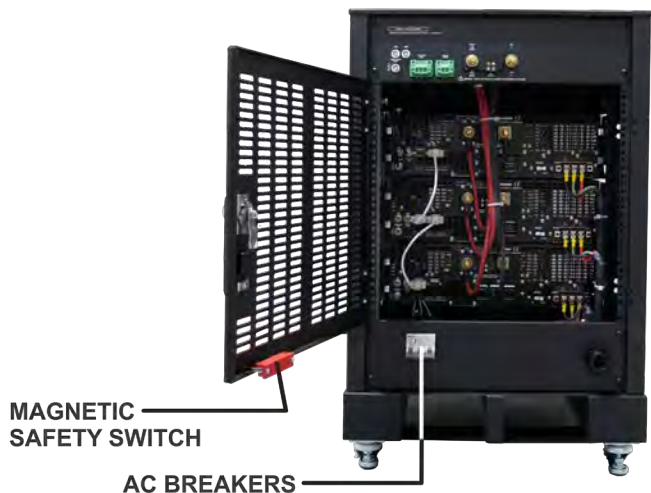

Figure 4.3 – Back Panel Safety Features

5 Advanced Configuration

8700 series amplifiers were designed to offer exceptional versatility in operation. You can choose from a range of field-configurable options, including:

- Enable the unbalanced or balanced signal input connections, or use both inputs.
- Select DC-coupled or AC-coupled operation.
- Enable DC Servo to ensure DC offset remains at zero and safely drive coils and transformers.
- Select Controlled-Current or Controlled-Voltage modes of operation.
- Select an alternate compensation network for Controlled Current operation designed for loads from 1 mH to 5 mH.
- Install a custom compensation network for Controlled Current operation.

- Limit current output via programmable current limits.
- Adjust the amplifier gain from 0.16 to 40 in increments of 0.16.
- Select and enable a synthetic impedance from 0.125 ohms to 0.875 ohms.

5.1 DIP Switch Configurations

The 8700 series amplifier provides 24 DIP switches located on the back panel of the Master amplifier module. Most configuration settings can be made using these DIP switches. See **Figure 5.1** for DIP switch settings and descriptions.

To locate the Master amplifier module, disconnect the amplifier from the AC source, and then open

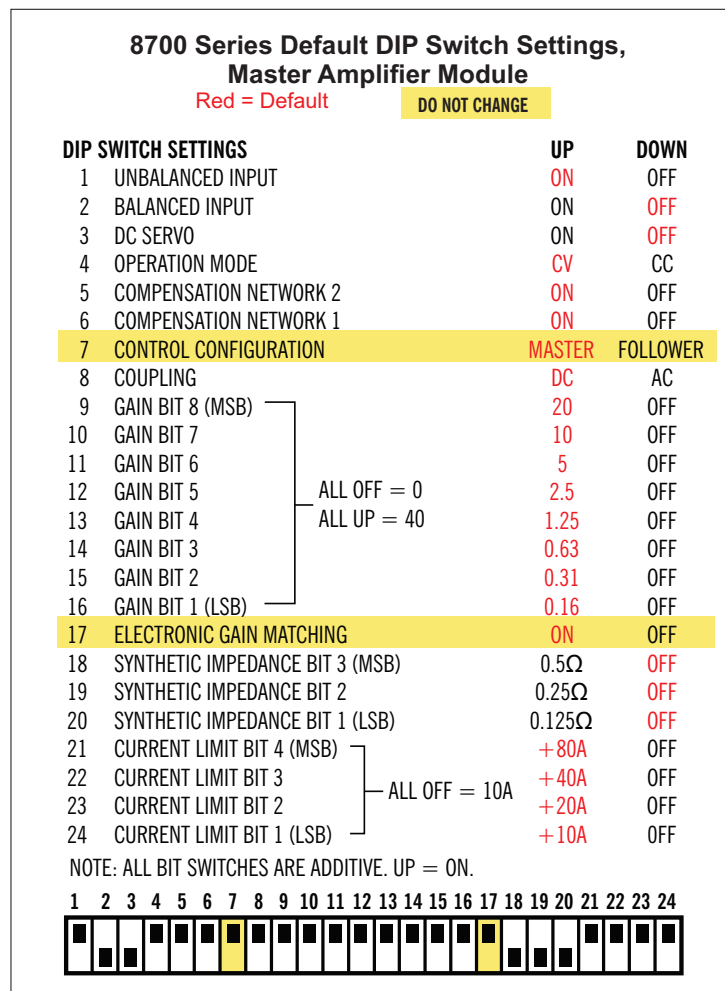



Figure 5.1 – DIP Switch Settings and Descriptions



WARNING

ELECTRIC SHOCK HAZARD.

Follow these safety precautions before opening the amplifier's back access door:

- Disconnect the AC power supply.
- Wait at least 3-5 minutes after disconnecting AC power before opening the access door.
- Wear safety goggles.
- Contact AE Techron Technical Support for any questions or concerns.

the amplifier back access door. The Master amplifier module will be identified by a label reading "Master" located above the DIP switches on the back panel of the module. You can also confirm which module is functioning as the Master module by checking the setting of DIP SW#7. This switch will be in the UP position on the Master module. All other modules will have SW#7 in the DOWN positions. See **Figure 5.2** for module and dip switch locations.



**CONFIGURATION
DIP SWITCHES**

Figure 5.2 – DIP Switches Location on Master Amplifier Module

The DIP switches on the Master amplifier module control the following functions:

SW#1: Unbalanced Input

When this switch is in the UP position (default), the unbalanced BNC input connector is enabled and can be used to send an input signal to the amplifier. When this switch is in the DOWN position, this connector is disabled. Note that disabling an

unused input connector can help to minimize noise going into the amplifier.

SW#2: Balanced Input

When this switch is in the UP position, the balanced WECO input connector is enabled and can be used to send an input signal to the amplifier. When this switch is in the DOWN position (default), this connector is disabled. Note that disabling an unused input connector can help to minimize noise going into the amplifier.

SW#3: DC Servo

The DC Servo function ensures that no DC offset is present at the signal output (-3 dB at 3 Hz). Select DC Servo when driving transformers or other coils. When the DC Servo DIP switch is in the UP position, the DC Servo function is enabled. When this switch is in the DOWN position (default), the DC Servo function is disabled.



CAUTION

Do not change the setting of the Operation Mode switch while the amplifier is operating (Run mode). Damage to the amplifier or the load can occur. Turn off the amplifier and disconnect it from the AC power supply before changing the Operation Mode setting.

SW#4: Operation Mode

When the Operation Mode DIP switch is in the UP position (default), the amplifier will operate in Controlled-Voltage mode, and the amplifier's output voltage will be controlled by its input voltage signal. When this switch is in the DOWN position, the amplifier will operate in Controlled-Current mode, and the amplifier's output current will be controlled by its input voltage signal.

IMPORTANT: Controlled-Current operation requires the use of a compensation network. The 8700 series provides two installed compensation networks: one suitable for loads from 75 μ H to 500 μ H; the other suitable for loads from 500 μ H to 2 mH. If neither of these is suitable for your application, you can choose to install a custom compensation network. For information on install-

ing a custom compensation network, see Section 5.2 “**Internal Configuration.**” For more information on Controlled-Current operation, including instructions for selecting the best RC components for your network, see the topic “Controlled Current Operation” in the **Applications** section of this manual.

SW#5: Compensation Network 2

When the 8700 series amplifier is used in Controlled-Current mode, the current control loop is tuned with an RC network. The factory default network (Compensation Network 1) provides 100k ohm resistance and 2.2 nF capacitance and should be used with loads that are 75 μ H to 500 μ H. If this default network is not adequate for your application and load, the Compensation Network 1 switch can be turned off and the Compensation Network 2 switch can be used to enable a network that provides 100k ohm resistance and 10 nF capacitance and should be used with loads that are 500 μ H to 2 mH.

If neither compensation network is adequate for your requirements, a custom compensation network can be installed by the user in place of the through-hole components that populate the Compensation 2 network. For information on installing a custom compensation network, see Section 5.2 “**Internal Configuration.**” For more information on Controlled-Current operation, including instructions for selecting the best RC components for your network, see the topic “Controlled Current Operation” in the **Applications** section of this manual.

NOTE: Enable ONLY Compensation Network 2 (SW#5) or Compensation Network 1 (SW#6). Both compensation networks should NOT be enabled simultaneously.

SW#6: Compensation Network 1

When the 8700 series amplifier is used in Controlled-Current mode, the current control loop is tuned with an RC network. The Compensation Network 1 switch enables the factory default RC network. This provides 100k ohm resistance and

2.2 nF capacitance and should be used with loads that are 75 μ H to 500 μ H. If this default network is not adequate for your application and load, the Compensation Network 1 switch can be turned off and the Compensation Network 2 switch can be used to enable a network that provides 100k ohm resistance and 10 nF capacitance and should be used with loads that are 500 μ H to 2 mH.

If neither compensation network is adequate for your requirements, a custom compensation network can be installed by the user in place of the through-hole components that populate the Compensation 2 network. For information on installing a custom compensation network, see Section 5.2 “**Internal Configuration.**” For more information on Controlled-Current operation, including instructions for selecting the best RC components for your network, see the topic “Controlled Current Operation” in the **Applications** section of this manual.

NOTE: Enable ONLY Compensation Network 2 (SW#5) or Compensation Network 1 (SW#6). Both compensation networks should NOT be enabled simultaneously.

SW#7: Control Configuration

IMPORTANT: Do not change the Control Configuration switch on any 8700 series amplifier Master or Follower module unless instructed by AE Techron Technical Support. Product failure could occur.

When this switch is in the UP position, the amplifier module functions as a Master amplifier module. When this switch is in the DOWN position, the amplifier module functions as a Follower amplifier module.

SW#8: Coupling

When the Coupling DIP switch is in the UP position (default), the amplifier can receive and amplify both DC and AC signal. When this switch is in the DOWN position, a 30-Hz high-pass filter on the inputs prevents the transmission of DC signal.

SW#9 – SW#16: Gain

The amplifier gain can be adjusted from 0.16 to 40 in increments of 0.16 using switches 9 through 16.

All switches are additive and provide the following values toward the total Gain amount.

- SW#9 = 20.00 SW#13 = 1.25
- SW#10 = 10.00 SW#14 = 0.63
- SW#11 = 5.00 SW#15 = 0.31
- SW#12 = 2.50 SW#16 = 0.16

Refer to the chart in **Appendix A** to quickly determine the switch settings for your desired amplifier gain.

SW#17: Electronic Gain Matching

IMPORTANT: Do not change the Electronic Gain Matching switch on any 8700 series amplifier Master or Follower module unless instructed by AE Techron Technical Support. Product failure could occur.

The Electronic Gain Matching function serves to minimize circulating currents when multiple amplifier modules are used in a parallel configuration. When enabled, the Electronic Gain Matching function progressively increases impedance from the voltage gain as current increases, up to a maximum 0.20-ohm increase. This allows the amplifier modules to operate in parallel without the use of separate ballast resistors.

When the Electronic Gain Matching DIP switch is in the DOWN position, the function is disabled. When this switch is in the UP position (default), Gain Matching is enabled.

SW#18 - SW#20: Synthetic Impedance

These three switches allow the addition of a synthetic impedance on the output of the amplifier. Synthetic Impedance can be used to increase stability when driving capacitive loads. It can also be used in testing where the effect of long power lines needs to be simulated (such as for power utility applications).

When all four switches are in the DOWN position (default), Synthetic Impedance is disabled. The synthetic impedance can be added in increments of 0.125 ohms by setting one or more of the synthetic impedance switches in the UP position. Refer to **Figure 5.3** for all available synthetic impedance switch settings.

ON = DIP Switch UP OFF = DIP Switch DOWN			
SW#18	SW#19	SW#20	Synthetic Impedance
ON	ON	ON	0.875Ω
ON	ON	OFF	0.750Ω
ON	OFF	ON	0.625Ω
ON	OFF	OFF	0.500Ω
OFF	ON	ON	0.375Ω
OFF	ON	OFF	0.250Ω
OFF	OFF	ON	0.125Ω
OFF	OFF	OFF	0.00Ω

Figure 5.3 – Synthetic Impedance Switch Configurations

SW#21 - #24: Current Limit

These four switches control the current-limit settings for the amplifier. When all four switches are in the UP position (default), the amplifier's output current is limited to 160A. The current-limit can be lowered in 10A increments by setting one or more of the current limit switches in the DOWN position. Refer to **Figure 5.4** for all available current-limit switch settings.

NOTE: If all four current-limit DIP switches are set in the DOWN position, the amplifier's output current will be limited to 10A.

ON = DIP Switch UP OFF = DIP Switch DOWN				
SW#21	SW#22	SW#23	SW#24	Current Limit
ON	ON	ON	ON	160A
ON	ON	ON	OFF	150A
ON	ON	OFF	ON	140A
ON	ON	OFF	OFF	130A
ON	OFF	ON	ON	120A
ON	OFF	ON	OFF	110A
ON	OFF	OFF	ON	100A
ON	OFF	OFF	OFF	90A
OFF	ON	ON	ON	80A
OFF	ON	ON	OFF	70A
OFF	ON	OFF	ON	60A
OFF	ON	OFF	OFF	50A
OFF	OFF	ON	ON	40A
OFF	OFF	ON	OFF	30A
OFF	OFF	OFF	ON	20A
OFF	OFF	OFF	OFF	10A

Figure 5.4 – Current Limit Switch Configurations

6 Applications

6.1 Controlled-Current Operation

6.1.1 Controlled-Voltage vs. Controlled-Current Modes of Operation

AE Techron 8700 series amplifiers can be field-configured to operate as **Voltage Amplifiers** (Voltage-Controlled Voltage Source) or as **Trans-conductance Amplifiers** (Voltage-Controlled Current Source). The mode selection is made via the back-panel DIP switch #4. See the **Advanced Configuration** section for more information.

When configured as a **Controlled-Voltage** source (voltage amplifier), the amplifier will provide an output voltage that is constant and proportional to the control (input) voltage. If the load's impedance changes, the amplifier will seek to maintain this ratio of input to output voltage by increasing or decreasing the current it produces, as long as it is within the amplifier's ability to create the required current. Use this mode if you want the output voltage waveform to be like the input waveform (see **Figure 6.1**).

Conversely, when configured as a **Controlled-Current** source (transconductance amplifier), the amplifier will provide an output current that is constant and proportional to the control (input) voltage. If the load's impedance changes, the amplifier will seek to maintain this transconductance (ratio of input voltage to output current) by increasing or decreasing the voltage it produces, as long as it is within the amplifier's ability to create the required voltage. Use this mode if you want the output current waveform to be like the input waveform (see **Figure 6.2**).

6.1.2 Safety and Operation Considerations for Controlled Current Operation

When an AE Techron amplifier is configured as a Controlled-Current source, care needs to be exercised in its operation. **Any voltage controlled current source should never be turned on without a load, (with some impedance, real or effective) connected to its output terminals.**

CONTROLLED-VOLTAGE MODE

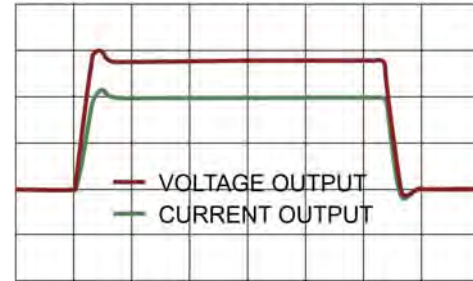

Figure 6.1 – Input to Output Comparison, Controlled-Voltage Operation

CONTROLLED-CURRENT MODE

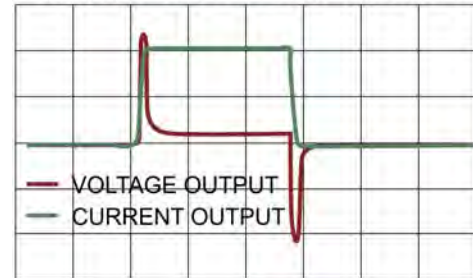

Figure 6.2 – Input to Output Comparison, Controlled-Current Operation

When asked to operate in this way, any current source (including an AE Techron amplifier) will increase its output voltage in an attempt to drive the requested current into the load. In an open-circuit condition, creating current flow will be impossible. The current source will increase its output voltage until it reaches its voltage limit. This is a potentially dangerous condition for both the AE Techron amplifier and for any user who might come in contact with the amplifier output terminals.

Likewise, operation in Controlled Current mode into a load that is completely resistive is **NOT recommended**. The load must have some inductance for Controlled Current mode to operate correctly.

When operating in Controlled-Current (CC) mode, a compensation circuit is required to ensure accurate output current. Since the load is a critical circuit component in CC mode, the inductive and resistive values of the load will determine the required compensation values. While one of the two compensation settings that can be enabled

with DIP switch settings will be sufficient for many applications, this compensation setting may also be adjusted in the field by installing a custom compensation network. The following section describes methods for determining proper compensation requirements when operating in Controlled-Current mode.

6.1.3 Controlling Compensation for CC Operation

AE Techron 8700 series amplifiers can be configured for either Controlled Voltage (CV) or Controlled Current (CC) mode of operation. When operating the amplifier in Controlled Voltage (CV) mode, compensation is not required. However, when operating in Controlled Current (CC) mode, the amplifier load becomes an integral part of the system. In order to ensure system stability and to control available bandwidth, compensation via an RC network is required for CC operation. The following steps will show you how to determine the proper compensation values for your load to allow you to operate your amplifier in CC mode safely and effectively.

STEP 1: Check Amplifier Operation in CV mode.

We recommend that you power-up and enable the amplifier in Controlled Voltage mode without at-

taching a load before configuring your amplifier for Controlled Current operation. This will allow you to verify that the input signal and the amplifier are operating correctly.

Once this initial check is completed, power down the amplifier, attach your load, and move the Operation Mode DIP switch (SW#4, located on the Master amplifier module's back panel) to the DOWN position to place the amplifier in CC mode.

STEP 2: Determine Required Compensation.

When operating an amplifier in Controlled-Current mode, the load becomes an integral part of the system. In order to determine the required compensation for your load, consulting the following table to determine the approximate compensation capacitance (CC) required based on the inductance of your load. Note that these calculations are based on empirical measurements and are approximate.

NOTE: Load Resistance (R) is assumed to be <5 ohms.

Load Inductance (L)	Compensation Capacitance (CC)	Compensation Network
75 μ H to 1 mH	0.0022 μ F	Network 1
1 mH to 5 mH	0.0100 μ F	Network 2

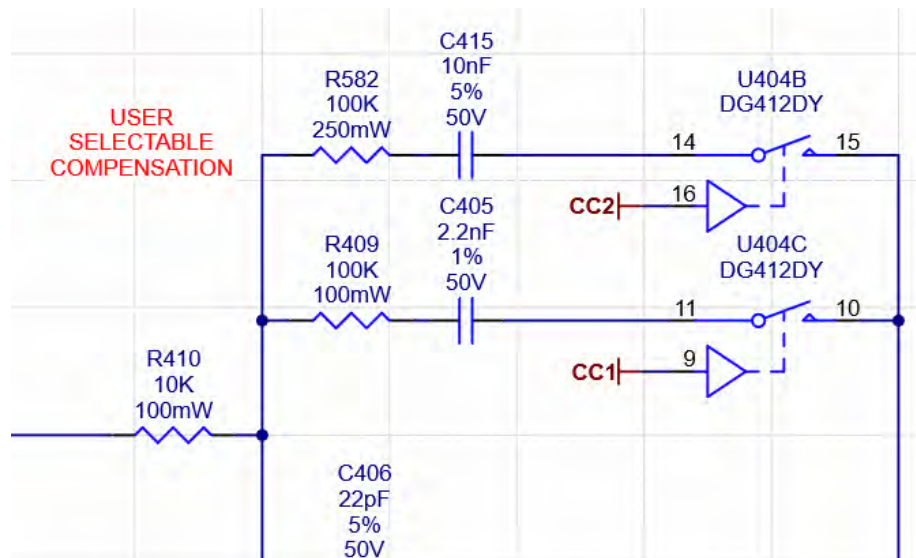

Figure 6.3 – Selectable factory-installed compensation networks

STEP 3: Enable Compensation Network

If your load inductance is between 75 μ H and 1 mH, and your load resistance is less than 5 ohms, then you can likely use Compensation Network 1 for your application. If your load inductance is between 1 mH and 5 mH, and your load resistance is less than 5 ohms, then you can likely use Compensation Network 2 for your application. (See **Figure 6.3**). These compensation networks are enabled when Compensation Network 1 DIP switch (SW#6) or Compensation Network 2 DIP switch (SW#5) on the Master amplifier module is set to the ON (UP) position.

If your load inductance falls outside of these ranges, or if your load resistance is greater than 5 ohms, please contact AE Techron Technical Support for assistance.

STEP 4: Verifying Operation

Remember the load you are connecting is a part of the system and the amplifier should not be turned on without the load being connected.

After selecting and enabling your choice of Compensation Network, check to ensure that the Operation Mode DIP switch is set to CC (DOWN), then power up the amplifier without signal input.

To begin testing, input a square wave with a frequency of 100 Hz to 1 kHz, or a squared pulse at a

low level (typically 0.25 to 2.0 volts). A limited-rise-time, repetitive pulse of low duty cycle is preferred.

Observe the output current through a current monitor or current probe. Look for clean transition edges. The presence of ringing or rounding on the transition edges indicates compensation problems. (See **Figure 6.5**.)

If a change in compensation is necessary, an adjustment to the resistor component of the Compensation circuit is probably required.

If the output current waveform is ringing, the circuit is under damped: You have too much compensation and should lower the resistance (see **Figure 6.6**).

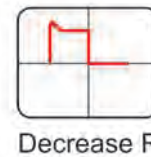

Figure 6.6 – Square Wave Showing a Decrease in R is Required

If the output current waveform is rounded, the circuit is over damped: You have too little compensation and should increase resistance (see **Figure 6.7**).

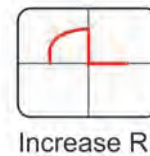

Figure 6.7 – Square Wave Showing an Increase in R is Required

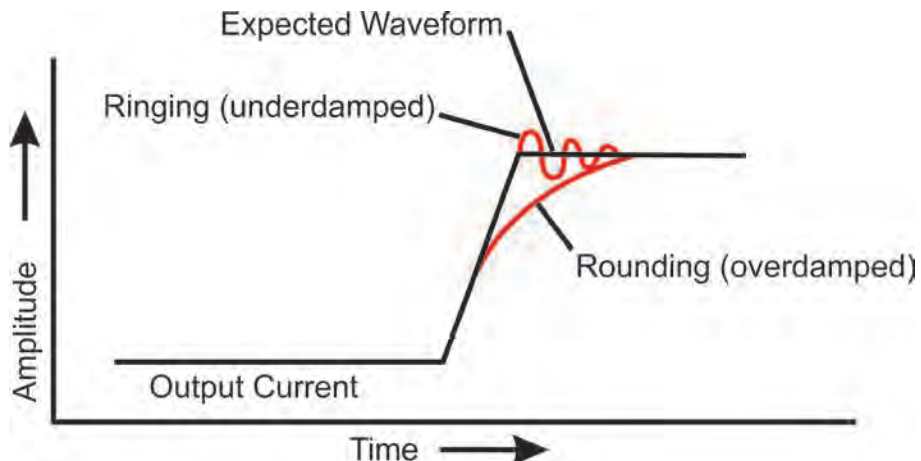

Figure 6.5 – Compensation Effects on Waveform

If the output current waveform is neither under damped or over damped, but the top of the square wave is not level, then you should instead decrease the capacitor value (see **Figure 6.8**).

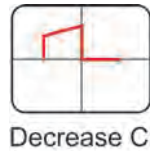

Figure 6.8 – Square Wave Showing a Decrease in C is Required

When making adjustments:

Resistor: Increase or decrease resistance values in increments of +/- 10%.

Capacitor: Incrementally decrease capacitor values by a factor of 2 or 3.

After final adjustments have been made to the circuit, the final waveform for your planned application should be tested to confirm the amplifier's compensation setting.

NOTE:

- If possible, use 1% metal film resistors. AETechron discourages installation of potentiome-

ters in the resistor location of the compensation circuit because this can decrease stability and may increase inductance.

- The parallel capacitor in the RC network serves to increase stability but can be removed, if it is not required for system stability. If the parallel capacitor is used, it will usually decrease the value of resistance needed.
- In multiple amplifier systems, expect to decrease the value of R5 in series systems by 1/2.

6.2 Driving Reactive Loads

Like all switching amplifiers, 8700 series amplifiers are able to reuse the energy returned from reactive loads. Unlike purely resistive loads, loads with some reactance (either capacitive or inductive) will store energy during part of a cycle, and then release some of this energy back later. This energy is transferred back to the load through the amplifier's power supply. This allows the amplifier to deliver continuous apparent power that is up to five times the rated power of the amplifier when driving reactive loads.

7 Maintenance

Simple maintenance can be performed by the user to help keep the equipment operational. The following routine maintenance is designed to prevent problems before they occur. See the **Troubleshooting** section, for recommendations for restoring the equipment to operation after an error condition has occurred.

Preventative maintenance is recommended after the first 250 hours of operation, and every three months or 250 hours thereafter. If the equipment environment is dirty or dusty, preventative maintenance should be performed more frequently.



7.1 Clean Amplifier Filter and Grills

7.1.1 Tools Required

The recommended equipment and supplies needed to perform the functions required for this task are described as follows.

- Vacuum cleaner
- Damp cloth (use water only or a mild soap diluted in water)

To ensure adequate cooling and maximum efficiency of the internal cooling fans, the amplifier's front and rear grills should be cleaned periodically. To clean the amplifier grills and filter, complete the following steps:

1. Turn the amplifier OFF. Disconnect the amplifier from its power source.
 2. The front grill for each amplifier module is secured to the module front panel by magnets. Pull out on the grill to release each one from the front panel.
 3. Remove the filter located behind the front grill.
 4. Using a vacuum cleaner, vacuum the front ventilation grill and the grill filter.
 5. Using a damp cloth, clean the amplifier module's front panel. Also use the damp cloth to clean the front grill and filter. If necessary, these can be immersed in warm, soapy water.
 6. Open the back access door on the amplifier. Using a vacuum cleaner, vacuum the area around the amplifier modules and the back ventilation exit grill of each module.
 7. Using a damp cloth, clean all amplifier module's rear ventilation grills.
 8. Dry the front panels, back panels, filters, and grills with a clean cloth or allow to air dry.
- IMPORTANT: All parts should be completely dry before plugging in or restarting the amplifier.**

8 Troubleshooting

8.1 Introduction & Precautions

This section provides a set of procedures for identifying and correcting problems with the 8700 series amplifier. Rather than providing an exhaustive and detailed list of troubleshooting specifications, this section aims to provide a set of short-cuts intended to get an inoperative amplifier back in service as quickly as possible.

The procedures outlined in this section are directed toward an experienced electronic technician; it assumes that the technician has knowledge of typical electronic repair and test procedures.

Please be aware that the 8700 series will undergo frequent engineering updates. As a result, modules and electronic assemblies may not be interchangeable between units. Particularly, the circuit boards undergo periodic engineering modifications that may make interchangeability between units impossible.

	<h2 style="margin: 0;">WARNING</h2>
<p>ELECTRIC SHOCK HAZARD.</p> <p>Follow these safety precautions before opening the amplifier's back access door:</p> <ul style="list-style-type: none"> • Disconnect the AC power supply. • Wait at least 3-5 minutes after disconnecting AC power before opening the access door. • Wear safety goggles. • Contact AE Techron Technical Support for any questions or concerns. 	

8.2 Visual Inspection

Before attempting to troubleshoot the amplifier while it is operating, please take time to complete a visual inspection of the internal components of the amplifier.

1. To perform a Visual Inspection, first turn the Run/Standby switch to the Standby position.
2. Disconnect the AC mains from the amplifier.

3. Wait three to five minutes for the Power Supply capacitors to discharge.
4. Open the back access door and check the following:
 - Check to make sure the breaker switch on all amplifier modules is in the ON position.
 - Inspect the modules for loose or disconnected wires or connectors.
 - Inspect the bus bars connecting the amplifier module's outputs for any signs of charring or melting.
 - Inspect the entire lengths of wires and cables for breaks or other physical damage.
5. If there is any physical damage to the amplifier, please return it to AE Techron for repair.

8.3 No Signal

Missing Output signal may be caused by one of the following:

1. The Control Configuration DIP switch (#7) on the Master amplifier module is set to the Follower (down) position. This DIP switch should be set to the Master (up) position. See the **Advanced Configuration** section in this manual for more information.
2. A signal source is not connected to either inputs on the amplifier. See the **Amplifier Setup** section in this manual for more information.

8.4 No LEDs Illuminated

If none of the LEDs on the Display Panel are illuminated, check the following:

1. The AC mains are not connected or not on (see the **Amplifier Setup** section for more information).

8.5 Over/Under Line LED Lit

The amplifier will protect itself from AC mains voltage that is 10% above or below the voltage indicated on the back panel. If the AC mains voltage is more than 10% outside the range of the operating voltage, increase or reduce the AC mains voltage to the proper level. When the line voltage condition is corrected, the amplifier will automatically return to Run mode. If the amplifier does not reset, the

amplifier's internal transformers may need to be replaced. Please see the **Factory Service** information at the end of this section.

8.6 Run/Standby LED Remains Amber

When the Run/Standby LED is lit solid amber, the amplifier is in Standby mode. Press the Power switch to the ON position to place the amplifier in Run mode.

If the amplifier does not return to run mode, check to see if the High/Low Line, Overtemp, or Fault LEDs are lit, and then follow the instructions in this section for remedying the fault condition and returning the amplifier to Run mode.

If the remedies given fail to restart the amplifier, the amplifier may require servicing. See the Factory Service Information at the end of this section.

8.7 Amplifier Overheats (Over Temp Fault Condition)

There are two possible reasons why the 8700 series amplifier is overheating: Excessive power requirements or inadequate airflow.

8.7.1 Excessive Power Requirements

An amplifier will overheat if the required power exceeds the amplifier's capabilities. High duty cycles and low-impedance loads are especially prone to cause overheating. To see if excess power requirements are causing overheating, check the following:

1. The application's power requirements fall within the specifications of the amplifier. See the amplifier's **Specifications** sheet.
2. Faulty output connections and load.
3. Undesired DC offset at the Output and Input signal.

If the amplifier chronically overheats with suitable power/load conditions, then the amplifier may not be receiving adequate airflow. To check for adequate airflow, proceed with the following steps:

8.7.2 Check for Inadequate Airflow

1. Check air filters. Over time they can become dirty and worn out. It is a good idea to clean the air filters periodically with a mild detergent and water.
2. Visually inspect fans to assure correct operation while amplifier is On (I). When an OverTemp fault occurs, the amplifier fans will automatically be placed in continuous high-speed operation. Any inoperative, visibly slow, or reverse-spinning fan should be replaced. Please see the Factory Service information at the end of this section.

An OverTemp condition places the amplifier in Standby mode. If the OverTemp pulse is extremely short, as in the case of defective wiring or switches, the OverTemp pulse may be too brief to observe.

8.7.3 Resetting After OverTemp

To reset the amplifier after an OverTemp has occurred, make sure fans are running (the amplifier fans should switch to high-speed operation when an OverTemp fault occurs). Remove the input signal from the amplifier and allow the fans to run until the amplifier has cooled sufficiently and the amplifier automatically returns to Run mode..

NOTE: Typically, overheating that occurs in the amplifier outputs due to inadequate airflow or very low impedance loads will clear within 5 minutes. Overheating in the amplifier transformers due to excessive power requirements will take from 5 to 15 minutes to clear. Timing the cool-down period for the amplifier may help to determine the cause of the overheating.

If the fault condition does not clear, return the amplifier for Factory Service.

8.8 Fault LED is Illuminated

The 8700 series amplifier contains protection circuitry that disables the amplifier if an output stage is behaving abnormally. This usually indicates an output transistor has shorted.

To clear the Fault condition, follow these steps:

1. Turn off the signal source.
2. Turn off the AC mains.
3. Turn AC mains power back on. If the Fault LED doesn't illuminate again, press the Power switch to place the amplifier in Run mode and turn the signal source on.
4. If the Fault LED is still illuminated and the Fault condition doesn't clear, return the amplifier for Factory Service. See the Factory Service information at the end of this section.

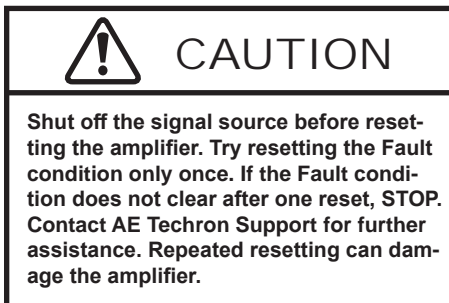

8.9 Factory Service

If the troubleshooting procedures are unsuccessful, the amplifier may need to be returned for Factory Service. All units under warranty will be serviced free of charge (customer is responsible for one-way shipping charges as well as any custom fees, duties, and/or taxes). Please review the Warranty at the beginning of this manual for more information.

All service units must be given Return Authorization by AE Techron, Inc. before being returned. Return Authorizations can be requested on our website or by contacting our Customer Service Department.

Please take extra care when packaging your amplifier for repair. It should be returned in its original packaging or a suitable alternative. Replacement packaging materials can be purchased from AE Techron for a nominal fee.

Please send all service units to the following address and be sure to include your Return Authorization Number on the box.

**AE Techron, Inc.
Attn: Service Department / RMA#
2507 Warren Street
Elkhart, IN 46516**

Appendix A: Gain DIP Switch Settings

Use this chart to determine the required settings for DIP switches 9 through 16 to achieve the amplifier gain you need for your application. Note: All

switches ON = Gain of 39.85, all switches OFF = gain of 0 (signal will not be amplified).

ON = DIP Switch UP OFF = DIP Switch DOWN								
SW#9	SW#10	SW#11	SW#12	SW#13	SW#14	SW#15	SW#16	Gain
ON	ON	ON	ON	ON	ON	ON	ON	39.85
ON	ON	ON	ON	ON	ON	ON	OFF	39.69
ON	ON	ON	ON	ON	ON	OFF	ON	39.54
ON	ON	ON	ON	ON	ON	OFF	OFF	39.38
ON	ON	ON	ON	ON	OFF	ON	ON	39.22
ON	ON	ON	ON	ON	OFF	ON	OFF	39.06
ON	ON	ON	ON	ON	OFF	OFF	ON	38.91
ON	ON	ON	ON	ON	OFF	OFF	OFF	38.75
ON	ON	ON	ON	OFF	ON	ON	ON	38.60
ON	ON	ON	ON	OFF	ON	ON	OFF	38.44
ON	ON	ON	ON	OFF	ON	OFF	ON	38.29
ON	ON	ON	ON	OFF	ON	OFF	OFF	38.13
ON	ON	ON	ON	OFF	OFF	ON	ON	37.97
ON	ON	ON	ON	OFF	OFF	ON	OFF	37.81
ON	ON	ON	ON	OFF	OFF	OFF	ON	37.66
ON	ON	ON	ON	OFF	OFF	OFF	OFF	37.50
ON	ON	ON	OFF	ON	ON	ON	ON	37.35
ON	ON	ON	OFF	ON	ON	ON		37.19
ON	ON	ON	OFF	ON	ON		ON	37.04
ON	ON	ON	OFF	ON	ON			36.88
ON	ON	ON	OFF	ON	OFF	ON	ON	36.72
ON	ON	ON	OFF	ON	OFF	ON		36.56
ON	ON	ON	OFF	ON	OFF	OFF	ON	36.41
ON	ON	ON	OFF	ON	OFF	OFF	OFF	36.25
ON	ON	ON	OFF	OFF	ON	ON	ON	36.10
ON	ON	ON	OFF	OFF	ON	ON		35.94
ON	ON	ON	OFF	OFF	ON		ON	35.79
ON	ON	ON	OFF	OFF	ON			35.63
ON	ON	ON	OFF	OFF	OFF	ON	ON	35.47
ON	ON	ON	OFF	OFF	OFF	ON		35.31
ON	ON	ON	OFF	OFF	OFF	OFF	ON	35.16
ON	ON	ON	OFF	OFF	OFF	OFF	OFF	35.00
ON	ON	OFF	ON	ON	ON	ON	ON	34.85
ON	ON	OFF	ON	ON	ON	ON	OFF	34.69
ON	ON	OFF	ON	ON	ON	OFF	ON	34.54
ON	ON	OFF	ON	ON	ON	OFF	OFF	34.38
ON	ON	OFF	ON	ON	OFF	ON	ON	34.22
ON	ON	OFF	ON	ON	OFF	ON	OFF	34.06
ON	ON	OFF	ON	ON	OFF	OFF	ON	33.91
ON	ON	OFF	ON	ON	OFF	OFF	OFF	33.75
ON	ON	OFF	ON	OFF	ON	ON	ON	33.60
ON	ON	OFF	ON	OFF	ON	ON	OFF	33.44

ON = DIP Switch UP OFF = DIP Switch DOWN								
SW#9	SW#10	SW#11	SW#12	SW#13	SW#14	SW#15	SW#16	Gain
ON	ON	OFF	ON	OFF	ON	OFF	ON	33.29
ON	ON	OFF	ON	OFF	ON	OFF	OFF	33.13
ON	ON	OFF	ON	OFF	OFF	ON	ON	32.97
ON	ON	OFF	ON	OFF	OFF	ON	OFF	32.81
ON	ON	OFF	ON	OFF	OFF	OFF	ON	32.66
ON	ON	OFF	ON	OFF	OFF	OFF	OFF	32.50
ON	ON	OFF	OFF	ON	ON	ON	ON	32.35
ON	ON	OFF	OFF	ON	ON	ON		32.19
ON	ON	OFF	OFF	ON	ON		ON	32.04
ON	ON	OFF	OFF	ON	ON			31.88
ON	ON	OFF	OFF	ON	OFF	ON	ON	31.72
ON	ON	OFF	OFF	ON	OFF	ON		31.56
ON	ON	OFF	OFF	ON	OFF	OFF	ON	31.41
ON	ON	OFF	OFF	ON	OFF	OFF	OFF	31.25
ON	ON	OFF	OFF	OFF	ON	ON	ON	31.10
ON	ON	OFF	OFF	OFF	ON	ON		30.94
ON	ON	OFF	OFF	OFF	ON		ON	30.79
ON	ON	OFF	OFF	OFF	ON			30.63
ON	ON	OFF	OFF	OFF	OFF	ON	ON	30.47
ON	ON	OFF	OFF	OFF	OFF	ON		30.31
ON	ON	OFF	OFF	OFF	OFF	OFF	ON	30.16
ON	ON	OFF	OFF	OFF	OFF	OFF	OFF	30.00
ON	OFF	ON	ON	ON	ON	ON	ON	29.85
ON	OFF	ON	ON	ON	ON	ON	OFF	29.69
ON	OFF	ON	ON	ON	ON	OFF	ON	29.54
ON	OFF	ON	ON	ON	ON	OFF	OFF	29.38
ON	OFF	ON	ON	ON	OFF	ON	ON	29.22
ON	OFF	ON	ON	ON	OFF	ON	OFF	29.06
ON	OFF	ON	ON	ON	OFF	OFF	ON	28.91
ON	OFF	ON	ON	ON	OFF	OFF	OFF	28.75
ON	OFF	ON	ON	OFF	ON	ON	ON	28.60
ON	OFF	ON	ON	OFF	ON	ON	OFF	28.44
ON	OFF	ON	ON	OFF	ON	OFF	ON	28.29
ON	OFF	ON	ON	OFF	ON	OFF	OFF	28.13
ON	OFF	ON	ON	OFF	OFF	ON	ON	27.97
ON	OFF	ON	ON	OFF	OFF	ON	OFF	27.81
ON	OFF	ON	ON	OFF	OFF	OFF	ON	27.66
ON	OFF	ON	ON	OFF	OFF	OFF	OFF	27.50
ON	OFF	ON	OFF	ON	ON	ON	ON	27.35
ON	OFF	ON	OFF	ON	ON	ON	OFF	27.19
ON	OFF	ON	OFF	ON	ON	OFF	ON	27.04
ON	OFF	ON	OFF	ON	ON	OFF	OFF	26.88
ON	OFF	ON	OFF	ON	OFF	ON	ON	26.72
ON	OFF	ON	OFF	ON	OFF	ON	OFF	26.56
ON	OFF	ON	OFF	ON	OFF	OFF	ON	26.41
ON	OFF	ON	OFF	ON	OFF	OFF	OFF	26.25
ON	OFF	ON	OFF	OFF	ON	ON	ON	26.10
ON	OFF	ON	OFF	OFF	ON	ON	OFF	25.94
ON	OFF	ON	OFF	OFF	ON	OFF	ON	25.79

ON = DIP Switch UP OFF = DIP Switch DOWN								
SW#9	SW#10	SW#11	SW#12	SW#13	SW#14	SW#15	SW#16	Gain
ON	OFF	ON	OFF	OFF	ON	OFF	OFF	25.63
ON	OFF	ON	OFF	OFF	OFF	ON	ON	25.47
ON	OFF	ON	OFF	OFF	OFF	ON	OFF	25.31
ON	OFF	ON	OFF	OFF	OFF	OFF	ON	25.16
ON	OFF	ON	OFF	OFF	OFF	OFF	OFF	25.00
ON	OFF	OFF	ON	ON	ON	ON	ON	24.85
ON	OFF	OFF	ON	ON	ON	ON	OFF	24.69
ON	OFF	OFF	ON	ON	ON	OFF	ON	24.54
ON	OFF	OFF	ON	ON	ON	OFF	OFF	24.38
ON	OFF	OFF	ON	ON	OFF	ON	ON	24.22
ON	OFF	OFF	ON	ON	OFF	ON	OFF	24.06
ON	OFF	OFF	ON	ON	OFF	OFF	ON	23.91
ON	OFF	OFF	ON	ON	OFF	OFF	OFF	23.75
ON	OFF	OFF	ON	OFF	ON	ON	ON	23.60
ON	OFF	OFF	ON	OFF	ON	ON	OFF	23.44
ON	OFF	OFF	ON	OFF	ON	OFF	ON	23.29
ON	OFF	OFF	ON	OFF	ON	OFF	OFF	23.13
ON	OFF	OFF	ON	OFF	OFF	ON	ON	22.97
ON	OFF	OFF	ON	OFF	OFF	ON	OFF	22.81
ON	OFF	OFF	ON	OFF	OFF	OFF	ON	22.66
ON	OFF	OFF	ON	OFF	OFF	OFF	OFF	22.50
ON	OFF	OFF	OFF	ON	ON	ON	ON	22.35
ON	OFF	OFF	OFF	ON	ON	ON		22.19
ON	OFF	OFF	OFF	ON	ON		ON	22.04
ON	OFF	OFF	OFF	ON	ON			21.88
ON	OFF	OFF	OFF	ON	OFF	ON	ON	21.72
ON	OFF	OFF	OFF	ON	OFF	ON		21.56
ON	OFF	OFF	OFF	ON	OFF	OFF	ON	21.41
ON	OFF	OFF	OFF	ON	OFF	OFF	OFF	21.25
ON	OFF	OFF	OFF	OFF	ON	ON	ON	21.10
ON	OFF	OFF	OFF	OFF	ON	ON		20.94
ON	OFF	OFF	OFF	OFF	ON		ON	20.79
ON	OFF	OFF	OFF	OFF	ON			20.63
ON	OFF	OFF	OFF	OFF	OFF	ON	ON	20.47
ON	OFF	OFF	OFF	OFF	OFF	ON		20.31
ON	OFF	OFF	OFF	OFF	OFF	OFF	ON	20.16
ON	OFF	OFF	OFF	OFF	OFF	OFF	OFF	20.00
OFF	ON	ON	ON	ON	ON	ON	ON	19.85
OFF	ON	ON	ON	ON	ON	ON	OFF	19.69
OFF	ON	ON	ON	ON	ON	OFF	ON	19.54
OFF	ON	ON	ON	ON	ON	OFF	OFF	19.38
OFF	ON	ON	ON	ON	OFF	ON	ON	19.22
OFF	ON	ON	ON	ON	OFF	ON	OFF	19.06
OFF	ON	ON	ON	ON	OFF	OFF	ON	18.91
OFF	ON	ON	ON	ON	OFF	OFF	OFF	18.75
OFF	ON	ON	ON	OFF	ON	ON	ON	18.60
OFF	ON	ON	ON	OFF	ON	ON	OFF	18.44
OFF	ON	ON	ON	OFF	ON	OFF	ON	18.29
OFF	ON	ON	ON	OFF	ON	OFF	OFF	18.13

ON = DIP Switch UP OFF = DIP Switch DOWN								
SW#9	SW#10	SW#11	SW#12	SW#13	SW#14	SW#15	SW#16	Gain
OFF	ON	ON	ON	OFF	OFF	ON	ON	17.97
OFF	ON	ON	ON	OFF	OFF	ON	OFF	17.81
OFF	ON	ON	ON	OFF	OFF	OFF	ON	17.66
OFF	ON	ON	ON	OFF	OFF	OFF	OFF	17.50
OFF	ON	ON	OFF	ON	ON	ON	ON	17.35
OFF	ON	ON	OFF	ON	ON	ON	OFF	17.19
OFF	ON	ON	OFF	ON	ON	OFF	ON	17.04
OFF	ON	ON	OFF	ON	ON	OFF	OFF	16.88
OFF	ON	ON	OFF	ON	OFF	ON	ON	16.72
OFF	ON	ON	OFF	ON	OFF	ON	OFF	16.56
OFF	ON	ON	OFF	ON	OFF	OFF	ON	16.41
OFF	ON	ON	OFF	ON	OFF	OFF	OFF	16.25
OFF	ON	ON	OFF	OFF	ON	ON	ON	16.10
OFF	ON	ON	OFF	OFF	ON	ON	OFF	15.94
OFF	ON	ON	OFF	OFF	ON	OFF	ON	15.79
OFF	ON	ON	OFF	OFF	ON	OFF	OFF	15.63
OFF	ON	ON	OFF	OFF	OFF	ON	ON	15.47
OFF	ON	ON	OFF	OFF	OFF	ON	OFF	15.31
OFF	ON	ON	OFF	OFF	OFF	OFF	ON	15.16
OFF	ON	ON	OFF	OFF	OFF	OFF	OFF	15.00
OFF	ON	OFF	ON	ON	ON	ON	ON	14.85
OFF	ON	OFF	ON	ON	ON	ON	OFF	14.69
OFF	ON	OFF	ON	ON	ON	OFF	ON	14.54
OFF	ON	OFF	ON	ON	ON	OFF	OFF	14.38
OFF	ON	OFF	ON	ON	OFF	ON	ON	14.22
OFF	ON	OFF	ON	ON	OFF	ON	OFF	14.06
OFF	ON	OFF	ON	ON	OFF	OFF	ON	13.91
OFF	ON	OFF	ON	ON	OFF	OFF	OFF	13.75
OFF	ON	OFF	ON	OFF	ON	ON	ON	13.60
OFF	ON	OFF	ON	OFF	ON	ON	OFF	13.44
OFF	ON	OFF	ON	OFF	ON	OFF	ON	13.29
OFF	ON	OFF	ON	OFF	ON	OFF	OFF	13.13
OFF	ON	OFF	ON	OFF	OFF	ON	ON	12.97
OFF	ON	OFF	ON	OFF	OFF	ON	OFF	12.81
OFF	ON	OFF	ON	OFF	OFF	OFF	ON	12.66
OFF	ON	OFF	ON	OFF	OFF	OFF	OFF	12.50
OFF	ON	OFF	ON	ON	ON	ON	ON	12.35
OFF	ON	OFF	OFF	ON	ON	ON	OFF	12.19
OFF	ON	OFF	OFF	ON	ON	OFF	ON	12.04
OFF	ON	OFF	OFF	ON	ON	OFF	OFF	11.88
OFF	ON	OFF	OFF	ON	OFF	ON	ON	11.72
OFF	ON	OFF	OFF	ON	OFF	ON	OFF	11.56
OFF	ON	OFF	OFF	ON	OFF	OFF	ON	11.41
OFF	ON	OFF	OFF	ON	OFF	OFF	OFF	11.25
OFF	ON	OFF	OFF	OFF	ON	ON	ON	11.10
OFF	ON	OFF	OFF	OFF	ON	ON	OFF	10.94
OFF	ON	OFF	OFF	OFF	ON	OFF	ON	10.79
OFF	ON	OFF	OFF	OFF	ON	OFF	OFF	10.63
OFF	ON	OFF	OFF	OFF	OFF	ON	ON	10.47

ON = DIP Switch UP OFF = DIP Switch DOWN								
SW#9	SW#10	SW#11	SW#12	SW#13	SW#14	SW#15	SW#16	Gain
OFF	ON	OFF	OFF	OFF	OFF	ON	OFF	10.31
OFF	ON	OFF	OFF	OFF	OFF	OFF	ON	10.16
OFF	ON	OFF	OFF	OFF	OFF	OFF	OFF	10.00
OFF	OFF	ON	ON	ON	ON	ON	ON	9.85
OFF	OFF	ON	ON	ON	ON	ON	OFF	9.69
OFF	OFF	ON	ON	ON	ON	OFF	ON	9.54
OFF	OFF	ON	ON	ON	ON	OFF	OFF	9.38
OFF	OFF	ON	ON	ON	OFF	ON	ON	9.22
OFF	OFF	ON	ON	ON	OFF	ON	OFF	9.06
OFF	OFF	ON	ON	ON	OFF	OFF	ON	8.91
OFF	OFF	ON	ON	ON	OFF	OFF	OFF	8.75
OFF	OFF	ON	ON	OFF	ON	ON	ON	8.60
OFF	OFF	ON	ON	OFF	ON	ON	OFF	8.44
OFF	OFF	ON	ON	OFF	ON	OFF	ON	8.29
OFF	OFF	ON	ON	OFF	ON	OFF	OFF	8.13
OFF	OFF	ON	ON	OFF	OFF	ON	ON	7.97
OFF	OFF	ON	ON	OFF	OFF	ON	OFF	7.81
OFF	OFF	ON	ON	OFF	OFF	OFF	ON	7.66
OFF	OFF	ON	ON	OFF	OFF	OFF	OFF	7.50
OFF	OFF	ON	OFF	ON	ON	ON	ON	7.35
OFF	OFF	ON	OFF	ON	ON	ON	OFF	7.19
OFF	OFF	ON	OFF	ON	ON	OFF	ON	7.04
OFF	OFF	ON	OFF	ON	ON	OFF	OFF	6.88
OFF	OFF	ON	OFF	ON	OFF	ON	ON	6.72
OFF	OFF	ON	OFF	ON	OFF	ON	OFF	6.56
OFF	OFF	ON	OFF	ON	OFF	OFF	ON	6.41
OFF	OFF	ON	OFF	ON	OFF	OFF	OFF	6.25
OFF	OFF	ON	OFF	OFF	ON	ON	ON	6.10
OFF	OFF	ON	OFF	OFF	ON	ON	OFF	5.94
OFF	OFF	ON	OFF	OFF	ON	OFF	ON	5.79
OFF	OFF	ON	OFF	OFF	ON	OFF	OFF	5.63
OFF	OFF	ON	OFF	OFF	OFF	ON	ON	5.47
OFF	OFF	ON	OFF	OFF	OFF	ON	OFF	5.31
OFF	OFF	ON	OFF	OFF	OFF	OFF	ON	5.16
OFF	OFF	ON	OFF	OFF	OFF	OFF	OFF	5.00
OFF	OFF	OFF	ON	ON	ON	ON	ON	4.85
OFF	OFF	OFF	ON	ON	ON	ON	OFF	4.69
OFF	OFF	OFF	ON	ON	ON	OFF	ON	4.54
OFF	OFF	OFF	ON	ON	ON	OFF	OFF	4.38
OFF	OFF	OFF	ON	ON	OFF	ON	ON	4.22
OFF	OFF	OFF	ON	ON	OFF	ON	OFF	4.06
OFF	OFF	OFF	ON	ON	OFF	OFF	ON	3.91
OFF	OFF	OFF	ON	ON	OFF	OFF	OFF	3.75
OFF	OFF	OFF	ON	OFF	ON	ON	ON	3.60
OFF	OFF	OFF	ON	OFF	ON	ON	OFF	3.44
OFF	OFF	OFF	ON	OFF	ON	OFF	ON	3.29
OFF	OFF	OFF	ON	OFF	ON	OFF	OFF	3.13
OFF	OFF	OFF	ON	OFF	OFF	ON	ON	2.97
OFF	OFF	OFF	ON	OFF	OFF	ON	OFF	2.81

ON = DIP Switch UP OFF = DIP Switch DOWN								
SW#9	SW#10	SW#11	SW#12	SW#13	SW#14	SW#15	SW#16	Gain
OFF	OFF	OFF	ON	OFF	OFF	OFF	ON	2.66
OFF	OFF	OFF	ON	OFF	OFF	OFF	OFF	2.50
OFF	OFF	OFF	OFF	ON	ON	ON	ON	2.35
OFF	OFF	OFF	OFF	ON	ON	ON	OFF	2.19
OFF	OFF	OFF	OFF	ON	ON	OFF	ON	2.04
OFF	OFF	OFF	OFF	ON	ON	OFF	OFF	1.88
OFF	OFF	OFF	OFF	ON	OFF	ON	ON	1.72
OFF	OFF	OFF	OFF	ON	OFF	ON	OFF	1.56
OFF	OFF	OFF	OFF	ON	OFF	OFF	ON	1.41
OFF	OFF	OFF	OFF	ON	OFF	OFF	OFF	1.25
OFF	OFF	OFF	OFF	OFF	ON	ON	ON	1.10
OFF	OFF	OFF	OFF	OFF	ON	ON	OFF	0.94
OFF	OFF	OFF	OFF	OFF	ON	OFF	ON	0.79
OFF	OFF	OFF	OFF	OFF	ON	OFF	OFF	0.63
OFF	OFF	OFF	OFF	OFF	OFF	ON	ON	0.47
OFF	OFF	OFF	OFF	OFF	OFF	ON	OFF	0.31
OFF	OFF	OFF	OFF	OFF	OFF	OFF	ON	0.16
OFF	OFF	OFF	OFF	OFF	OFF	OFF	OFF	0

Appendix B: Amplifier Module Wiring Diagrams

8708 (208V) WIRING DIAGRAM

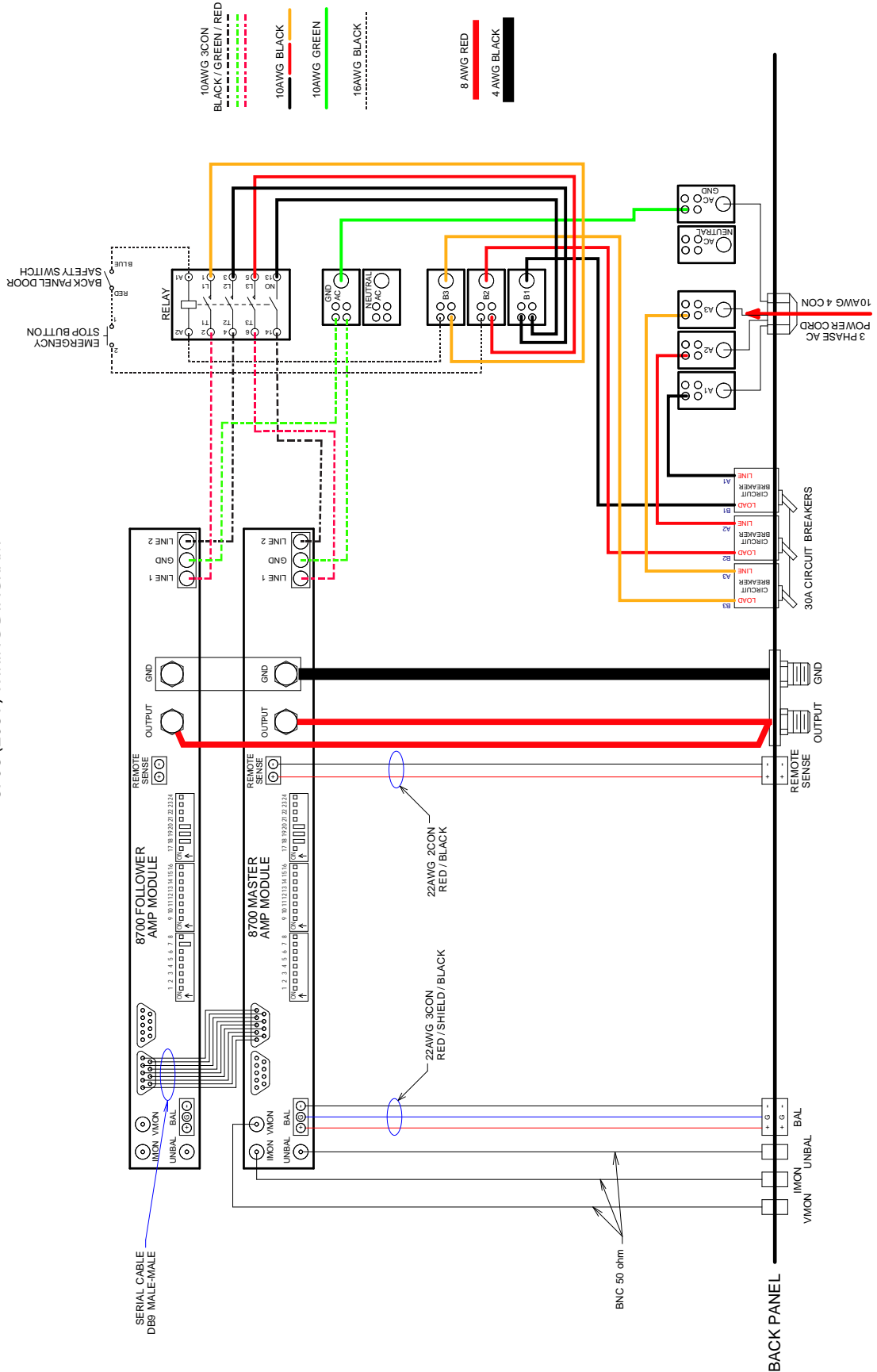

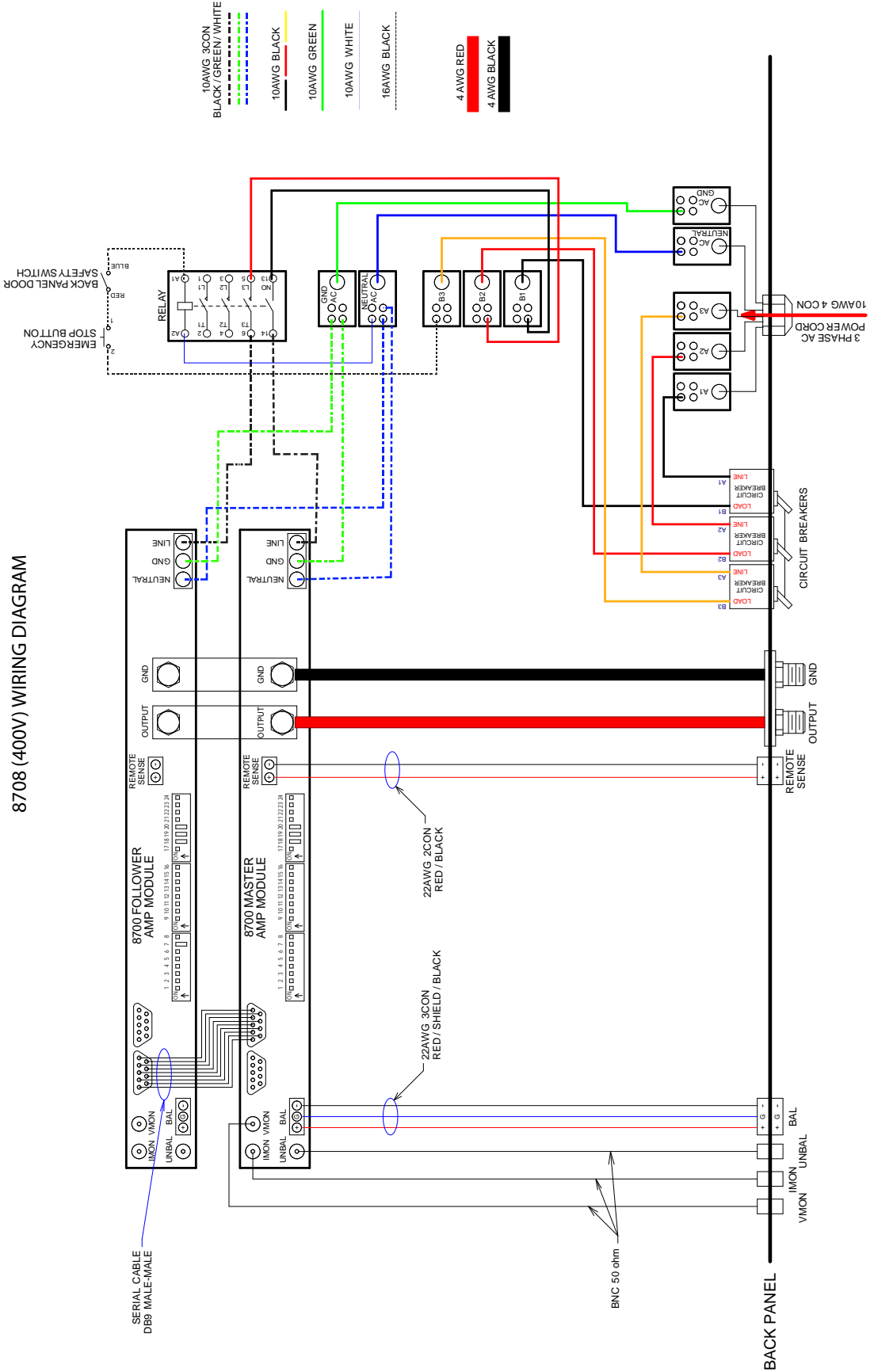

8712 (208V) WIRING DIAGRAM

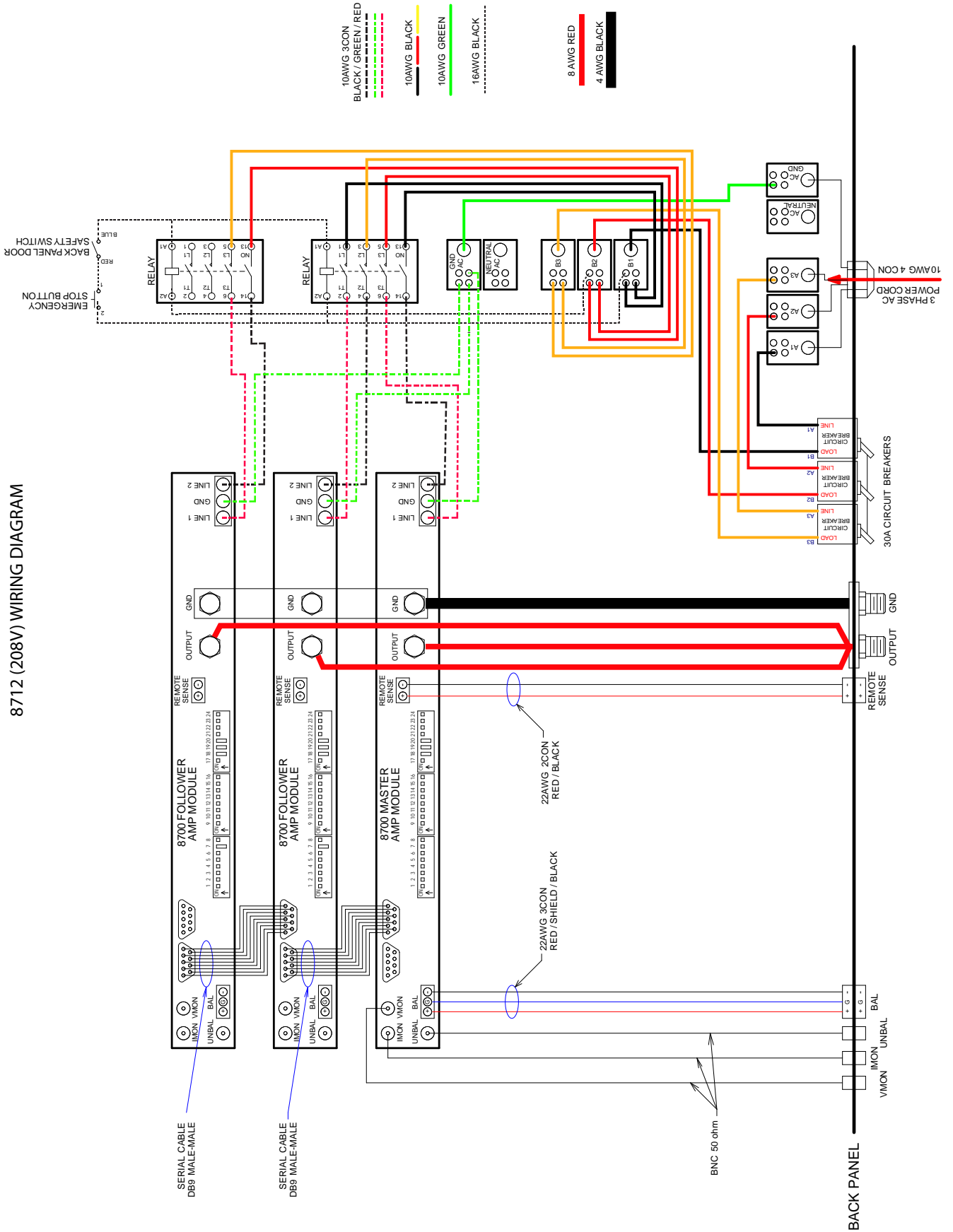

8712 (400V) WIRING DIAGRAM

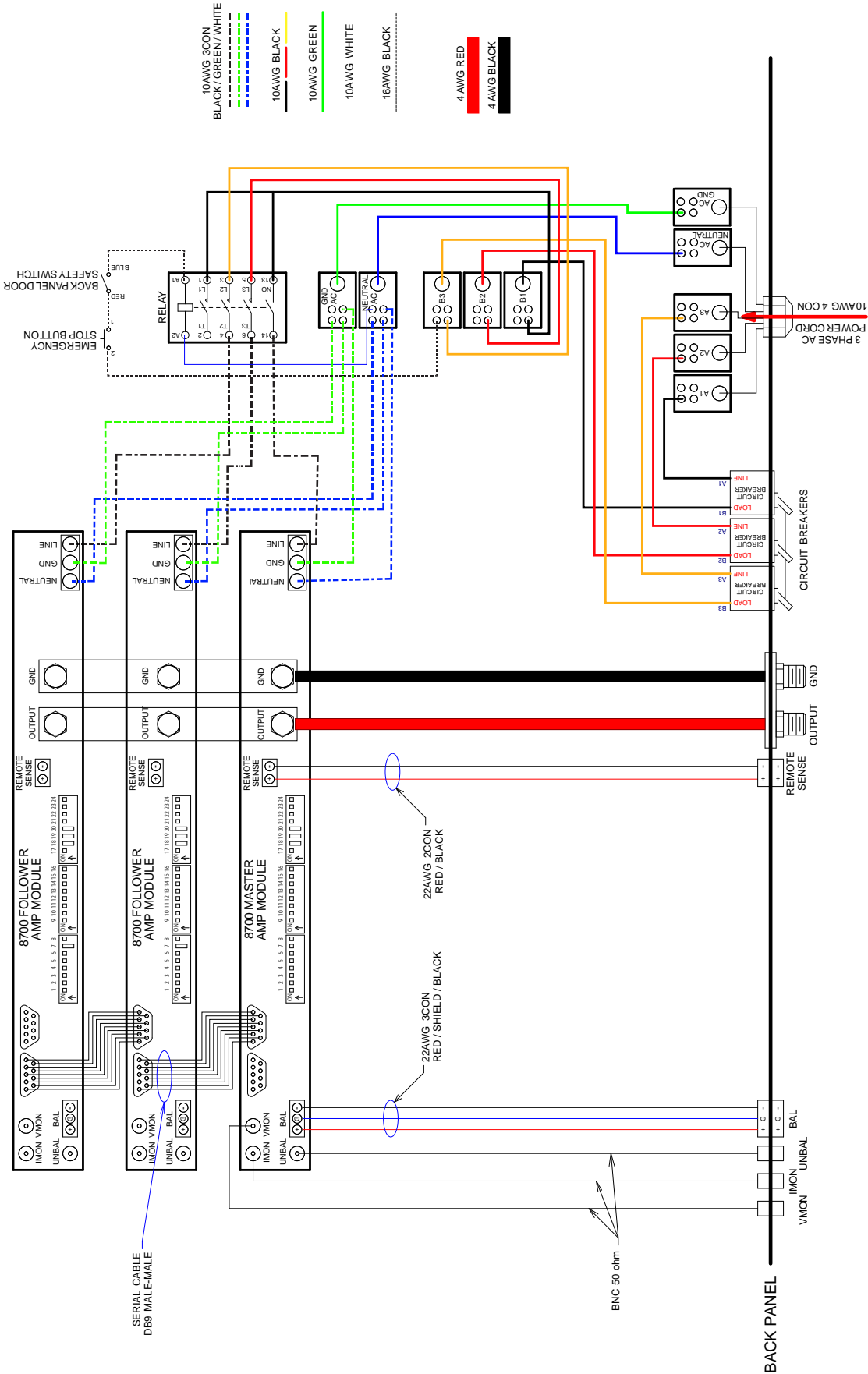

8716 (208V) WIRING DIAGRAM

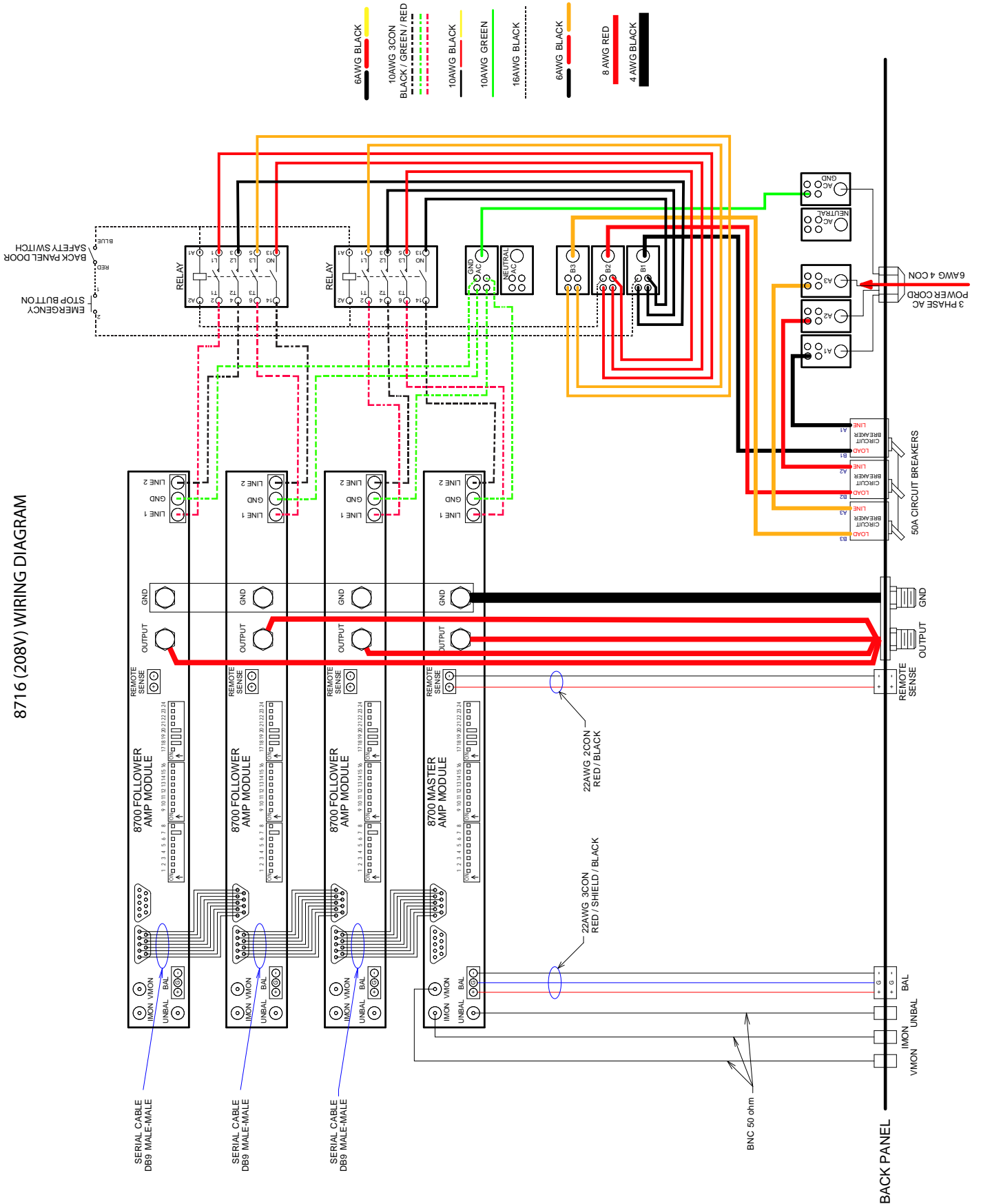

8716 (400V) WIRING DIAGRAM

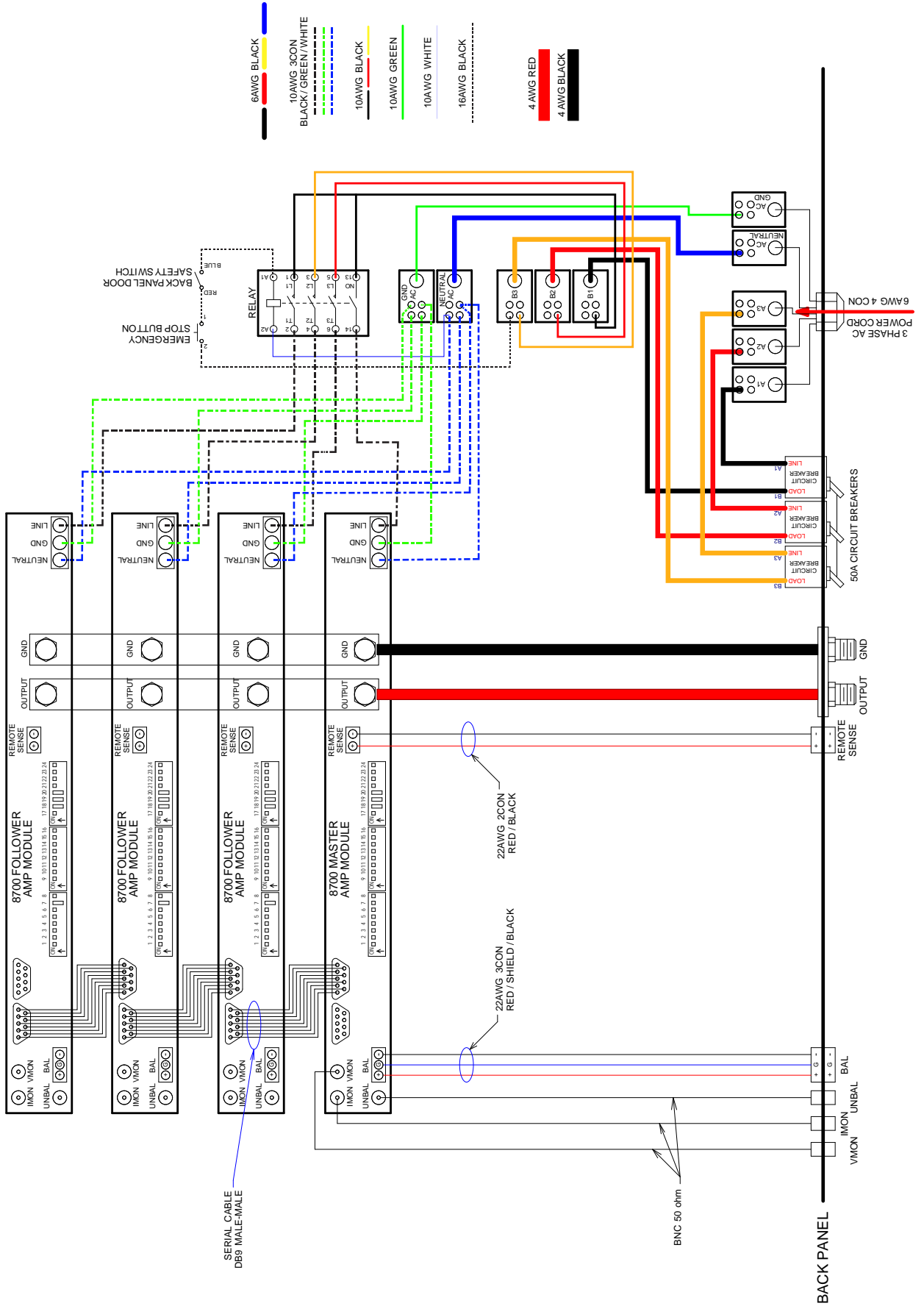

8720 (208V) WIRING DIAGRAM

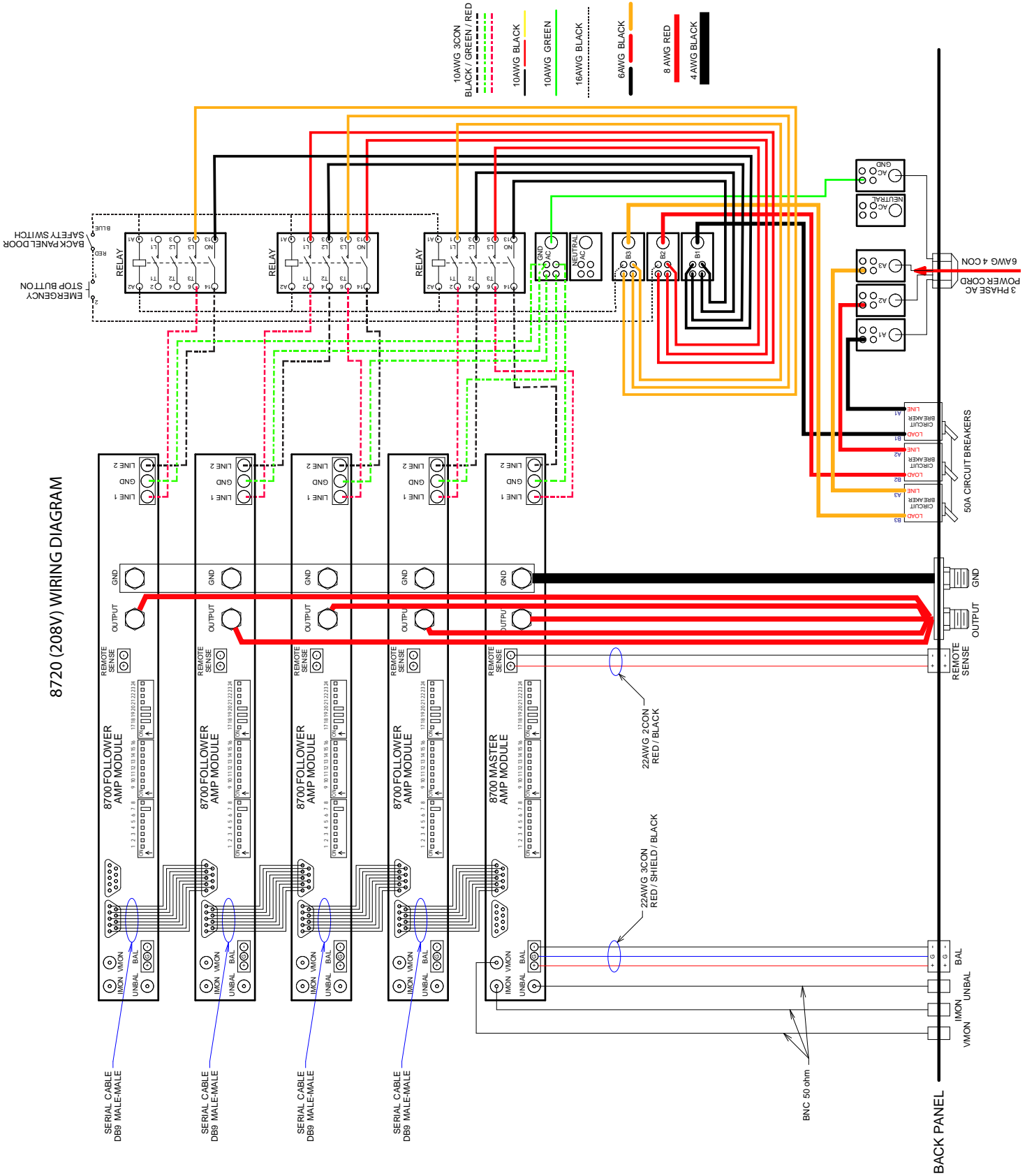

8720 (400V) WIRING DIAGRAM

