

AETECHRON



4301 Series

Power Amplifiers for GR-1089 Section 10 and ATIS-0600315.2007
DC Voltage Variations and Transients Testing

Operation Manual

Three-Year, No-Fault Warranty

SUMMARY OF WARRANTY

AE TECHRON INC., of Elkhart, Indiana (Warrantor) warrants to you, the ORIGINAL COMMERCIAL PURCHASER and ANY SUBSEQUENT OWNER of each NEW **AE TECHRON INC. product, for a period of three (3) years from the date of purchase, by the original purchaser (warranty period) that the product is free of defects in materials and workmanship and will meet or exceed all advertised specifications for such a product. We further warrant the new AE Techron product regardless of the reason for failure, except as excluded in the Warranty.**

ITEMS EXCLUDED FROM WARRANTY

This AE Techron Warranty is in effect only for failure of a new AE Techron product which occurred within the Warranty Period. It does not cover any product which has been damaged because of any intentional misuse, or loss which is covered under any of your insurance contracts. This warranty does not extend to any product on which the serial number has been defaced, altered, or removed. It does not cover damage to loads or any other products or accessories resulting from **AE TECHRON INC.** product failure. It does not cover defects or damage caused by the use of unauthorized modifications, accessories, parts, or service.

WHAT WE WILL DO

We will remedy any defect, regardless of the reason for failure (except as excluded), by repair or replacement, at our sole discretion. Warranty work can only be performed at our authorized service centers or at our factory.

Expenses in remedying the defect will be borne by **AE TECHRON INC.**, including one-way surface freight shipping costs within the United States. (Purchaser must bear the expense of shipping the product between any foreign country and the port of entry in the United States and all taxes, duties, and other customs fees for such foreign shipments.)

HOW TO OBTAIN WARRANTY SERVICE

When you notify us or one of our authorized service centers of your need for warranty service, you will receive an authorization to return the product for service. All components must be shipped in a factory pack or equivalent which, if needed, may be obtained

from us for a nominal charge. We will take corrective actions and return the product to you within three weeks of the date of receipt of the defective product, or will make available to you a product of equal or better performance on temporary loan until your product can be repaired or replaced and returned to you. If the repairs made by us are not satisfactory, notify us immediately.

DISCLAIMER OF CONSEQUENTIAL AND INCIDENTAL DAMAGES

You are not entitled to recover from us any consequential or incidental damages resulting from any defect in our product. This includes any damage to another product or products resulting from such a defect.

WARRANTY ALTERATIONS

No person has the authority to enlarge, amend, or modify this warranty. The warranty is not extended by the length of time for which you are deprived of the use of this product. Repairs and replacement parts provided under the terms of this warranty shall carry only the unexpired portion of this warranty.

DESIGN CHANGES

We reserve the right to change the design of any product from time to time without notice and with no obligation to make corresponding changes in products previously manufactured.

LEGAL REMEDIES OF PURCHASER

There is no warranty that extends beyond the terms hereof. This written warranty is given in lieu of any oral or implied warranties not contained herein. We disclaim all implied warranties, including, without limitation, any warranties of merchantability or fitness for a particular purpose. No action to enforce this Warranty shall be commenced later than ninety (90) days after expiration of the warranty period. This statement of warranty supersedes any others contained in this manual for AE Techron products.

AE TECHRON INC.

Customer Service Department

2507 Warren St. Elkhart, IN, 46516, U.S.A.
(574) 295-9495
www.aetechron.com

Contents

1	Introduction	5
1.1	About AE Techron	5
2	System Setup	6
2.1	Safety First	6
2.2	Unpacking and Installing	6
2.3	4301 Series Cabinet Location	6
2.4	Connections and Startup	8
3	Operation	11
3.1	Main Power Selector	11
3.2	Amplifier Compensation Panel	11
3.3	Amplifier Front Control Panel	11
3.4	Startup Sequence	14
4	Protective Device Operation Transient Testing	15
5	Maintenance	17
5.1	Clean Amplifier Filters and Grills	17
6	Troubleshooting	18
6.1	Visual Inspection	18
6.2	No LEDs Illuminated or No Fans	18
6.3	No Power to the Cabinet	18
6.4	Overload Fault Warning Message	19
6.5	Overvoltage Fault Warning Message	19
6.6	Standby LED Remains Illuminated	19
6.7	Over Temperature Fault Warning Message	19
6.8	Fault LED Remains Illuminated/Output Device Fault	19
6.9	Servicing your Unit	20

1 Introduction

Thank you for your decision to purchase the 4301 amplifier system. This product has been specially designed for EMC testing of network telecommunications equipment and is capable of producing the waveforms required for transient voltage measurements as described in GR-1089 Section 10 and ATIS-0600315.2007.

The 4301 includes a SDG2042X Function/Arbitrary Waveform Generator, which comes pre-programmed and integrated into the 4301 system. Together, the 4301 with Siglent AWG provide a complete solution for GR-1089 Section 10/ATIS-0600315.2007 testing.

The 4301 system is available in four standard configurations and is capable of slew rates of up to 60 V/ μ sec. In its largest configuration (model 4301-240), the 4301 system can provide up to 240A of DC at +50VDC or –50VDC and can provide pulses of up to 800 amps at voltages of up to \pm 100V. The system has a voltage gain of 20 and can accept input voltages of up to \pm 10V.

Lower power versions of the 4301 amplifier solution are available for users with lower current requirements: 4301-180 (180A), 4301-120 (120A) and 4301-60 (60A). For more information on these lower power versions, please contact your local AE Techron representative or AE Techron directly.

1.1 About AE Techron

AE Techron, Inc. is a recognized world leader in the design and manufacture of precision, audio-frequency power amplifiers and product safety

Features

- Complete solution for GR-1089 Section 10 and ATIS-0600315.2007 DC Voltage Variations and Transients Testing.
- Siglent SDG2024X AWG comes pre-programmed and integrated into the 4301 system.
- Slew rates up to 60 V/ μ sec.
- Up to 240A DC at +50VDC or –50VDC (4301-240 configuration).
- Can provide pulses of up to 800 amps at voltages of up to \pm 100V (4301-240 configuration).
- Adjustable compensation allows the system to maintain a 50V/2 μ sec rise-time over a wide range of current outputs.

compliance systems for the EMC marketplace. Their flagship 7224 linear amplifier features a DC-300 kHz bandwidth; it has been recognized by Ford for use in EMC-CS-2009 testing. Other products offer solutions for power susceptibility and conducted immunity testing found in Telecom (GR 1089 Section 10/ATIS-0600315.2007), Aviation (DO-160, MIL-STD-461), and Automotive (SAE J1113-22, ISO 16750-2, MIL-STD1275, GMW3172). With a focus on complete testing systems and configurable amplifier solutions for difficult requirements, AE Techron meets the challenges of the EMC industry by providing innovative design and exacting performance.

2 System Setup

2.1 Safety First

Throughout these instructions, special emphasis is placed on good safety practices. The following graphics are used to highlight certain topics that require extra precaution.

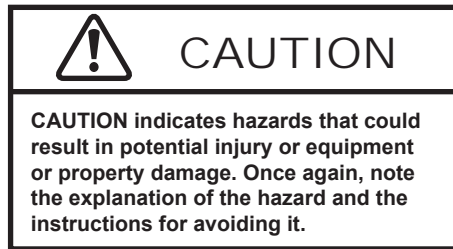
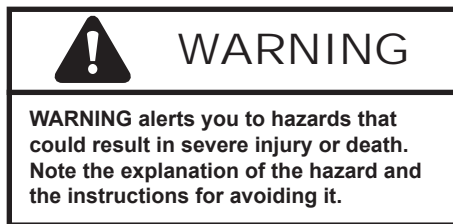
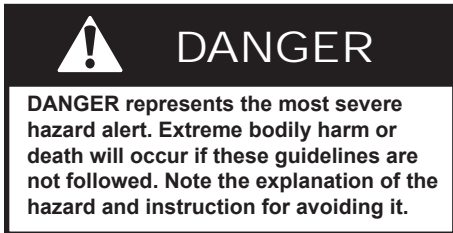

2.2 Unpacking and Installing

The 4301 will be delivered to the ship-to address enclosed in a wooden crate and transported on a special, shock-absorbing pallet. With the addition of packaging, the 4301-240 weights more than 850 pounds. To avoid serious injury and/or product damage, use a heavy-duty lift or other suitable equipment to unpack and move the product to its place of installation.

To uncrate the product, remove the crate's top, front, and back. Remove the accessories located

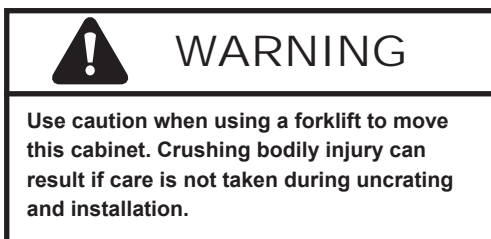

on the crate's shelf, then remove the shelf and packing material. Use a fork lift or other suitable equipment to glide the amplifier from the crate and off the pallet. Forklift provisions are provided in the base of the cabinet to facilitate this removal procedure (see **Figure 2.1**).



Figure 2.1 – Provisions in Cabinet Base for Forklifts

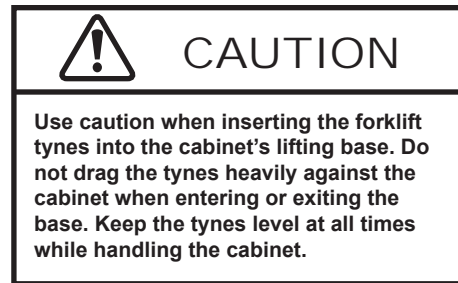

The cabinet has been tested and inspected for damage before leaving the factory. Carefully unpack and inspect the product for damage. **Please note any damage for future reference and notify the shipping company immediately if damage is found.** Also, please save the shipping crate and pallet as evidence of damage and/or for returning the cabinet for repair.

2.3 4301 Series Cabinet Location

4301 Series cabinets are mounted on wheels to allow rolling on a flat, smooth surface. The cabinet wheels should be used only for moving the cabinet over a short distance to position the cabinet in its permanent location. **DO NOT** use the cabinet

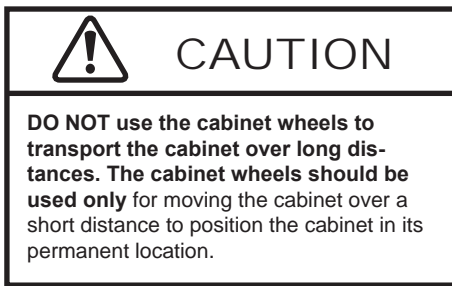

All of the wheels on the cabinet are equipped with a leveling pad that can be used to adjust the height of each wheel (see **Figure 2.3**). This leveling mechanism will also act to lock each wheel in place and prevent unintentional movement of the cabinet.

wheels to move the cabinet over long distances. To avoid possible tipping, always push the amplifier from the front and avoid rough or pitted surfaces.

Locate your cabinet near a three-phase power source. Allow enough clearance at the front and back of the cabinet to allow adequate airflow and hot air discharge through the cabinet rear. See **Figure 2.2** for clearance recommendations.



Figure 2.3 – Leveling pads on Cabinet Wheels

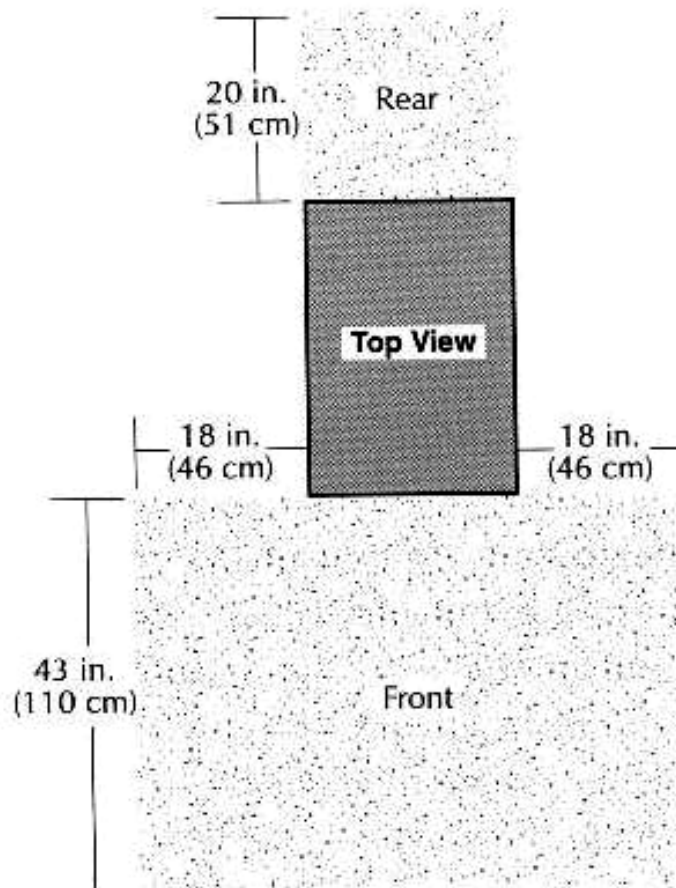

Figure 2.2 – Clearance Recommendations for Cabinet Placement

Two covers have been provided to insert into fork lifting openings at the front of the cabinet once the cabinet has been set in its final location.

2.4 Connections and Startup

This section details the wiring and startup procedures for a 4301 series amplifier. Before connecting the amplifier inputs and outputs, make sure the AC power is disconnected.

2.4.1 Connecting the Inputs

Use a standard BNC cable to connect from the Siglent AWG to the Signal Input BNC connector located on the cabinet front input/output panel (see **Figure 2.4**).

2.4.2 Connecting the Current and Voltage Monitors (optional)

BNC connectors for Current and Voltage monitoring are located on the cabinet front input/output panel (see **Figure 2.4**). Use a standard BNC cable to connect from the cabinet front-panel BNC connectors to your measuring device. For proper measurements, the measuring device should have an input impedance of at least 100 kOhms. **NOTE:** The current monitor output has been filtered and cannot properly display the fast transient waveforms.

Voltage Monitor:

4301-240: 10V output = 1V monitor output.

4301-180: 10V output = 1V monitor output.

4301-120: 10V output = 1V monitor output.

4301-60: 20V output = 1V monitor output.

Current Monitor:

4301-240: 80A output = 1V monitor output.

4301-180: 60A output = 1V monitor output.

4301-120: 40A output = 1V monitor output.

4301-60: 20A output = 1V monitor output.

2.4.3 Connecting the Signal Outputs

Preparation and Cautions

Before connecting the amplifier, make sure the AC power is disconnected.

Using the supplied 250A Pin-Plug connectors (or optional Anderson SB350 connectors), wire two cables to connect to the Equipment Under Test. Insert the wired connectors into the Output Signal connectors (see **Figure 2.4**).

2.4.4 Connect the Power Source

WARNING

ELECTRIC SHOCK HAZARD. Power supply wiring should only be performed by a qualified, licensed electrician.

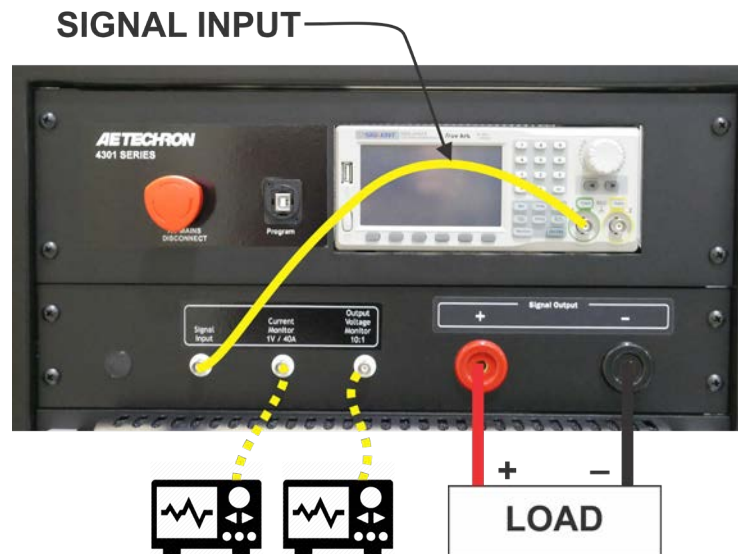

Figure 2.4 – 4301 Input and Output Connections

Disconnect and Inlet Wiring Protection

A safety disconnect device for the AC mains input must be installed so that it is both nearby and accessible to the operator. The disconnect must be clearly labeled.

Inlet wiring must support the rated current.

The amplifier must be protected by fuses or circuit breakers that protect the power inlet wiring with a maximum rating no more than the rated current for the product model.

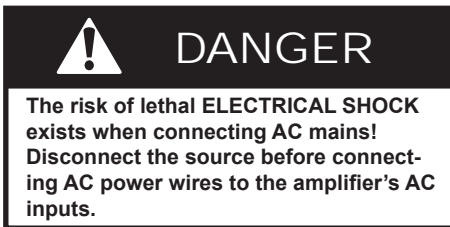

AC Inlet Connections

Always operate the amplifier from the proper AC mains. The 4301 series amplifier requires three-phase, 50-60 Hz, 208 VAC (or optional 400 VAC) with no more than 10% variance above or below the line voltage. The amplifier will not operate properly outside these limits.

All 4301 systems require 5-conductor wiring.

Supply a suitable gauge wiring depending on the system configuration: **4301-240:** 120A; **4301-180:** 90A; **4301-120:** 60A; and **4301-60:** 30A.

Connect protective grounding terminal to AC mains ground before turning on power to prevent electric shock hazard.

Do not disconnect or disable the protective grounding connection. Doing so causes a potential electrical shock hazard.

Complete the following steps to connect the amplifier to your three-phase power source:

1. Wear safety goggles.
2. Disconnect your AC power source.
3. Open the access door on the back of the amplifier and locate the fuse and AC inlet panel near the bottom of the amplifier. Locate the power block, which is mounted behind the fuse and AC inlet panel (see **Figure 2.5**).
4. Route the 10 AWG, 5 conductor power input cable into the amplifier through the cable strain relief (located on the fuse and AC inlet panel).
5. Connect to the AC mains barrier strip as shown in **Figure 2.5**.

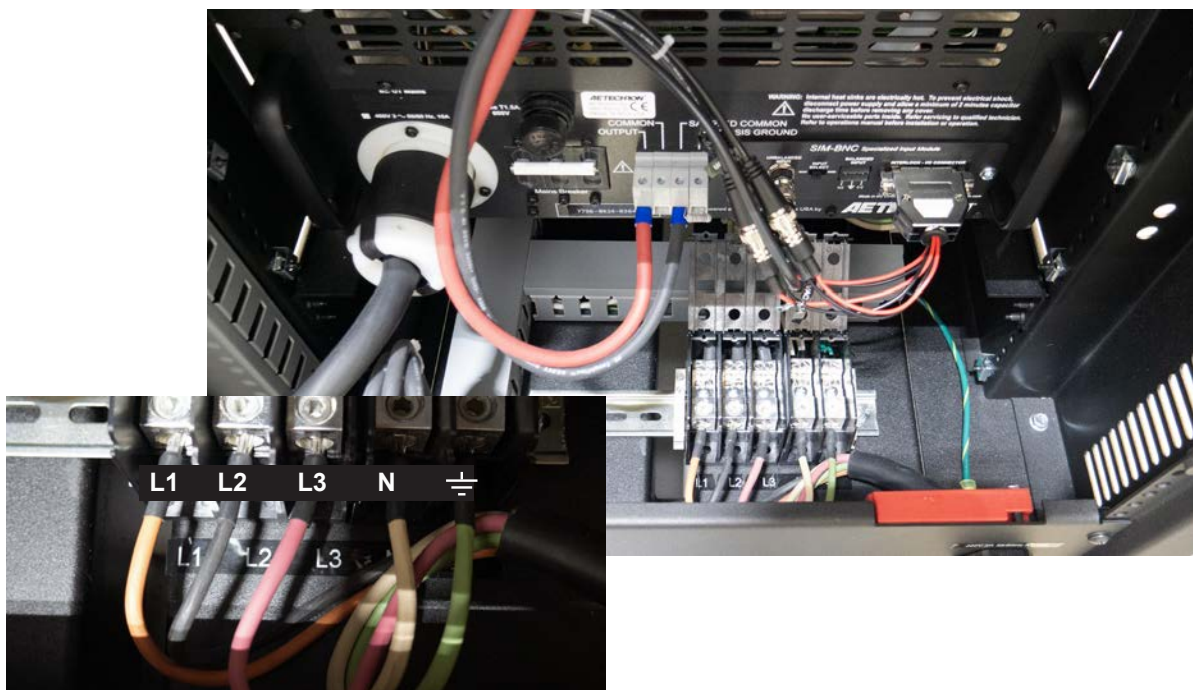

Figure 2.5 – Location of AC Mains Barrier Strip with labeling detail (inset)

6. If connecting to an AC power cord, verify connector wiring for phases, neutral and safety ground. Verify that proper phase, neutral and safety ground connections have been made at the AC mains breaker.
7. To power the system, make sure the breakers located at the bottom rear of the cabinet (next to the power supply inlet) are in the on (UP) position (see **Figure 2.6**). Then turn the front panel Main Power selector to the “ON” position (not depressed) to enable the main power supply



Figure 2.6 – AC Breakers

3 Operation

3.1 Main Power Selector

The cabinet Main Power Selector is located near the top of the cabinet on the cabinet front (see Figure 3.1). Turn the Main Power selector to the “ON” position (not depressed) to enable the main power supply. To disable the main power supply, press the Main Power selector to place it in the “OFF” (depressed) position.



Figure 3.1 – AC Mains Disconnect Switch

3.2 Amplifier Compensation Panel

The 4301 system is equipped with an adjustable compensation system, which allows the 4301 to maintain a 50V/2μS rise-time over a wide range of

current outputs. Select the optimum compensation setting based on the system model and the total current required at the system output (see Figure 3.2). **NOTE:** In general, adjust the peak voltage and DC offset of the input signal to achieve the required output waveform.

Depending on the model, your 4301 system will contain from one to four amplifier compensation control panels (see Figure 3.3). Each compensation control panel independently controls the compensation setting for that amplifier. **IMPORTANT:** For proper system operation, the compensation setting for all amplifiers in the system must be the same. When the amplifier is receiving AC power, the colored LED associated with the selected Compensation setting will be lit.

CAUTION

All amplifiers in the system must be set to the same compensation setting for proper system operation.

3.3 Amplifier Front Control Panel

The 4301 will contain from one to four front control panels, depending on the model. Each control

	Compensation Setting			
	0	1 (blue)	2 (green)	3 (red)
Model	Current Required			
4301-60	0-6A (compensation off)	6-12A	12-50A	50-60A
4301-120	0-12A (compensation off)	12-24A	24-100A	100-120A
4301-180	0-18A (compensation off)	18-36A	36-150A	150-180A
4301-240	0-24A (compensation off)	24-50A	50-200A	200-240A

Figure 3.2 – Selecting the Optimum Compensation Setting



Figure 3.3 – 4301 Compensation Control Panel

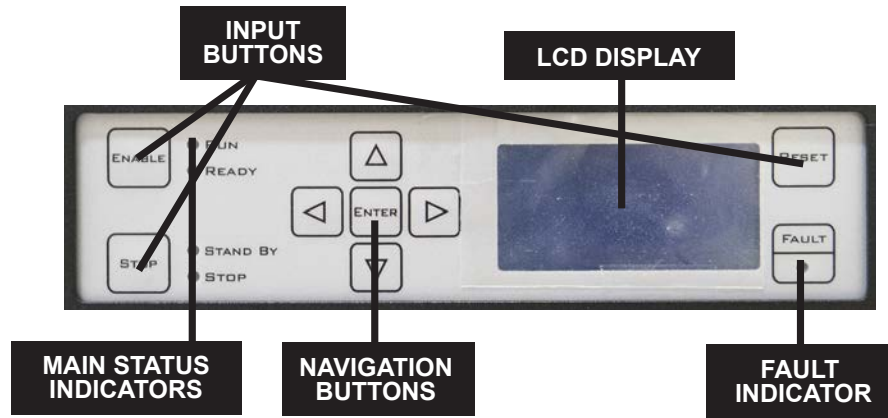

Figure 3.4 – 4301 Amplifier Front Panel Controls and Indicators

panel can be used independently to control one amplifier in the 4301 system. The controls and indicators include: multi-function LCD Display, Navigation buttons, Input buttons and LED Main Status and Fault indicators. See **Figure 3.4**.

3.3.1 LCD Display and Controls

The multi-function LCD Display provides peak and RMS values for voltage and current measured directly from the amplifier output. The LCD display also allows manual control of the bi-level power supply function. In addition, the LCD display gives details and prescribed corrective actions in the event of a fault condition.

Voltage and Current Displays

By default, the 4301 LCD display for each amplifier will default to the multi-display, showing values for peak and RMS voltage and peak and RMS current. If desired, the following optional Voltage and Current displays can be selected by pressing the Down arrow on the Navigation Buttons:

- | | |
|--------------------------|-------------------------|
| 1. V_{peak} / I_{peak} | 4. V_{RMS} / I_{peak} |
| 2. V_{RMS} / I_{RMS} | 5. I_{RMS} / I_{peak} |
| 3. I_{RMS} / V_{peak} | 6. V_{RMS} / V_{peak} |

Bi-Level Power Supply Setting

The Bi-Level Power Supply design used by the 4301 amplifiers allows each unit to switch automatically between high- and low- voltage modes based on the application requirements, or to switch from low- to high-voltage mode when triggered. By default, the 4301 will power up in Bi-Level Auto

mode, and all amplifiers in the system will automatically adjust their power-supply settings based on the application requirements. The Bi-Level Auto setting works well for most general-purpose uses when the application requirements are greater than 60 volts.

For purposes of ATIS testing, one of two “trigger” modes must be selected via the LCD Screen control panel for all amplifiers in the system. The Waiting for Manual Trigger mode must be selected for the system’s Leader amplifier, and the Waiting for Leader Trigger mode must be selected for the remaining Follower amplifiers in the system.

By default, the Leader amplifier of the system will be the amplifier placed in the uppermost position in the rack. The amplifier status as Leader or Follower is also indicated on the amplifier LCD screen during the power-up sequence. Note: The 4301-60 system contains only one amplifier (the Leader amplifier), so only the Waiting for Manual Trigger setting should be used for that system model.

To change to an alternate setting, wait until power-up is complete, and then use the arrow keys on the Navigation Buttons to scroll Down to the Bi-Level Auto screen. Use the Left and Right arrow keys to select the desired Bi-Level Setting. Available settings include:

1. **Bi-Level Auto:** Unit will automatically switch between low- and high-voltage modes according to the application requirements. Use this setting for continuous operation when the

application requirements are greater than 60 volts.

2. **Bi-Level High:** Used for diagnostic purposes. Do not select this mode unless directed by an AE Techron Service Technician.
3. **Bi-Level Low:** Used for diagnostic purposes. Do not select this mode unless directed by an AE Techron Service Technician.
4. **Waiting for Manual Trigger:** Select this setting for the Leader amplifier (or, for the 4301-60, the only amplifier) in the 4301 system when using the 4301 Trigger function, such as when performing ATIS testing. When in this mode, pressing the Enter button on the Leader amplifier will cause the Bi-Level Power Supply setting to switch automatically while a precise signal delay provides very fast, smooth slew rate. The 4301 Trigger function is recommended for all applications requiring a 25 V/ μ s or faster slew rate.
5. **Waiting for Leader Trigger** (selection available only on Follower amplifiers): Select this setting for all Follower amplifiers in the 4301 system when using the 4301 Trigger function, such as when performing ATIS testing. When in this mode, all Follower amplifiers will perform automatic power-supply switching when the trigger function is activated via a press of the Enter button on the Leader amplifier. The 4301 Trigger function is recommended for all applications requiring a 25 V/ μ s or faster slew rate.

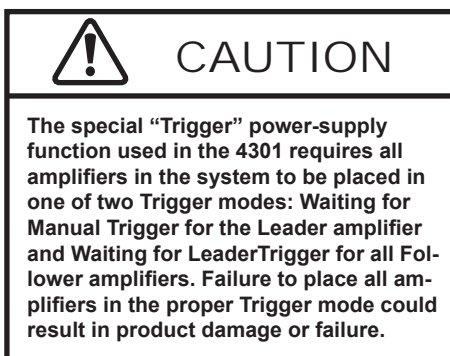

Navigation Buttons

The Navigation buttons provide four arrow keys to allow navigation through the various LCD display options.

3.3.2 Main Status Indicators

Four Main Status indicators, located on the front control panel for each amplifier, monitor and indicate the internal conditions of the amplifier.

Stop (red) and Standby (yellow) illuminated – When the Stop and Standby indicators are lit, the amplifier is in Stop Mode. When the Stop button on the amplifier front panel is pressed, the amplifier will enter Stop mode. The amplifier may also enter Stop mode after powering up if the amplifier is configured to enter Stop mode on startup. In Stop mode, the amplifier's low-voltage transformer is energized but the high-voltage transformers are not.

Standby (yellow) illuminated – When the Standby indicator is lit on one or more of the amplifiers, and one or more of the amplifiers has no LEDs lit, the unlit amplifier has no power or has not been turned on, and the other amplifiers in the system will be held in Standby mode. In Standby mode, the amplifier's low-voltage transformer is energized but the high-voltage transformers are not.

Ready (yellow) and Run (green) illuminated – When the Ready and Run indicators are lit, the amplifier is in Run mode. The amplifier's high-voltage transformers are energized and the unit will amplify the input signal. Run mode is initiated by: (1) the Enable push button, or (2) when the amplifier powers up in Run mode (factory default).

3.3.3 Fault Indicator

The Fault Indicator is a red LED located on the front control panel for each amplifier. When the Fault LED is blinking, it indicates that the amplifier's Bi-Level Power Supply has been set to operate in Bi-Level High mode.

When the Fault LED stays lit, it indicates that the amplifier was forced into Stop mode by a fault condition. The root cause of the fault condition and corrective actions are displayed on the LCD display.

The following list details the possible Fault conditions and the prescribed remedies:

- **Overload Fault** – An Overload fault condition is caused by amplifier output clipping. Lower the input signal and, if needed, press the Reset button to bring the unit out of the fault condition.
- **Over-Temperature Fault** – An Over-Temperature fault condition is caused by the output transistor heat sinks getting too hot. Allow the unit to cool, and the amplifier will automatically reset when the unit has cooled to operating temperature. If, after allowing the unit to cool, the unit does not reset, press the Reset button to bring the amplifier out of this fault condition.
- **Over-Voltage (high-line) Fault** – An Over-Voltage fault condition is caused by the three phase line supply voltage exceeding 110% of the rated line voltage. Reduce the input voltage and press the Reset button to bring the unit out of this fault condition.
- **Output Device Fault** – An Output Device fault condition is caused by an output transistor failing, unit or amplifier instability, undesired oscillation, or the fly back protection bridge is shorted. Factory service is usually required when this fault condition occurs.

3.3.4 Input Buttons

Three Input Buttons located on the front control panel for each amplifier control the operation mode of the unit.

- **Enable Button** – The Enable button moves the amplifier from Stop mode and into Run mode. To completely enable the 4301 system and allow the unit to amplify signal, the Enable buttons for each amplifier must be individually pushed.
- **Stop Button** – The Stop button forces the unit into the Stop mode. Pushing the Stop button for any amplifier will place the entire system in Stop mode. In this mode, power on two legs of the three phase mains input power is interrupted by internal solid state relays. To disconnect completely the AC Mains, use the Main Power selector.
- **Reset Button** – The Reset button brings the amplifier out of a Stop mode caused by a Fault condition. When all amplifiers displaying a Fault condition are reset, the 4301 system will move into Run mode.

3.4 Startup Sequence

3.4.1 System Power-up

Set the Main Power selector to the “ON” (not depressed) position to enable the main power supply. When Main Power is enabled, the unit will automatically begin the power-up sequence to activate the system. When the power-up sequence is complete for all amplifiers, the Stop and Standby LEDs will be lit for all amplifiers, and the LCD Screen will display the VPEAK / VRMS / IPEAK / IRMS meters (multi-display).

NOTE: As a safety precaution, this unit powers up in Stop mode. While in Stop mode, the unit will not amplify the input signal.

3.4.2 Enabling the System

To enable the system, press the Enable button on the front control panel for each amplifier. When all amplifiers are Enabled, the Run and Ready LEDs will be lit, and the amplifiers will amplify the input signal.

4 Protective Device Operation Transient Testing

The ATIS-0600315.2007 and GR-1089-CORE Standards require testing for protective device operation transient. This testing may be done using the waveform in Figure 1 of the Standard or using the three waveforms shown in Figures 2 through 4 of the Standard, each applied separately.

For those waveforms requiring a rise-time of 5 μ s or greater, the default Bi-Level Power Supply setting for the unit (Bi-Level Auto) should be used. However, for those waveforms requiring a rise-time of less than 5 μ s, the Trigger function and the two associated “Trigger” settings should be used. Complete the following procedure to perform the 4301 Trigger function.

TRIGGER FUNCTION PROCEDURE

1. **MAKE CONNECTIONS** (see Figure 4.1):
 - a. Connect the supplied BNC cable from the AWG’s first signal output connector (Output 1) to the 4301’s Signal Input connector.
 - b. Using the previously built output cables, connect from the Signal Output connectors to your load.
 - c. Connect your monitoring equipment to the 4301’s Current Monitor and Output Voltage Monitor connectors (optional).
2. **SELECT COMPENSATION SETTING:** Adjust the Compensation setting for each amplifier in the system based on the total required current output (see Figure 3.2). **CAUTION:** Compensation setting for all amplifiers in the system must be the same.
3. **POWER SYSTEM:** Set the Main Power selector to the “ON” (not depressed) position to enable the main power supply to the 4301 and allow each amplifier to enter Standby mode.
4. **SET TRIGGER MODES:** Using the Navigation arrow keys on the front control panel of each amplifier, set the Bi-Level Power Supply mode for each amplifier in the system. For the Leader amplifier, push the down arrow once, then push the left arrow once to set the amplifier to **Waiting for Manual Trigger**. Push the down arrow once, then push the left arrow twice to set the Bi-Level Power Supply mode for each Follower amplifier to **Waiting for Leader Trigger**. Note: The Waiting for Leader Trigger is not used on the 4301-60 system.
5. **SELECT WAVEFORM** (see Figure 4.2):
 - a. On the Siglent ARB’s front panel, press the Power button (if needed) to power on the unit.
 - b. Press the Store Recall button to access the unit’s File system.

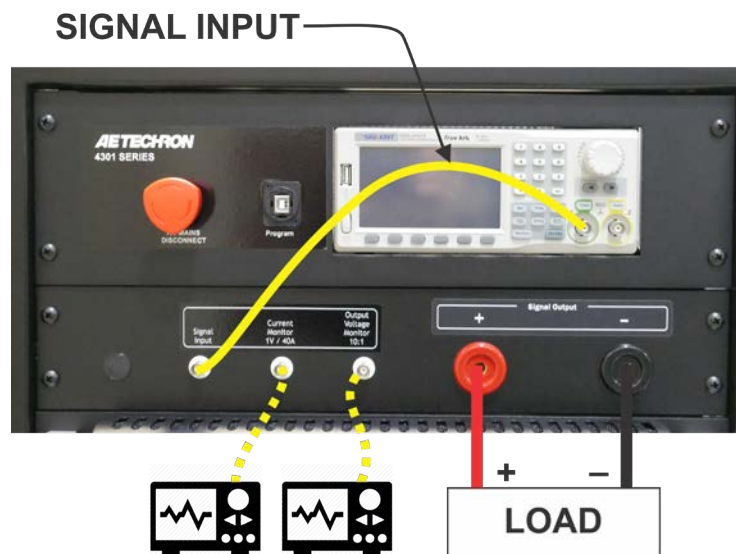

Figure 4.1 – 4301 Input and Output Connections

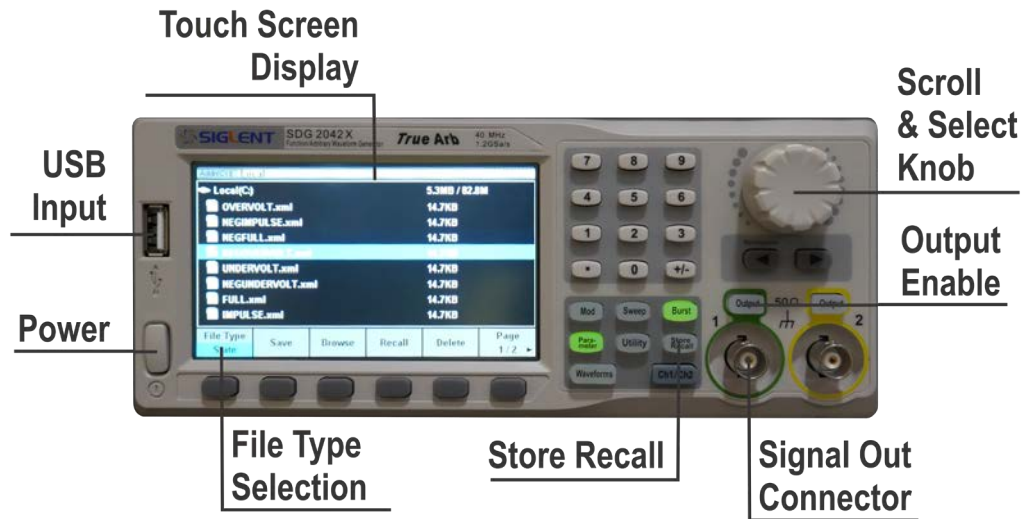

Figure 4.2 – Siglent Arb Display and Controls

- c. Locate the File Type Selection button at the bottom left of the ARB’s touch screen display. Press once to change the file type from “Data” (default) to “State.”
- d. Use the Scroll & Select knob to scroll through the preloaded waveform files. See **Figure 4.3** for a list of the waveform file names. Select your desired waveform, and then press the Scroll & Select knob to load the selected waveform.
- e. Press the Output Enable button (located above the ARB’s signal output connector) to activate the waveform.

Positive Waveforms	Negative Waveforms
Full	NegFull
Overvolt	NegOvervolt
Undervolt	NegUndervolt
Impulse	NegImpulse

Figure 4.3 – Transient Waveform File Names

- 6. **TRIGGER TRANSIENT TESTING:** To generate the transient waveform, push the Enable button on the Leader amplifier. The LCD Screen Display for the Leader amplifier will cycle through a 5-second countdown, output a 10 mS signal to the AWG through the External Trigger Output, and then trigger all amplifiers in the 4301 system to amplify and send the incoming input signal waveform (see **Figure 4.4**).
- 7. **VERIFY SUCCESSFUL TESTING:** After the input signal has been sent, the LCD screen for each amplifier will display “Triggered” to verify the successful completion of the test waveform (see **Figure 4.5**).



Figure 4.4 – Triggering Countdown



Figure 4.5 – Test Successfully Completed

IF DUT FAILS TEST: If the DUT fails using the full transient waveform, run the individual transient waveforms to determine the cause of failure.

5 Maintenance

Simple maintenance can be performed by the user to help keep the equipment operational. The following routine maintenance is designed to prevent problems before they occur. See the Troubleshooting section for recommendations for restoring the equipment to operation after an error condition has occurred.

Preventative maintenance is recommended after the first 250 hours of operation, and every three months or 250 hours thereafter. If the equipment environment is dirty or dusty, preventative maintenance should be performed more frequently.

The procedures outlined in this section are directed towards an experienced electronics technician; it assumes that the technician has knowledge of typical electronics safety and maintenance procedures.

5.1 Clean Amplifier Filters and Grills

5.1.1 Tools Required

The recommended equipment and supplies needed to perform the functions required for this task are described below.

- **Torx T15 driver**
- **Vacuum cleaner or compressed air blower**
- **Damp cloth (use water only or a mild soap diluted in water)**

To ensure adequate cooling and maximum efficiency of the internal cooling fans, the amplifier's front and rear grills should be cleaned periodically. To clean the amplifier grills and filter, complete the following steps:



1. Disconnect the system from its power source by turning the Main Power switch to the OFF position.
2. Remove the four Torx-head screws, located along the left and right edges of each amplifier's front panel using a Torx T15 driver. Retain.
3. Remove each amplifier's front cover by pulling straight towards you.
4. Using a vacuum cleaner, vacuum the front ventilation grills, including the filters behind each grill.
5. Using a damp cloth, clean the front ventilation grills. Dry with a clean cloth or allow to air dry.
6. Open the cabinet rear door and locate each amplifier's back panel grill.
7. Using a vacuum cleaner, vacuum the back ventilation grills.
8. Using damp cloth, clean the back ventilation grills.
9. Using a vacuum cleaner, remove any dust that has accumulated within the cabinet interior.
10. Close the cabinet rear door and reinstall amplifier front filters and ventilation grills. Secure the front grills using the retained screws
11. **IMPORTANT:** Grills and filters should be completely dry before restarting amplifier.

6 Troubleshooting

This section provides a set of procedures for identifying and correcting problems with the 4301. Rather than providing an exhaustive and detailed list of troubleshooting specifications, this section aims to provide a set of shortcuts intended to get an inoperative unit back in service as quickly as possible.

The procedures outlined in this section are directed towards an experienced electronic technician; it assumes that the technician has knowledge of typical electronics safety, repair and test procedures.

Please be aware that the 4301 undergoes frequent engineering updates. As a result, modules and electronic assemblies may not be interchangeable between units.

6.1 Visual Inspection

Before attempting to troubleshoot the 4301 while it is operating, please take time to complete a visual inspection of the internal components of the unit.

1. To perform a Visual Inspection, first turn “OFF” (depress) the power at the Main power selector and disconnect the unit from its power source.
2. Wait three to five minutes for the Power Supply capacitors to discharge.
3. Open the rear door of the cabinet and visually inspect all cables, wires and connectors. Note any frayed or burned wiring, loose connections or other physical signs of the source of faulty operation.

6.2 No LEDs Illuminated or No Fans

If one or more of the amplifier’s front Control Panels has no LEDs illuminated and the fans for any amplifier are inoperative, check the following:

1. Turn “OFF” (depress) the power at the Main power selector. Disconnect the unit from its power source.
2. Wait three to five minutes for the Power Supply capacitors to discharge.

3. Open the rear door of the cabinet by pulling the door handle up and then turning clockwise. Inspect the back-panel circuit breakers for each amplifier, as shown in **Figure 6.1**. Make sure each circuit breaker is in the UP position.
4. Locate the Fuse F1 Cover for each amplifier as shown in **Figure 6.1**.
5. For each amplifier, remove the Fuse Cover and Fuse F1. Inspect and replace the fuse if necessary.
6. Return Fuse F1 to its receptacle and replace the Fuse Cover.



Figure 6.1 – Location of Back-Panel Circuit Breakers and Fuse F1

6.3 No Power to the Cabinet

If all the amplifiers in the system have no power (front Control Panel LEDs are not illuminated and the fans are inoperative), and the Siglent waveform generator is also inoperative, check the following:

1. Turn “OFF” (depress) the power at the Main power selector. Disconnect the unit from its power source.
2. Locate the main power breaker switches located on the lowest back cabinet panel, as shown in **Figure 6.2**. If the circuit breaker is tripped, switch it to the ON position.
3. Reconnect the unit to the power source and turn the cabinet’s Main power switch to “ON” (not depressed).
4. If the cabinet circuit breakers continue to trip

during normal operation, contact AE Techron Technical Support.

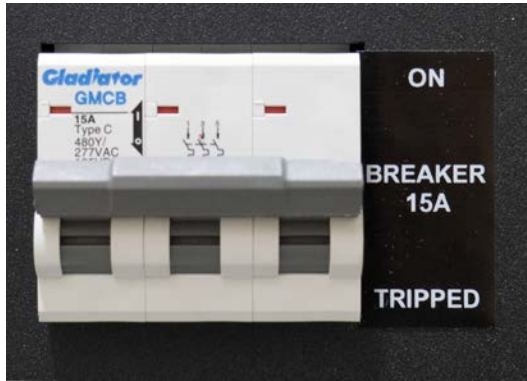

Figure 6.2 – Cabinet AC Breakers

6.4 Overload Fault Warning Message

An Overload fault condition is caused by amplifier output clipping. Lower the input signal and, if needed, press the Reset button to bring the unit out of the fault condition.

6.5 Overvoltage Fault Warning Message

The 4301 amplifiers will protect themselves from AC mains voltage that is 10% above the voltage specifications. If the AC mains voltage is more than 10% above the operating voltage, reduce the AC mains voltage to the proper level. Then press the Reset button to bring the amplifier out of this Fault condition.

6.6 Standby LED Remains Illuminated

The Standby indicator for any amplifier may remain illuminated if the output wells or power transformer for that amplifier have overheated. If overheating is the problem, see the following topic (“Over Temperature Fault Warning Message”).

6.7 Over Temperature Fault Warning Message

The overheating of any amplifier in the 4301 system may occur for two possible reasons:

1. Excessive Power Requirements
2. Inadequate Airflow

6.7.1 Excessive Power Requirements

An amplifier in the 4301 will overheat if the required power exceeds the component’s capabilities. High duty cycles and low-impedance loads are especially prone to cause overheating. To see if excess power requirements are causing overheating, check the following:

1. The application’s power requirements fall within the specifications of the product.
2. Faulty output connections and load.
3. Undesired DC offset at the Output and Input signal.

6.7.2 Inadequate Airflow

If the unit chronically overheats with suitable power/load conditions, then the unit may not be receiving adequate airflow. To check for adequate airflow, proceed with the following steps:

1. Check air filters for each amplifier. Over time they can become dirty and worn out. It is a good idea to clean the air filters periodically with a mild detergent and water.
2. Visually inspect fans for each amplifier to assure correct operation while unit is ON. Any inoperative, visibly slow, or reverse-spinning fan should be replaced.

An OverTemp condition places the unit in Standby mode. If the OverTemp pulse is extremely short, as in the case of defective wiring or switches, the OverTemp pulse may be too brief to observe.

6.7.3 Resetting After OverTemp

To reset the unit after an OverTemp has occurred, make sure fans are running, and then remove the input signal from the unit. Allow the fans to run for five minutes, and then push the Reset button for each amplifier to reset.

6.8 Fault LED Remains Illuminated/Output Device Fault

The 4301 amplifiers contain protection circuitry that disables the unit if an output stage is behaving abnormally. This usually indicates an output transistor has shorted.

To clear the Fault condition, follow these steps:

1. Turn off the signal source.
2. Turn off the Main Power selector.
3. Turn Main Power selector back on. If the Fault LED doesn't illuminate again, turn the signal source on.
4. If the Fault LED is still illuminated and the Fault condition doesn't clear, call Factory Service to determine the components requiring service.

6.9 Servicing your Unit

If the troubleshooting procedures are unsuccessful, one or more of the unit's components may need to be returned for Factory Service. Please contact AE Techron Technical Support at 1-574-294-9495 for help in determining the source of the Fault condition. This will help to avoid shipping unnecessary components back to the AE Techron Service Department.

All units under warranty will be serviced free of charge (customer is responsible for one-way ship-

ping charges as well as any custom fees, duties, and/or taxes). Please review the Warranty at the beginning of this manual for more information.

All service units must be given Return Authorization by AE Techron, Inc. before being returned. Return Authorizations can be requested on our website or by contacting our Customer Service Department.

Please take extra care when packaging your components for repair. Suitable packaging materials should be used and are available from AE Techron for a nominal fee.

Please send all service units to the following address and be sure to include your Return Authorization Number on the box.

AE Techron, Inc.

Attn: Service Department / RMA#

2507 Warren Street

Elkhart, IN 46516