

COM-TECH®

REFERENCE MANUAL

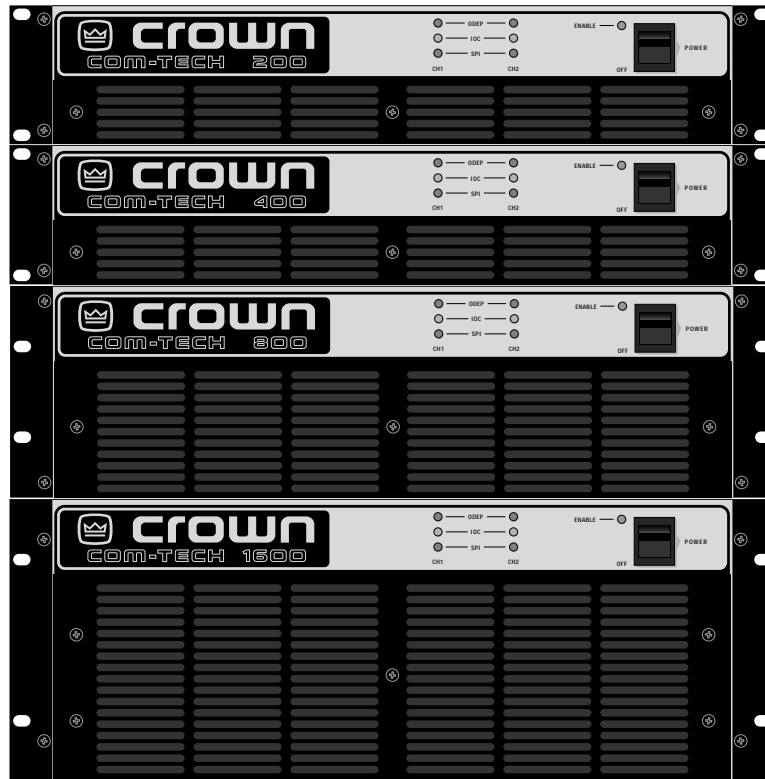

Models:

Com-Tech 200, 400, 800 & 1600

Some models may be exported under the name *Amcron*®.

Copyright ©1995 by Crown International, Inc., P.O. Box 1000, Elkhart, Indiana 46515-1000 U.S.A. Telephone: 219-294-8000. Com-Tech amplifiers are produced by the Professional Audio Division of Crown International, Inc. Trademark Notice: *SmartAmp*™, *MPX-6*™, *SMX-6*™, *AMB-5*™ and *Grounded bridge*™ are trademarks and *Amcron*®, *Crown*®, *Techron*®, *Com-Tech*®, *IOC*®, *ODEP*®, *IQ System*®, *P.I.P.*® and *TEF*® are registered trademarks of Crown International, Inc. Other trademarks are the property of their respective owners.

	<p>Approved for THX Theatre Systems (CT-400 & 800)</p>	<p>120 VAC North American Units:</p>		<p>Commercial Audio E106377</p>		<p>Fire Protective Signaling S5206</p>		<p>Commercial Audio LL 32521C</p>
--	--	--	--	-------------------------------------	--	--	--	---------------------------------------



THREE YEAR FULL WARRANTY



WORLDWIDE

SUMMARY OF WARRANTY

The Crown Audio Division of Crown International, Inc., 1718 West Mishawaka Road, Elkhart, Indiana 46517-4095 U.S.A. warrants to you, the ORIGINAL PURCHASER and ANY SUBSEQUENT OWNER of each NEW Crown¹ product, for a period of three (3) years from the date of purchase by the original purchaser (the "warranty period") that the new Crown product is free of defects in materials and workmanship, and we further warrant the new Crown product regardless of the reason for failure, except as excluded in this Crown Warranty.

¹ Note: If your unit bears the name "Amcron," please substitute it for the name "Crown" in this warranty.

ITEMS EXCLUDED FROM THIS CROWN WARRANTY

This Crown Warranty is in effect only for failure of a new Crown product which occurred within the Warranty Period. It does not cover any product which has been damaged because of any intentional misuse, accident, negligence, or loss which is covered under any of your insurance contracts. This Crown Warranty also does not extend to the new Crown product if the serial number has been defaced, altered, or removed.

WHAT THE WARRANTOR WILL DO

We will remedy any defect, regardless of the reason for failure (except as excluded), by repair, replacement, or refund. We may not elect refund unless you agree, or unless we are unable to provide replacement, and repair is not practical or cannot be timely made. If a refund is elected, then you must make the defective or malfunctioning product available to us free and clear of all liens or other encumbrances. The refund will be equal to the actual purchase price, not including interest, insurance, closing costs, and other finance charges less a reasonable depreciation on the product from the date of original purchase. Warranty work can only be performed at our authorized service centers. We will remedy the defect and ship the product from the service center within a reasonable time after receipt of the defective product at our authorized service center. All expenses in remedying the defect, including surface shipping costs to the nearest authorized service center, will be borne by us. (You must bear the expense of all taxes, duties and other customs fees when transporting the product.)

HOW TO OBTAIN WARRANTY SERVICE

You must notify us of your need for warranty service not later than ninety (90) days after expiration of the warranty period. All components must be shipped in a factory pack. Corrective action will be taken within a reasonable time of the date of receipt of the defective product by our authorized service center. If the repairs made by our authorized service center are not satisfactory, notify our authorized service center immediately.

DISCLAIMER OF CONSEQUENTIAL AND INCIDENTAL DAMAGES
YOU ARE NOT ENTITLED TO RECOVER FROM US ANY INCIDENTAL DAMAGES RESULTING FROM ANY DEFECT IN THE NEW CROWN PRODUCT. THIS INCLUDES ANY DAMAGE TO ANOTHER PRODUCT OR PRODUCTS RESULTING FROM SUCH A DEFECT.

WARRANTY ALTERATIONS

No person has the authority to enlarge, amend, or modify this Crown Warranty. This Crown Warranty is not extended by the length of time which you are deprived of the use of the new Crown product. Repairs and replacement parts provided under the terms of this Crown Warranty shall carry only the unexpired portion of this Crown Warranty.

DESIGN CHANGES

We reserve the right to change the design of any product from time to time without notice and with no obligation to make corresponding changes in products previously manufactured.

LEGAL REMEDIES OF PURCHASER

No action to enforce this Crown Warranty shall be commenced later than ninety (90) days after expiration of the warranty period.

THIS STATEMENT OF WARRANTY SUPERSEDES ANY OTHERS CONTAINED IN THIS MANUAL FOR CROWN PRODUCTS.

Telephone: 219-294-8200. Facsimile: 219-294-8301 9/90

NORTH AMERICA

SUMMARY OF WARRANTY

The Crown Audio Division of Crown International, Inc., 1718 West Mishawaka Road, Elkhart, Indiana 46517-4095 U.S.A. warrants to you, the ORIGINAL PURCHASER and ANY SUBSEQUENT OWNER of each NEW Crown product, for a period of three (3) years from the date of purchase by the original purchaser (the "warranty period") that the new Crown product is free of defects in materials and workmanship, and we further warrant the new Crown product regardless of the reason for failure, except as excluded in this Crown Warranty.

ITEMS EXCLUDED FROM THIS CROWN WARRANTY

This Crown Warranty is in effect only for failure of a new Crown product which occurred within the Warranty Period. It does not cover any product which has been damaged because of any intentional misuse, accident, negligence, or loss which is covered under any of your insurance contracts. This Crown Warranty also does not extend to the new Crown product if the serial number has been defaced, altered, or removed.

WHAT THE WARRANTOR WILL DO

We will remedy any defect, regardless of the reason for failure (except as excluded), by repair, replacement, or refund. We may not elect refund unless you agree, or unless we are unable to provide replacement, and repair is not practical or cannot be timely made. If a refund is elected, then you must make the defective or malfunctioning product available to us free and clear of all liens or other encumbrances. The refund will be equal to the actual purchase price, not including interest, insurance, closing costs, and other finance charges less a reasonable depreciation on the product from the date of original purchase. Warranty work can only be performed at our authorized service centers or at the factory. We will remedy the defect and ship the product from the service center or our factory within a reasonable time after receipt of the defective product at our authorized service center or our factory. All expenses in remedying the defect, including surface shipping costs in the United States, will be borne by us. (You must bear the expense of shipping the product between any foreign country and the port of entry in the United States and all taxes, duties, and other customs fees for such foreign shipments.)

HOW TO OBTAIN WARRANTY SERVICE

You must notify us of your need for warranty service not later than ninety (90) days after expiration of the warranty period. All components must be shipped in a factory pack, which, if needed, may be obtained from us free of charge. Corrective action will be taken within a reasonable time of the date of receipt of the defective product by us or our authorized service center. If the repairs made by us or our authorized service center are not satisfactory, notify us or our authorized service center immediately.

DISCLAIMER OF CONSEQUENTIAL AND INCIDENTAL DAMAGES
YOU ARE NOT ENTITLED TO RECOVER FROM US ANY INCIDENTAL DAMAGES RESULTING FROM ANY DEFECT IN THE NEW CROWN PRODUCT. THIS INCLUDES ANY DAMAGE TO ANOTHER PRODUCT OR PRODUCTS RESULTING FROM SUCH A DEFECT. **SOME STATES DO NOT ALLOW THE EXCLUSION OR LIMITATIONS OF INCIDENTAL OR CONSEQUENTIAL DAMAGES, SO THE ABOVE LIMITATION OR EXCLUSION MAY NOT APPLY TO YOU.**

WARRANTY ALTERATIONS

No person has the authority to enlarge, amend, or modify this Crown Warranty. This Crown Warranty is not extended by the length of time which you are deprived of the use of the new Crown product. Repairs and replacement parts provided under the terms of this Crown Warranty shall carry only the unexpired portion of this Crown Warranty.

DESIGN CHANGES

We reserve the right to change the design of any product from time to time without notice and with no obligation to make corresponding changes in products previously manufactured.

LEGAL REMEDIES OF PURCHASER

THIS CROWN WARRANTY GIVES YOU SPECIFIC LEGAL RIGHTS. YOU MAY ALSO HAVE OTHER RIGHTS WHICH VARY FROM STATE TO STATE. No action to enforce this Crown Warranty shall be commenced later than ninety (90) days after expiration of the warranty period.

THIS STATEMENT OF WARRANTY SUPERSEDES ANY OTHERS CONTAINED IN THIS MANUAL FOR CROWN PRODUCTS.

Telephone: 219-294-8200. Facsimile: 219-294-8301 9/90

The information furnished in this manual does not include all of the details of design, production, or variations of the equipment. Nor does it cover every possible situation which may arise during installation, operation or maintenance. If your unit bears the name "Amcron," please substitute it for the name "Crown" in this manual. If you need special assistance beyond the scope of this manual, please contact our Technical Support Group.

Crown Audio Division Technical Support Group

57620 C.R. 105, Elkhart, Indiana 46517 U.S.A.

Phone: 219-294-8200 Fax: 219-294-8301

Toll Free in Canada, Puerto Rico, the United

States & Virgin Islands: 1-800-342-6939

FIRE PROTECTIVE SIGNALING

THIS AMPLIFIER IS UL-LISTED FOR FIRE PROTECTIVE SIGNALING SYSTEMS.

REFER TO SECTION 9 FOR DETAILS

CAUTION

CLASS 1 OUTPUT WIRING REQUIRED.

CAUTION

**RISK OF ELECTRIC SHOCK
DO NOT OPEN**

TO PREVENT ELECTRIC SHOCK DO NOT REMOVE TOP OR BOTTOM COVERS. NO USER SERVICEABLE PARTS INSIDE. REFER SERVICING TO QUALIFIED SERVICE PERSONNEL. DISCONNECT POWER CORD BEFORE REMOVING REAR INPUT MODULE TO ACCESS GAIN SWITCH.

AVIS

**RISQUE DE CHOC ÉLECTRIQUE
N'OUVREZ PAS**

À PRÉVENIR LE CHOC ÉLECTRIQUE N'ENLEVEZ PAS LES COUVERCLES. RIEN DES PARTIES UTILES À L'INTÉRIEUR. DÉBRANCHER LA BORNE AVANT D'OUVRIR LA MODULE EN ARRIÈRE.



WARNING

TO REDUCE THE RISK OF ELECTRIC SHOCK, DO NOT EXPOSE THIS EQUIPMENT TO RAIN OR MOISTURE!

Magnetic Field

CAUTION! Do not locate sensitive high-gain equipment such as preamplifiers or tape decks directly above or below the unit. Because this amplifier has a high power density, it has a strong magnetic field which can induce hum into unshielded devices that are located nearby. The field is strongest just above and below the unit.

If an equipment rack is used, we recommend locating the amplifier(s) in the bottom of the rack and the preamplifier or other sensitive equipment at the top.

WATCH FOR THESE SYMBOLS:



The lightning bolt triangle is used to alert the user to the risk of electric shock.



The exclamation point triangle is used to alert the user to important operating or maintenance instructions.



Printed on recycled paper.

CONTENTS

1	Welcome	7
1.1	Unpacking	7
1.2	Features	7
2	Facilities	8
3	Installation	10
3.1	Mounting	10
3.2	Cooling	10
3.2.1	Cooling for Units without Internal Fans	11
3.2.2	Additional Cooling for Units with Internal Fans	11
3.3	Wiring	12
3.3.1	Mode of Operation	12
3.3.2	Input Connection	17
3.3.3	Output Connection	18
3.3.4	Additional Load Protection	20
3.4	AC Mains Power	21
4	Operation	22
4.1	Precautions	22
4.2	Indicators	22
4.3	Protection Systems	23
4.3.1	<i>ODEP</i>	23
4.3.2	Standby Mode	24
4.3.3	Transformer Thermal Protection	24
4.3.4	Circuit Breaker	24
4.4	Controls	25
4.5	Filter Cleaning	25
5	Technical Information	26
5.1	Overview	26
5.2	Circuit Theory	26
5.2.1	Dual Operation	26
5.2.2	Bridge-Mono Operation	28
5.2.3	Parallel-Mono Operation	28
6	Specifications	29
7	AC Power Draw and Thermal Dissipation	42
8	Accessories	44
8.1	<i>P.I.P.</i> Modules	44
8.2	Cooling Fan Option (120 VAC, 60 Hz only)	46
8.3	Constant Voltage Computer	46
9	Fire Protective Signaling	47
10	Service	48
10.1	Worldwide Service	48
10.2	North American Service	48
10.2.1	Service at a North American Service Center	48
10.2.2	Factory Service	48

ILLUSTRATIONS

1.1	Com-Tech Amplifiers (120 VAC, 60 Hz Units)	6
2.1	Front Facilities	8
2.2	Rear Facilities	9
3.1	Mounting Dimensions	10
3.2	Top View of a Rack-Mounted Unit	11
3.3	Extra Cooling with a Rack-Mounted Blower	12
3.4	Wiring for Dual 8/4 Ohm Mode	13
3.5	Wiring for Dual 70 Volt Mode	14
3.6	Wiring for Bridge-Mono 70 Volt Mode (140 Volt Output)	15
3.7	Wiring for Parallel-Mono 70 Volt, Bridge-Mono 8/4 Ohm and Parallel-Mono 8/4 Ohm Modes	16
3.8	Unbalanced Input Wiring	17
3.9	Balanced Input Wiring	17
3.10	Subsonic Filter Capacitor Values	17
3.11	Unbalanced RFI Filters	18
3.12	Balanced RFI Filters	18
3.13	Wire Size Nomograph	19
3.14	Inductive Load (Transformer) Network	20
3.15	Loudspeaker Fuse Nomograph	20
4.1	ODEP, IOC and Signal Presence Indicator States	23
4.2	Input Sensitivity Switch	25
5.1	Circuit Block Diagram	27
6.1	Com-Tech 200 Minimum Power Matrix	32
6.2	Com-Tech 400 Minimum Power Matrix	33
6.3	Com-Tech 800 Minimum Power Matrix	34
6.4	Com-Tech 1600 Minimum Power Matrix	35
6.5	Com-Tech 200 Maximum Power Matrix	36
6.6	Com-Tech 400 Maximum Power Matrix	37
6.7	Com-Tech 800 Maximum Power Matrix	38
6.8	Com-Tech 1600 Maximum Power Matrix	39
6.9	Typical Frequency Response	40
6.10	Typical Damping Factor	40
6.11	Typical Output Impedance	40
6.12	Typical Phase Response	41
6.13	Typical Crosstalk	41
7.1	Com-Tech 200 Power Draw, Current Draw and Thermal Dissipation at Various Duty Cycles	42
7.2	Com-Tech 400 Power Draw, Current Draw and Thermal Dissipation at Various Duty Cycles	43
7.3	Com-Tech 800 Power Draw, Current Draw and Thermal Dissipation at Various Duty Cycles	43
7.4	Com-Tech 1600 Power Draw, Current Draw and Thermal Dissipation at Various Duty Cycles	43
8.1	Installing a P.I.P. Module	44
8.2	Cooling Fan Option	46
8.3	Cooling Fan Assembly	46

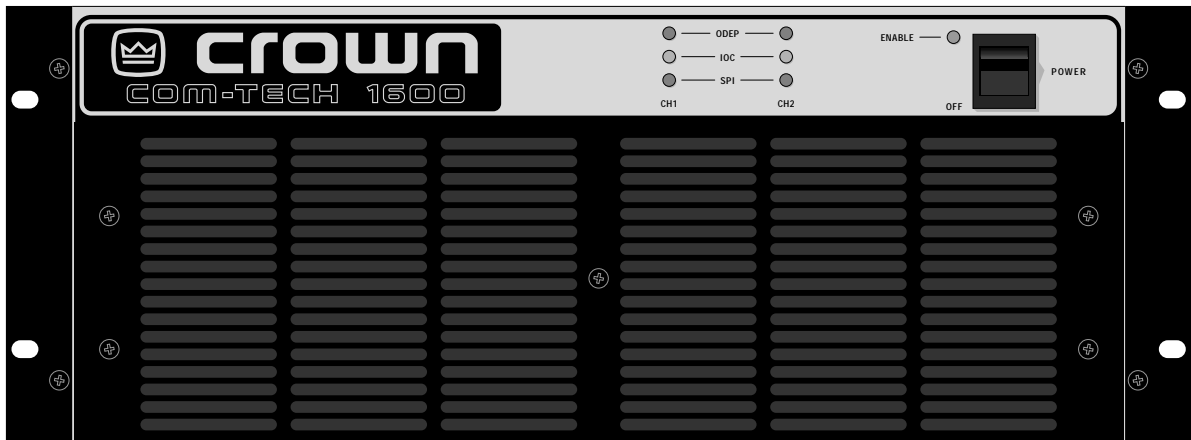
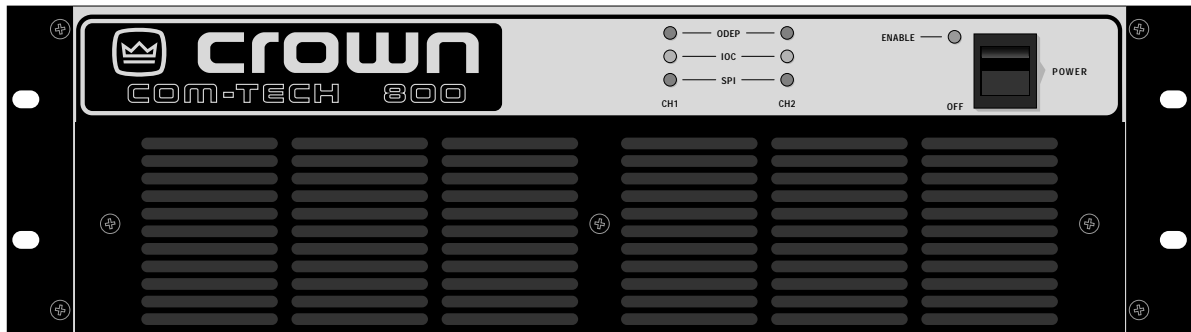
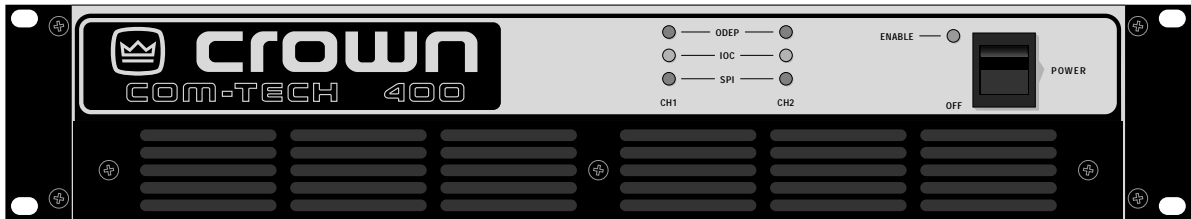
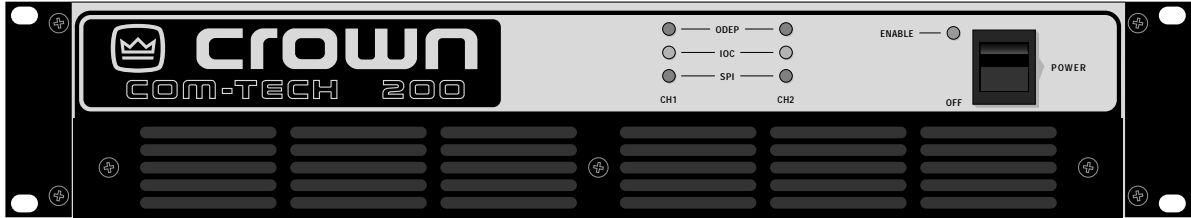
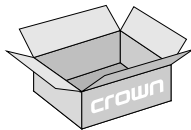

Fig. 1.1 Com-Tech Amplifiers (120 VAC, 60 Hz Units)

1 Welcome

Congratulations on your purchase of a *Com-Tech*® commercial power amplifier. The *Com-Tech* series is a complete family of amplifiers with a wide range of power output capabilities. *Com-Tech* amplifiers can directly drive “constant voltage” lines, so you can avoid the expense, distortion and insertion loss associated with step-up transformers for distributed loudspeaker systems. *Com-Tech* amplifiers also utilize Crown’s patented *ODEP*® protection circuitry which *keeps the amplifier working* under severe conditions that would shut down a lesser amplifier. All *Com-Tech* amplifiers feature Crown’s exclusive *P.I.P.*® (Programmable Input Processor) expansion system. The *P.I.P.* expansion system makes it easy to tailor your amplifier to a specific application or to add future technology as it develops (see Section 8 for a list of available *P.I.P.s*).

This manual will help you successfully install and use your new *Com-Tech* amplifier. Please read all instructions, warnings and cautions. Be sure to read Section 3.3.1 if you plan to use the amplifier in one of its two mono modes, or if you plan to drive “constant voltage” lines. Also for your protection, please send in your warranty registration card today and save your bill of sale as it is your **official proof of purchase**.



1.1 Unpacking

Please unpack and inspect your new amplifier for any damage that may have occurred during transit. If damage is found, notify the transportation company immediately. Only you, the consignee, may initiate a claim for shipping damage. Crown will be happy to cooperate fully as needed. Save the shipping carton as evidence of damage for the shipper’s inspection.

Even if the unit arrived in perfect condition, as most do, save all packing materials so you will have them if you ever need to transport the unit. **NEVER SHIP THE UNIT WITHOUT THE FACTORY PACK.**

1.2 Features

Com-Tech amplifiers use cutting edge technology and miniaturized design to provide the highest power and value for its size, weight and price. They offer numerous advantages over conventional designs and provide benefits you can’t get in amplifiers from any other manufacturer. For example, Crown’s patented *ODEP*

protection circuitry *and grounded bridge*™ output stages combine to provide performance and reliability that surpass the other more traditional designs. Here are some more of your amplifier’s impressive features:

- ❑ Crown’s patented *ODEP*® (Output Device Emulation Protection) circuitry detects and compensates for overheating and overload to keep the amplifier working when others would fail.
- ❑ Crown’s *grounded bridge*™ design delivers incredible voltage swings without using stressful output transistor configurations like conventional amplifiers. The results are lower distortion and superior reliability.
- ❑ *IOC*® (Input/Output Comparator) circuitry immediately alerts you if any type of distortion exceeds 0.05%. We provide this feature so you will have real-time *proof of distortion-free performance*.
- ❑ *P.I.P.* (Programmable Input Processor) connector accepts accessories that tailor the amplifier to suit specific applications.
- ❑ Drives constant voltage lines without “lossy,” distortion-producing step-up transformers.
- ❑ Two mono modes (Bridge-Mono and Parallel-Mono) for driving a wide range of load impedances.
- ❑ Very low harmonic and intermodulation distortion give the best *dynamic transfer function* in the industry.
- ❑ Superior damping factor delivers maximum loudspeaker motion control for a clean, accurate low end.
- ❑ Superb crosstalk characteristics and a separate voltage supply for each channel make it possible to treat each channel like a separate amplifier.
- ❑ Full protection from shorted, open and mismatched loads, general overheating, DC and high-frequency overloads. Full internal fault protection.
- ❑ Efficient heat sinks and three-speed fan dissipate heat quickly and evenly for extra amplifier protection and extended component life. (The fan is an option for 120 VAC, 60 Hz *Com-Tech 200s*.)
- ❑ Barrier blocks are provided for input and output connections.
- ❑ Internal three-position input sensitivity switch provides settings of 0.775 volts for full standard 1 kHz 8/4 ohm power, 0.775 volts for full standard 1 kHz 70 volt power, and 26 dB voltage gain.
- ❑ Mounts in a standard 19 inch (48.3 cm) equipment rack (units can also be stacked).
- ❑ Three year “No-Fault” full warranty completely protects your investment and guarantees its specifications.

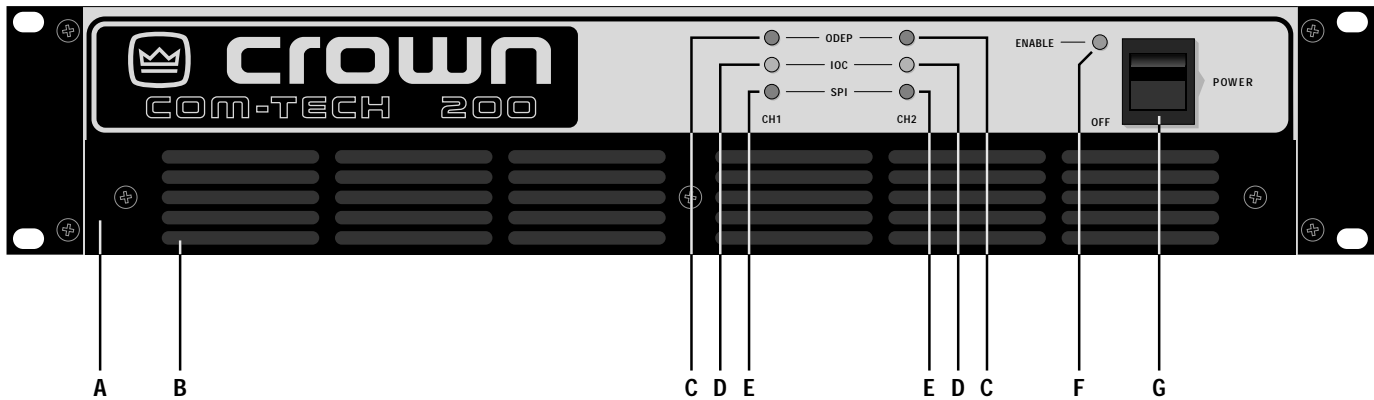

Fig. 2.1 Front Facilities

2 Facilities

A. Filter Grille

A metal grille supports and protects the dust filter (B). To clean the dust filter, detach the grille by removing the screws that fasten it in place.

B. Dust Filter

The dust filter removes large particles from air drawn by the cooling fan. (The fan is an option for 120 VAC, 60 Hz *Com-Tech 200s*.) Check the filter regularly to prevent clogging (see Section 4.5).

C. ODEP Indicators

During normal operation of the Output Device Emulation Protection circuitry, these green indicators glow brightly to show the presence of reserve thermal-dynamic energy. They dim proportionally as energy reserves decrease. In the rare event that energy reserves are depleted, the indicators turn off and *ODEP* proportionally limits output drive so the amplifier can safely continue operating even under severe conditions. These indicators can also help to identify more unusual operating problems (see Section 4.2).

D. IOC Indicators

The yellow *IOC* (Input/Output Comparator) indicators serve as sensitive distortion indicators to provide *proof of distortion-free performance*. Under normal conditions, the indicators remain off. They light up if the output waveform differs from the input by 0.05% or more (see Section 4.2). *Note: The channel 2 IOC indicator will stay on in Parallel-Mono mode.*

E. Signal Presence Indicators (SPI)

The signal presence indicators flash synchronously with the amplifier's audio output (see Section 4.2).

F. Enable Indicator

This indicator lights when the amplifier has been "enabled" or turned on, and AC power is available (see Section 4.2).

G. Enable Switch

This rocker switch is used to turn the amplifier on and off. When turned on, the output is muted for about four seconds to protect your system from turn-on transients. Delay times vary slightly from one unit to the next, so there is always a certain amount of "randomness" in the turn-on timing of multiple units. In addition, turn-on occurs at zero crossing of the AC waveform, so *Com-Tech* amplifiers rarely need a power sequencer. (To change the turn-on delay time, contact Crown's Technical Support Group.) See Section 4.4.

H. Power Cord

All 120 VAC, 60 Hz North American units have a NEMA 5-15P plug with an integral voltage presence lamp. These units include a 16 gauge power cord with *Com-Tech 200s* and *400s*, and a 14 gauge cord with *Com-Tech 800s* and *1600s*. Other units have an appropriate power cord and plug for the required AC voltage. Refer to Section 7 for more information on power usage.

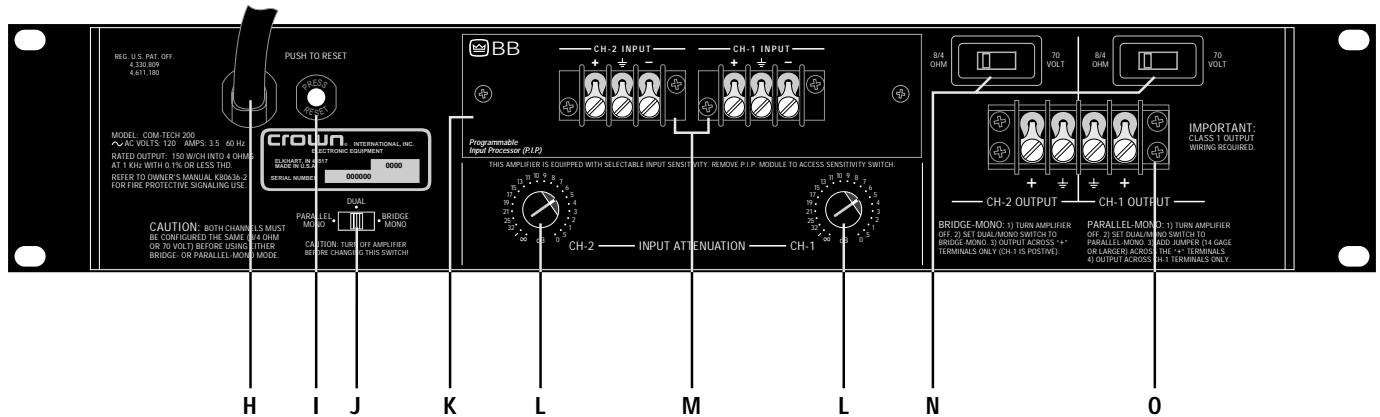

Fig. 2.2 Rear Facilities

I. Reset Switch

This reset switch is used to reset the circuit breaker that protects the power supplies from overload (see Sections 4.3.4 and 4.4).

J. Dual/Mono Switch

Slide this switch to the center for Dual (two-channel) mode, to the left for Parallel-Mono mode or to the right for Bridge-Mono mode. **WARNING: Do not change this switch unless the amplifier is turned off. Do not attempt to use the Bridge-Mono or Parallel-Mono modes unless both output mode switches (N) are set the same.** Also, be sure to follow the installation requirements for each mode (see Section 3.3.1).

K. P.I.P. Module

The standard *P.I.P.-BB* is included with your amplifier. It provides barrier block input connectors. Other *P.I.P.* modules can be used in place of the *P.I.P.-BB* to provide additional features that customize the amplifier for different applications (see Section 8 for available *P.I.P.* modules).

□ Input Sensitivity Switch

The three position input sensitivity switch located inside the amplifier is accessed by removing the *P.I.P.* module. It is set at the factory to 0.775 volts for standard 1 kHz power into 8 ohms. It can also be set to 0.775 volts for standard 1 kHz output in 70 volt mode, or a standard voltage gain of 26 dB (see Section 4.4).

L. Level Controls

Each channel's output level can be adjusted accurately using the 22 position detented level controls on the back panel. A Lexan cover is also included that can be used to prevent tampering (see Section 4.4).

M. Balanced Barrier Block Inputs

The *P.I.P.-BB* is included in the standard configuration. It provides a balanced barrier block with three terminals for each input channel. (XLR connectors are also available—see Section 8.1.)

N. Output Mode Switches

The output mode switches are used to configure each channel independently for either 8/4 ohm loads or 70 volt ("constant voltage") lines. **WARNING: Do not change these switches unless the amplifier is off. Do not attempt to use the Bridge-Mono or Parallel-Mono modes unless these switches are set the same.** Also, be sure to follow the special installation requirements for each mode (see Section 3.3.1).

O. Output Barrier Block

A barrier block with four terminals is provided for output connection. Output wiring will vary depending on the selected dual/mono mode and whether 70 volt output will be used (see Section 3.3.1).



3 Installation

This section covers basic *Com-Tech* installation procedures. If your amplifier will be used in a Fire Protective Signaling application, refer to Section 9 as well.

3.1 Mounting

Com-Tech amplifiers are designed for standard 19 inch (48.3 cm) rack mounting or stacking without a cabinet. In a rack, it is best to mount units directly on top of each other. This provides the most efficient air flow and support. If the rack will be transported, we recommend that you fasten the amplifier's back panel securely to the rack to help support the unit's weight.

All *Com-Tech* amplifiers are 19 inches (48.3 cm) wide, 16 inches (40.6 cm) deep, and 0.25 inches (0.6 cm) in front of the mounting surface. As you can see in Figure 3.1, *Com-Tech* amplifiers vary in their vertical dimensions. Figure 3.1 labels the different heights as A, B and C. These letters correspond to the list that follows showing *Com-Tech* models and their vertical dimensions.

- Height A: 3.5 inches (8.9 cm)
- Models: Com-Tech 200 (All)
- Com-Tech 400 (North American)

- Height B: 5.25 inches (13.3 cm)
- Models: Com-Tech 400 (100/120 VAC, 50/60 Hz)
- Com-Tech 400 (220/240 VAC, 50/60 Hz)
- Com-Tech 800 (All)

- Height C: 7 inches (17.8 cm)
- Model: Com-Tech 1600 (All)

3.2 Cooling

It is important to understand cooling considerations when installing a *Com-Tech* amplifier. First, never block the amplifier's front or side air vents. This can cause poor air flow and may result in overheating. If the amplifier is rack-mounted, its sides should be at least 2 inches (5 cm) away from the cabinet (see Figure 3.2). Also, open spaces in the front of the rack should be covered with blank panels to prevent improper air flow. Otherwise, heated air from the side exhaust vents can be drawn into the front air intake which may greatly reduce the cooling system's effectiveness.

The real air flow requirement for a *Com-Tech* amplifier depends on many things, but the most important factor is average (RMS) output power. Air flow requirements increase as output power increases, so anything that

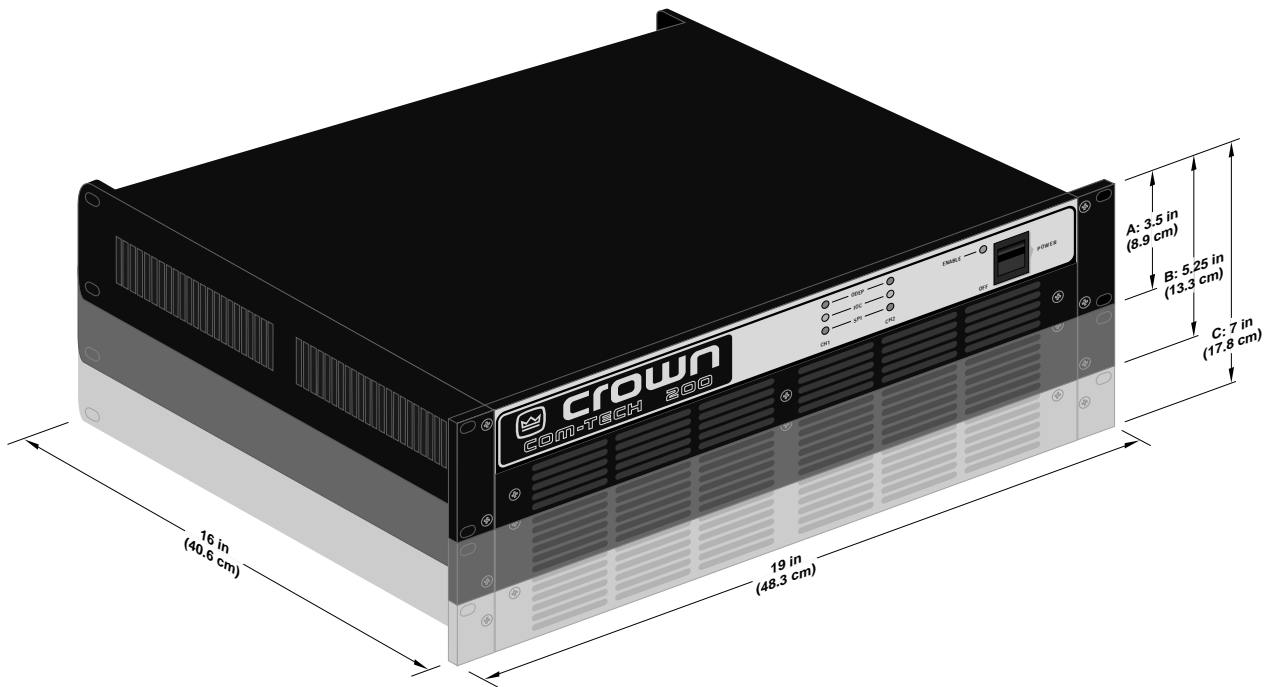

Fig. 3.1 Mounting Dimensions

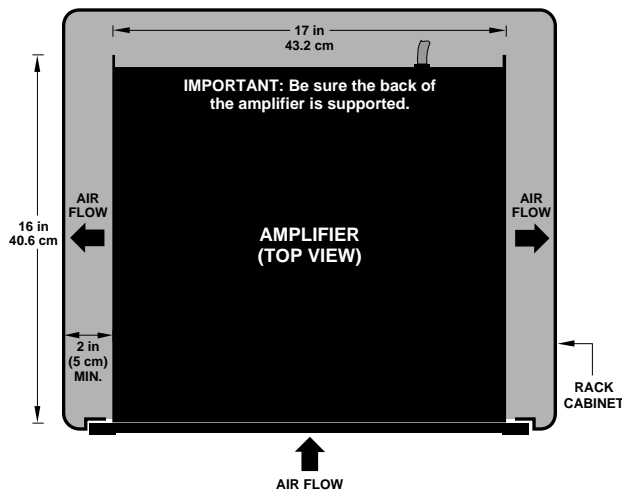

Fig. 3.2 Top View of a Rack-Mounted Unit

affects output power also affects the required air flow.

Average output power is mainly affected by three things: (1) duty cycle of the input signal, (2) load impedance, and (3) rated output power. First, as the duty cycle of the input signal increases, the average output power level increases. For example, the amplifier will need more air flow with a rock 'n' roll input signal than with infrequent paging. Second, as the load impedance of a connected loudspeaker gets smaller, more current will flow across the load which effectively increases output power. This means you can expect the amplifier to require more air flow with a 2 ohm load than with a 4 ohm load. Finally, an amplifier that is rated for higher power output is usually used at higher average output levels. So a *Com-Tech 1600* delivering full output will require more air flow than a *Com-Tech 200*. These relationships and the resulting thermal dissipation levels are defined mathematically in Section 7.

3.2.1 Cooling for Units without Internal Fans

All units have a three-speed on-demand cooling fan except for the North American *Com-Tech 200*. Forced-air cooling may not be needed for applications with a low duty cycle such as paging or background music. This is why the North American *Com-Tech 200* is usually provided without a fan.

If you will be using a North American *Com-Tech 200* in a high temperature environment, or at full power for sustained periods, you can anticipate that additional cooling will be needed. It may also be helpful to use the information in Section 7 to estimate the amplifier's thermal dissipation for your application. In general, a North American *Com-Tech 200* that dissipates more

than 400 btu (100 kcal) per hour per unit will need additional cooling. If you want to test your amplifier for sufficient cooling in the real world, an easy way is to observe the *ODEP* indicators while the amplifier is operating under worst-case conditions. If the indicators dim, additional cooling is recommended.

There are at least three ways to provide extra cooling for an amplifier that does not have an internal fan. The most effective method is to install an internal fan which is available from Crown as an accessory (see Section 8.2). If you know in advance that an internal fan is needed, you can order the *Com-Tech 200BF* which includes a factory-installed fan.

A rack-mounted blower or an air conditioner can also be used to provide extra cooling. In some situations, you may find it practical to use these methods without installing a fan in each amplifier. However, we generally recommend that you use the internal fans because they provide the most efficient cooling, and are active only when needed. Amplifiers that already have internal fans can also take advantage of a rack-mounted blower or air conditioner, so these approaches will be discussed in the section that follows.

3.2.2 Additional Cooling for Units with Internal Fans

If multiple amplifiers will be operated under demanding conditions (such as driving loads less than 4 ohms), or if air flow through the rack will be restricted, you should verify that the total air flow through the rack will be sufficient. As described in Section 3.2.1, sufficient air flow can be tested in the real world by observing the *ODEP* indicators while operating under worst-case conditions. If the indicators dim, cooling can be improved by reducing air restrictions, installing a rack-mounted blower, or using an air conditioner.

Many things can cause air flow restrictions, including improper mounting, bunched up power cords, closed rack doors, and clogged dust filters. A *Com-Tech* amplifier should be mounted in a way that allows sufficient air flow into the front intakes, out the side exhaust vents, and out the back of the rack. If your rack has a front door, it is usually best to leave it open and avoid blocking the air intakes. If this is impossible, supplement the air flow by mounting a grille in the door or with a rack-mounted blower. If you install a grille in the door, we recommend wire grilles over perforated panels because wire tends to cause less air restriction (perforated panels cause a minimum air restriction of 40%).

A better choice for increasing the air flow behind a rack cabinet door is to use a "squirrel cage" blower.

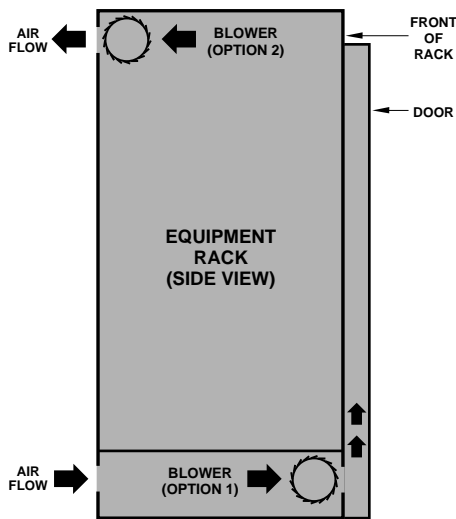

Fig. 3.3 Extra Cooling with a Rack-Mounted Blower

Mount the blower at the bottom of the rack so it blows outside air into the space between the door and the front of the amplifiers, pressurizing the “chimney” behind the door (Figure 3.3, Option 1). The blower should not blow air into or take air out of the space behind the amplifiers. For racks without a front door, you can evacuate the rack by mounting the blower at the top of the rack, so that air blows out the back (Figure 3.3, Option 2).

You can estimate the required air flow for a rack by adding together the maximum required air flow ratings of the individual units. The internal fan in a *Com-Tech 200* (if installed), *400* and *800* can move up to 35 cubic feet (1 cubic meter) of air per minute, while the internal fan in a *Com-Tech 1600* can move up to 65 cubic feet (1.8 cubic meters) per minute. If you mounted one of each *Com-Tech* model in a rack, worst-case conditions would require 170 cubic feet (4.7 cubic meters) of air flow through the rack every minute (3 x 35 cubic feet + 65 cubic feet = 170 cubic feet).

Air flow restrictions may also result if the air filter becomes clogged. If the air supply is unusually dusty, you can help prevent rapid loading of the unit’s air filter by pre-filtering the air using commercial furnace filters. And when needed, the unit’s filter can be cleaned with mild dish detergent and water (see Section 4.5).

The final method for increased cooling is to use air conditioning. Air conditioning is rarely a necessity because internal fans and rack-mounted blowers almost always provide enough air flow for even the most extreme conditions. Still, air conditioning can help by re-

ducing the temperature of the air circulated through the rack. If you intend to install air conditioning for your amplifiers, you may want to use Section 7 to determine the hourly thermal dissipation of your system.

3.3 Wiring

Figures 3.4 through 3.7 show common ways to install a *Com-Tech* amplifier in a sound system. Input and output terminals are located on the back panel. Please use care when making connections, selecting signal sources and controlling the output level. The load you save may be your own! Crown assumes no liability for damaged loads resulting from careless amplifier use or deliberate overpowering.



CAUTION: Always disconnect the AC power and turn the level controls off when making or breaking connections. This is very important when loudspeakers are connected because it reduces the chance of loud blasts that can cause loudspeaker damage.

3.3.1 Mode of Operation

Proper wiring depends on how you configure your amplifier. First, each output channel can be independently configured to drive step-down transformers in a distributed “constant voltage” loudspeaker system (70 volt mode) or loudspeakers that do not have step-down transformers (8/4 ohm mode). Second, the amplifier can be configured for Dual, Bridge-Mono or Parallel-Mono modes. Various combinations of these modes are possible, so be sure to note any special wiring requirements for the mode you will be using.



70 VOLT

The 70 volt output mode is used to drive constant voltage lines without expensive step-up transformers. Avoiding the use of step-up transformers not only saves money, but it also eliminates the distortion and insertion loss caused by this type of transformer.

Setting up 70 volt mode is easy. Turn off the amplifier, then slide the recessed output mode switches to the right (as you face the back panel).

If Bridge-Mono mode is used with 70 volt output, the amplifier will actually deliver 140 volts (more information is provided later in this section). To effectively use this mode, you may need to cross-reference power ratings for the step-down transformer taps using Crown’s constant voltage computer (see Section 8.3).



WARNING: The output mode switches must be set the same (8/4 ohm or 70 volt mode) when operating in Bridge-Mono or Parallel-Mono mode.

When connecting a 70 volt step-down transformer, do not exceed its power rating. Too much power can saturate a transformer and cause it to appear as a short circuit to the amplifier. If this happens, no damage should occur, but the amplifier may run less efficiently.



8 / 4 O H M

8/4 ohm mode is commonly used to drive loudspeakers with impedances from 2 to 16 ohms. When using this output mode, appropriate load impedances will depend on the dual/mono mode that you select. The available dual/mono modes (Dual, Bridge-Mono and Parallel-Mono) will be described in sections that follow.

Configuring your amplifier for 8/4 ohm mode is straightforward. Turn off the amplifier, then slide the output mode switches to the left (as you face the back panel).

When the amplifier is set up for two-channel (Dual mode) operation, it is possible to configure one output channel for 8/4 ohm operation and the other for 70 volt operation. If you plan to use different output modes like

this, the input sensitivity should be set to 0.775 volts for 70 volt output (see Section 4.4). Again, you must always configure both channels the same when using Bridge-Mono or Parallel-Mono modes.

Because of the way *Com-Tech* amplifiers are designed, they can actually be used to directly drive constant voltage lines in 8/4 ohm mode. Being able to use lower constant voltage levels can be very convenient if building codes or other obstacles do not permit higher constant voltage levels. When 8/4 ohm mode is used to drive a distributed loudspeaker system, the constant voltage output varies with the output power rating of the amplifier. With 8/4 ohm output in Dual or Parallel-Mono mode, the *Com-Tech 200* can drive a 25 volt line, the *Com-Tech 400* can drive a 35 volt line, the *Com-Tech 800* can drive a 50 volt line, and the *Com-Tech 1600* can drive a 70 volt line. Using Bridge-Mono mode, these voltage levels are doubled for a single channel. Again, to effectively use different constant voltage levels, you may need to cross-reference the ratings for the step-down transformers' taps using Crown's constant voltage computer (see Section 8.3).

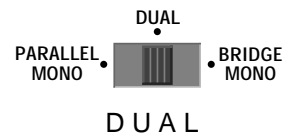

D U A L

Dual mode lets each amplifier channel work independently like a "dual mono" or stereo amplifier. And if you select both Dual mode and 70 volt output, each output

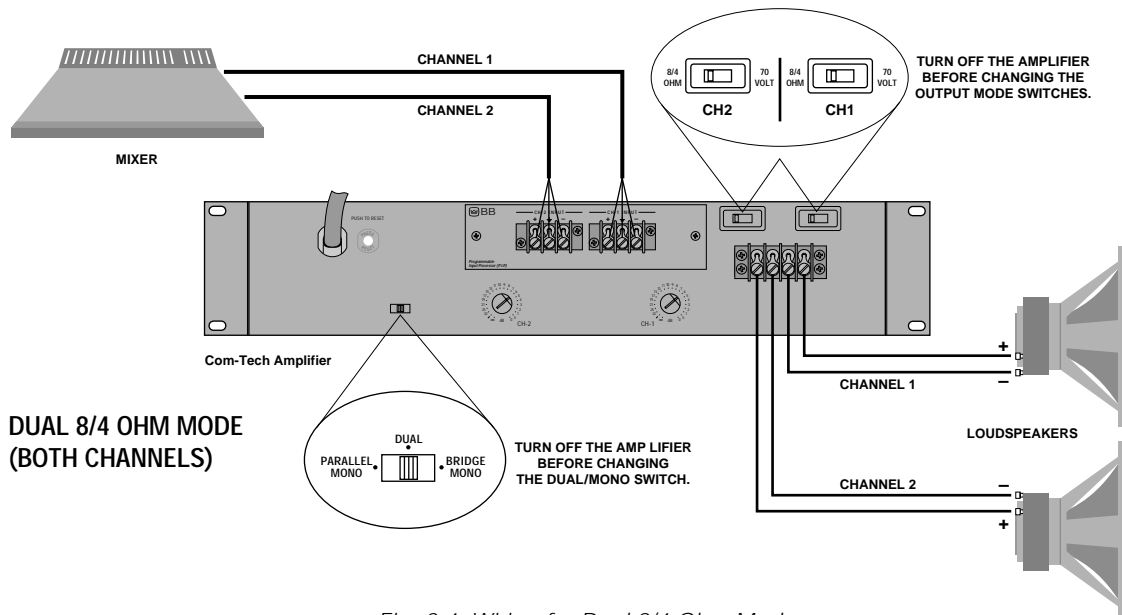

Fig. 3.4 Wiring for Dual 8/4 Ohm Mode

channel can be used to drive a 70 volt line. Installation is intuitive: input channel 1 feeds output channel 1, and input channel 2 feeds output channel 2.

! To put the amplifier into Dual mode, turn it off, slide the dual/mono switch to the center position, and properly connect the output wiring. Be sure to observe correct loudspeaker polarity (see Figure 3.4) and be careful not to short the two outputs.

CAUTION: Never tie an amplifier's outputs together directly, and never parallel them with the output of another amplifier. Such connections do not result in increased output power, but may cause overheating and premature activation of the protection circuitry.

Note: To parallel multiple amplifiers for fail-safe redundancy, contact Crown's Technical Support Group.



BRIDGE-MONO

Bridge-Mono mode is used to drive loads with a total impedance of at least 4 ohms (see *Parallel-Mono* if the load is less than 4 ohms). If Bridge-Mono mode and 70 volt output are used together, twice the normal output voltage is produced from a single channel to drive

140 volt distributed loudspeaker systems. If you will be using 140 volt output, you may need to cross-reference the ratings of the step-down transformer taps with Crown's constant voltage computer (see Section 8.3). If you need a single channel with higher power to drive a 70 volt line, use Parallel-Mono mode.



WARNING: Both channels must be configured for the same output mode (8/4 ohm or 70 volt) before switching to Bridge-Mono mode.

Bridge-Mono wiring is very different from the other modes and requires special attention. First, turn the amplifier off. Then select Bridge-Mono mode by sliding the dual/mono switch to the right (as you face the back panel). Both outputs will receive the signal from channel 1 with the output of channel 2 inverted so it can be bridged with the channel 1 output. **DO NOT USE THE CHANNEL 2 INPUT** or the signal level and quality may be greatly degraded. Also, keep the channel 2 level control turned down completely (counterclockwise).

Note: The channel 2 input jack and level control are not defeated in Bridge-Mono mode. A signal feeding channel 2 will work against the channel 1 signal, and usually results in distortion and inefficient operation.

Connect the load across the two positive (+) output ter-

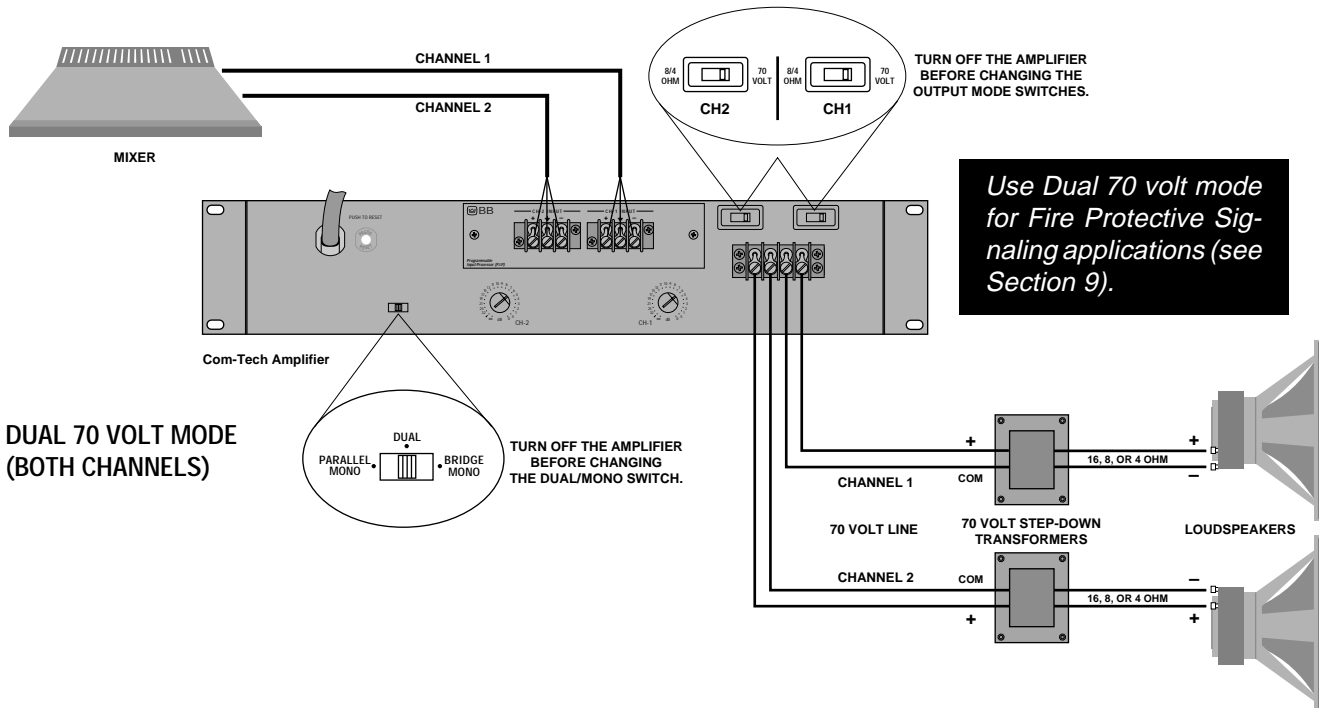
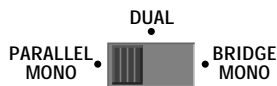

Fig. 3.5 Wiring for Dual 70 Volt Mode

! minals (see Figure 3.6 and the middle illustration in Figure 3.7). The positive lead from the load connects to the positive channel 1 terminal, and the negative (or ground) lead from the load connects to the positive channel 2 terminal. Do not connect the output grounds (\pm). Also, the load must be balanced (neither side shorted to ground).

CAUTION: Only connect balanced equipment (meters, switches, etc.) to the Bridge-Mono output. Both sides of the line must be isolated from the input grounds or oscillations may occur.



PARALLEL-MONO

! Parallel-Mono mode is used to drive loads with a total impedance of less than 4 ohms when using 8/4 ohm output mode (see *Bridge-Mono* if the load is greater than 4 ohms). This mode can also be used to drive a

single high-powered 70 volt constant voltage line.

Parallel-Mono installation is very different from the other modes and requires special attention.

WARNING: Both channels must be configured for the same output mode (8/4 ohm or 70 volt) before switching to Parallel-Mono mode.

To select Parallel-Mono mode, turn off the amplifier and slide the dual/mono switch to the left (as you face the back panel). Connect the input signal to channel 1 only. The channel 2 input jack and level control are bypassed in this mode, so they should not be used.

Note: It is normal for the channel 2 IOC indicator to stay on in Parallel-Mono mode.

Connect the load to the channel 1 output as shown in Figure 3.7 (top and bottom illustrations). The positive lead from the load connects to the positive (+) terminal of channel 1, and the negative (or ground) lead from the load connects to the ground (\pm) terminal of channel 1. Finally, install a jumper wire of at least 14 gauge be-

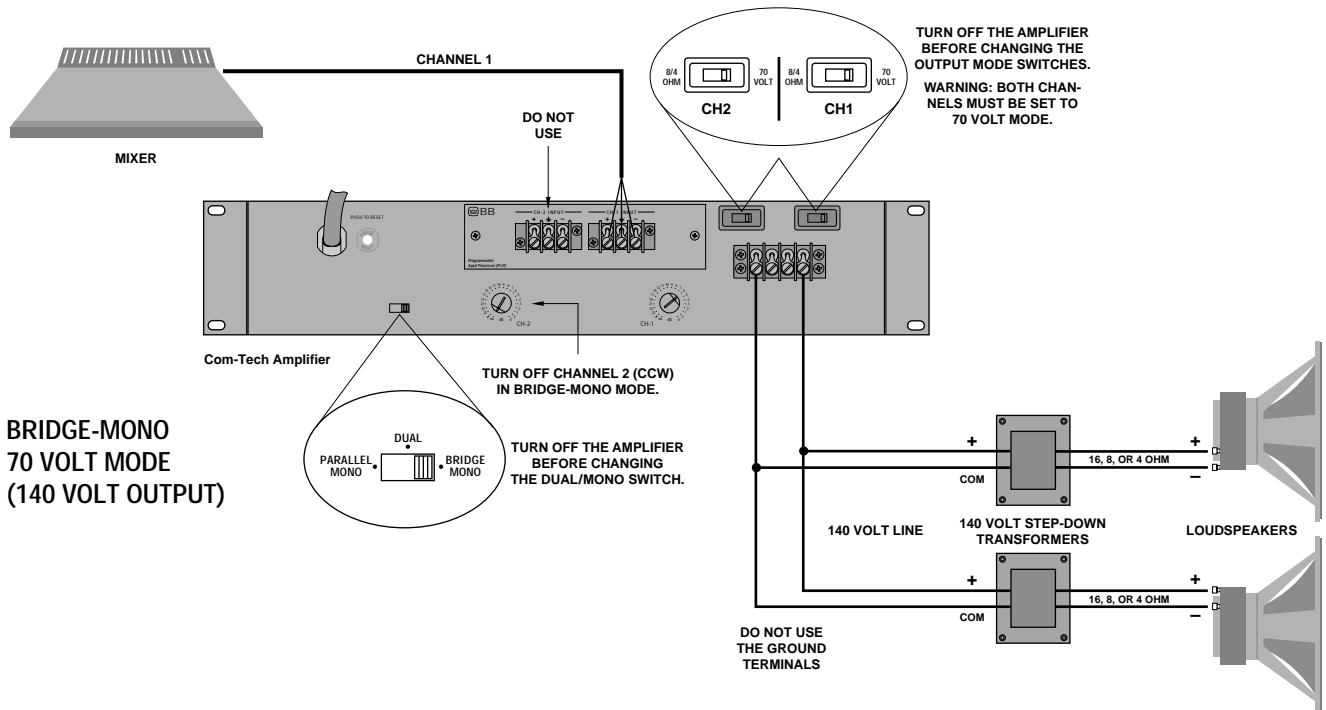

Fig. 3.6 Wiring for Bridge-Mono 70 Volt Mode (140 Volt Output)

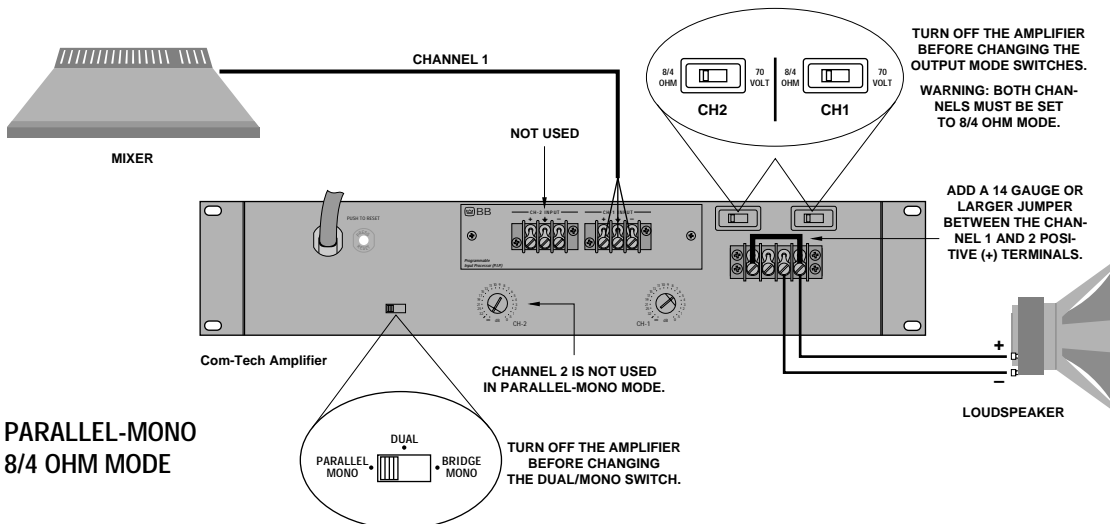
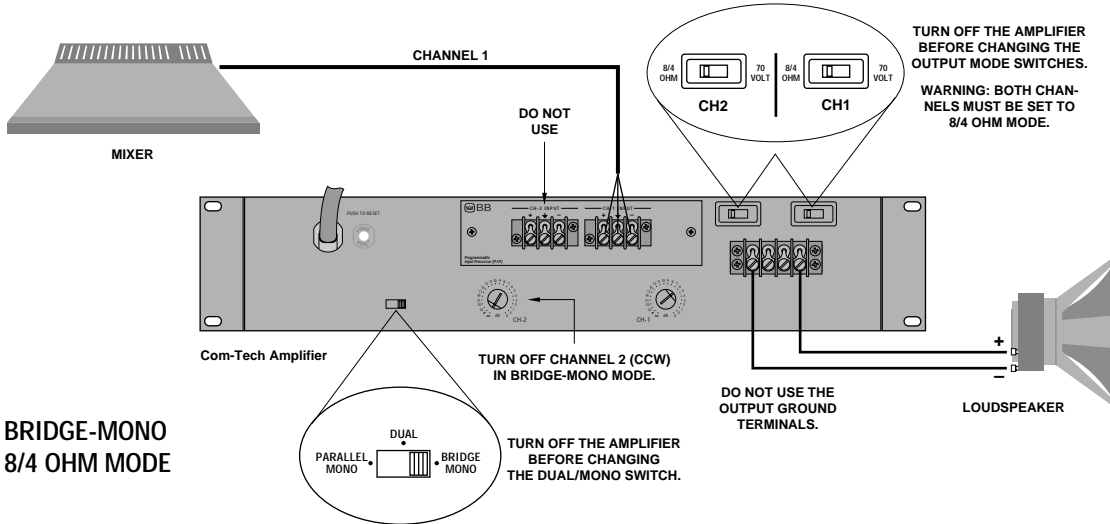
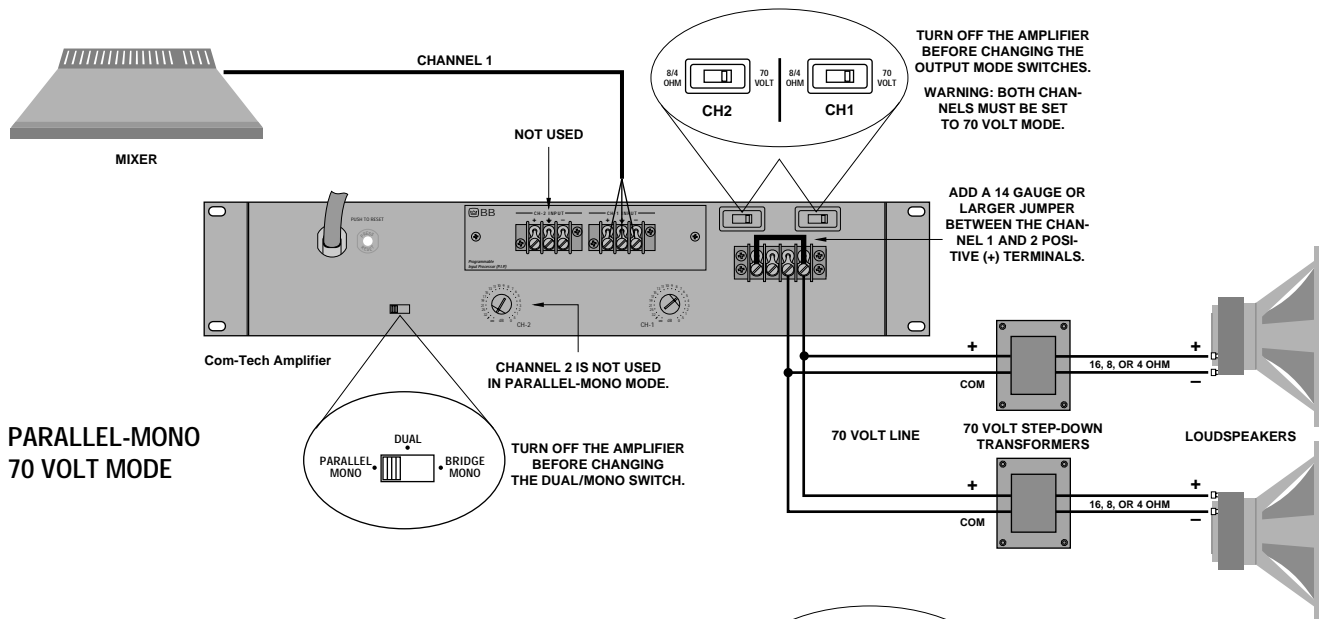

Fig. 3.7 Wiring for Parallel-Mono 70 Volt, Bridge-Mono 8/4 Ohm and Parallel-Mono 8/4 Ohm Modes

tween the positive (+) terminals of both channels.

CAUTION: When Parallel-Mono wiring is installed, do not attempt to operate in Dual or Bridge-Mono mode until the wiring is removed (especially the jumper wire). Failure to do so will result in high distortion and excessive heating.

3.3.2 Input Connection

The balanced inputs have a nominal impedance of 20 K ohms (10 K ohms unbalanced) and will accept the line-level output of most devices. The factory-installed P.I.P.-BB provides a balanced three-terminal input barrier block for each channel (see Figure 2.2). Optional P.I.P. modules like the P.I.P.-FX, P.I.P.-FXQ and P.I.P.-FPX can provide female XLR connectors, phone jacks and phono (RCA) connectors. Various P.I.P.s are also available which provide a wide range

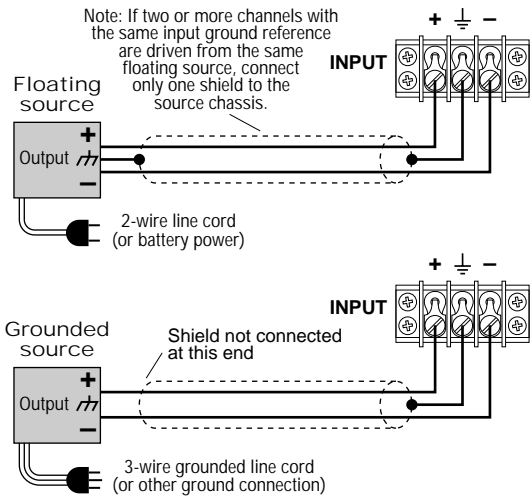

Fig. 3.9 Balanced Input Wiring

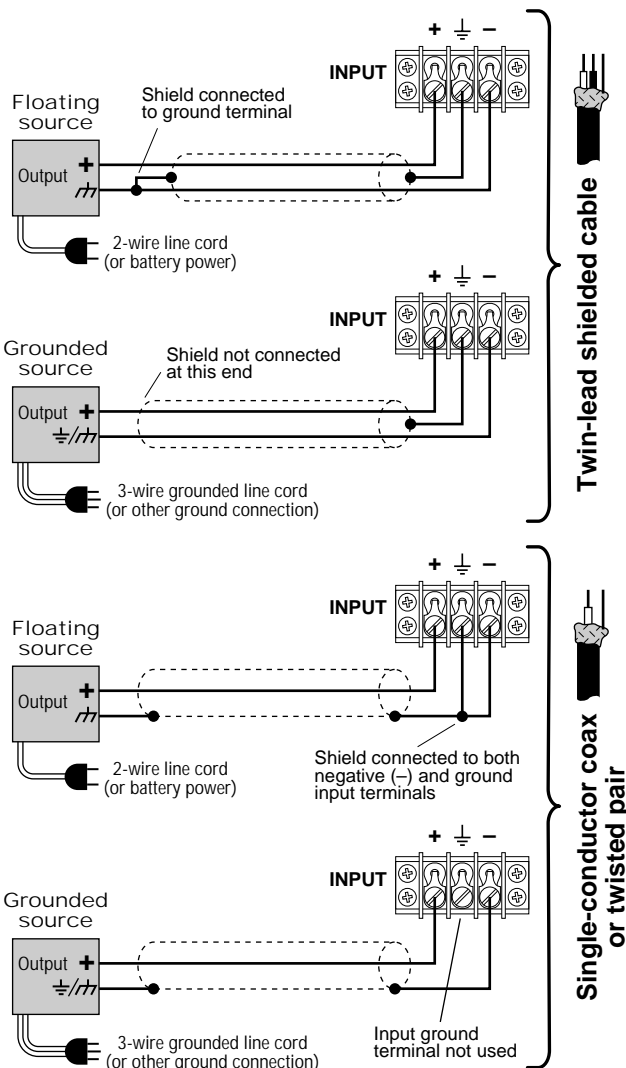

Fig. 3.8 Unbalanced Input Wiring

of input signal processing features (see Section 8).

Proper input wiring depends on two factors: (1) whether the input signals are balanced or unbalanced, and (2) whether the signal source floats or has a ground reference. The following illustrations provide examples of recommended connection techniques for each type of signal source.

SOLVING INPUT PROBLEMS

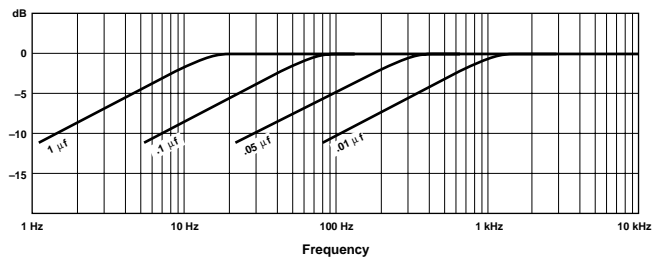

Fig. 3.10 Subsonic Filter Capacitor Values

Sometimes large **subsonic** (subaudible) **frequencies** are present in the input signal. These can damage loudspeakers or step-down transformers by overloading or overheating them. To attenuate such frequencies, place a capacitor in series with the input signal line. The graph in Figure 3.10 shows some capacitor values and how they affect frequency response. Use only low-leakage capacitors.

Another problem to avoid is large levels of **radio frequencies** or RF in the input signal. Although high RF levels may not pose a threat to the amplifier, they can burn out tweeters or other loads that are sensitive to

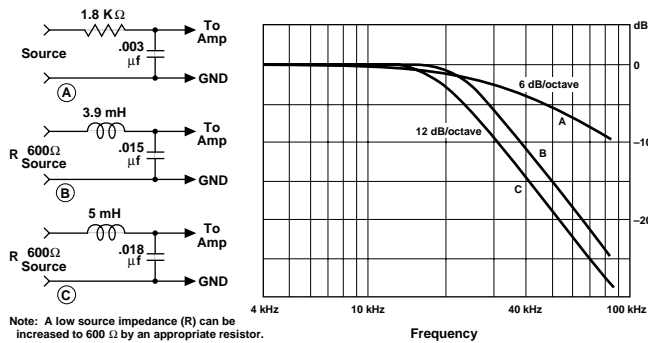

Fig. 3.11 Unbalanced RFI Filters

high frequencies. Extremely high RF levels can also cause your amplifier to prematurely activate its protection circuitry, resulting in inefficient operation. RF can be introduced into a signal by local radio stations and

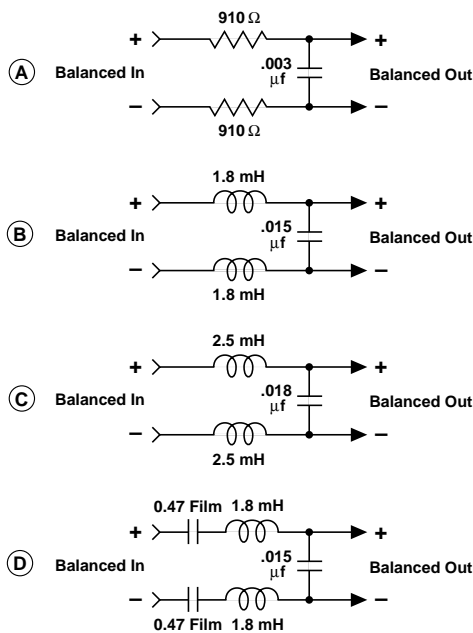

Fig. 3.12 Balanced RFI Filters

from the bias signal of many tape recorders. To prevent high levels of input RF, install an appropriate low-pass filter in series with the input signal. Some examples of unbalanced wiring for low-pass filters are shown in Figure 3.11.

For balanced input wiring, use an example from Figure 3.12. Filters A, B, and C correspond to the unbalanced filters shown in Figure 3.11. Filter D also incorporates the subsonic filter in Figure 3.10.

Input Wiring Tips

1. Use only shielded cable. Cables with higher density shields are better. Spiral wrapped shield is not recommended.
2. When using unbalanced lines, keep the cables as short as possible. Avoid cable lengths greater than 10 feet (3 meters).
3. Do not run signal cables together with high-level wiring such as loudspeaker wires or AC cords. This reduces the chance of hum or noise being induced into the input cables.
4. Turn the entire system off before changing connections. Turn level controls down before powering the system back up. Crown is not liable for damage incurred when any transducer or component is overdriven.

Tip: The standard P.I.P.-BB has plenty of space on its circuit board for the addition of input filter circuitry.

Another problem to avoid is **ground loops**. These are undesirable currents that flow in a grounded system and usually cause hum in the output. A common source of ground loop problems is the placement of input cables parallel to power cables or near power transformers. A ground loop can occur when the magnetic field generated by the 50/60 Hz alternating current in the power cable or transformer is induced into the input cables. To prevent this, you can lace the input cables along their length. (Lacing cables helps reduce magnetically induced current by minimizing the cross-sectional area between conductors which could bisect a magnetic field.) It is also very important to locate input cables away from power cables and transformers.

Ground loops often occur when the input and output grounds are tied together. **DO NOT CONNECT THE INPUT AND OUTPUT GROUNDS TOGETHER.** Tying the grounds together can also cause **feedback oscillation** from the load current flowing in the loop. To avoid this problem, use proper grounding, isolate the inputs, and isolate other common AC devices.

3.3.3 Output Connection

Consider the power handling capacity of your load before connecting it to the amplifier. Crown is not liable for damage incurred at any time due to overpowering. Fusing loudspeaker lines is highly recommended (see Section 3.3.4). Also, please pay close attention to Sec-

Use Good Connectors

1. To prevent possible short circuits, do not expose the loudspeaker cable connectors.
2. Do not use connectors that might accidentally tie two channels together when making or breaking connections (for example, a standard three-wire stereo phone plug).
3. Connectors that can be plugged into AC power receptacles should never be used.
4. Connectors with low current-carrying capacity should not be used.
5. Connectors with any tendency to short should never be used.

tion 4.1, Precautions.

You should always install loudspeaker cables of sufficient gauge (wire thickness) for the length used. The resistance introduced by inadequate output cables will reduce the amplifier's power to and motion control of the loudspeakers. The latter problem occurs because the damping factor decreases as the cable resistance increases. This is very important because the amplifier's excellent damping factor can be easily negated by using insufficient cable.

Use the nomograph in Figure 3.13 and the following procedure to find the recommended wire gauge (AWG or American Wire Gauge) for your system.

1. Note the load resistance of the loudspeakers connected to each channel of the amplifier. If you are using 70 volt output, be sure to determine the load resistance of the step-down transformers (Crown's constant voltage computer can help with this, see Section 8.3). Mark this value on the "Load Resistance" line of the nomograph.
2. Select an acceptable damping factor and mark it on the "Damping Factor" line. Your amplifier can provide an excellent damping factor of 1,000 from 10 to 400 Hz in Stereo mode with an 8 ohm load. In contrast, typical damping factors are 50 or lower. Higher damping factors yield lower distortion and greater motion control over the loudspeakers. A common damping factor for commercial applications is between 50 and 100. Higher damping factors may be desirable for live sound, but long cable lengths often limit the highest damping factor that can be achieved practically. (Under these circumstances, Crown's *IQ System* is often used so amplifiers can be easily monitored and controlled when they are located very near the loudspeakers.) In recording studios and home hi-fi, a damping factor of 500 or more is very desirable.

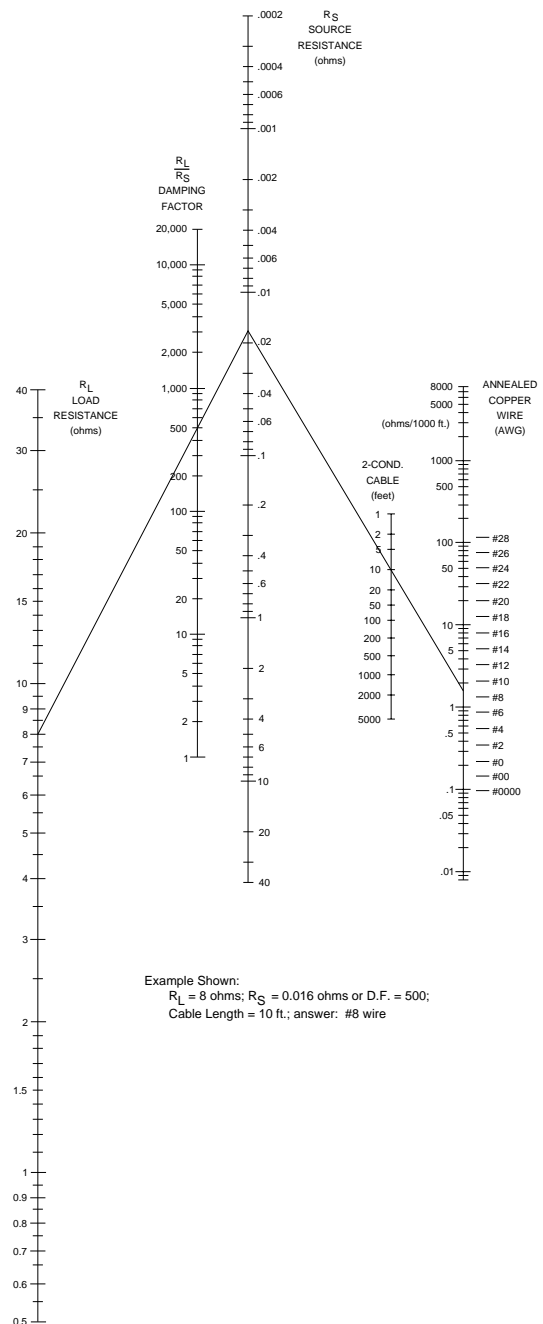

Fig. 3.13 Wire Size Nomograph

3. Draw a line through the two points with a pencil, and continue until it intersects the "Source Resistance" line.
4. On the "2-Cond. Cable" line, mark the length of the cable run.
5. Draw a pencil line from the mark on the "Source Resistance" line through the mark on the "2-Cond. Cable" line, and on to intersect the "Annealed Copper Wire" line.
6. The required wire gauge for the selected wire length and

damping factor is the value on the "Annealed Copper Wire" line. *Note: Wire size increases as the AWG gets smaller.*

7. If the size of the cable exceeds what you want to use, (1) find a way to use shorter cables, like using the *IQ System*, (2) settle for a lower damping factor, or (3) use more than one cable for each line. Options 1 and 2 will require the substitution of new values for cable length or damping factor in the nomograph. For option 3, estimate the effective wire gauge by subtracting 3 from the apparent wire gauge every time the number of conductors of equal gauge is doubled. So, if #10 wire is too large, two #13 wires can be substituted, or four #16 wires can be used for the same effect.

SOLVING OUTPUT PROBLEMS

High-frequency oscillations can cause your amplifier to prematurely activate its protection circuitry. The effects of this problem are similar to the RF problems described in Section 3.3.2. To prevent high-frequency oscillations, follow these guidelines:

1. Bundle together each pair of loudspeaker conductors when using long cable runs or when different amplifiers use a common cable tray or jacket. (Do NOT bundle wires from different amplifiers.) This reduces the chance of conductors acting like antennas to transmit or receive the high frequencies that can cause oscillation.
2. Avoid using shielded loudspeaker cable.
3. Never tie together input and output grounds.
4. Never tie together the output of different amplifiers.
5. Keep output cables separated from input cables.
6. Install a low-pass filter in series with each input (see Section 3.3.2).
7. Install the input wiring according to the instructions in Section 3.3.2.

Another problem to avoid is the presence of large **subsonic currents** when primarily inductive loads are used. Examples of inductive loads are 70 volt transformers and electrostatic loudspeakers.

Inductive loads can appear as a short circuit at low frequencies. This can cause the amplifier to produce

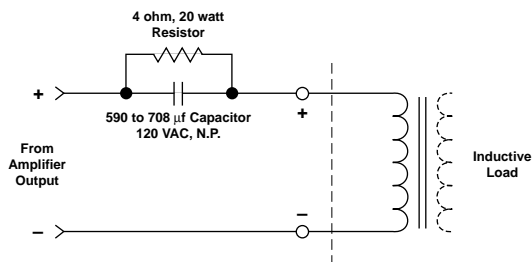

Fig. 3.14 Inductive Load (Transformer) Network

large low-frequency currents and activate its protection circuitry. Always take the precaution of installing a high-pass filter in series with the amplifier's input when inductive loads are used. A three-pole, 18 dB per octave filter with a -3 dB frequency of 50 Hz is recommended (some applications may benefit from an even higher -3 dB frequency). Such a filter is described with subsonic frequency problems in Section 3.3.2.

Another way to protect inductive loads from large low-frequency currents and prevent the amplifier from prematurely activating its protective systems is to parallel a 590 to 708 µF nonpolarized motor start capacitor and a 4 ohm, 20 watt resistor in series with the amplifier output and the positive (+) transformer lead. This circuit is shown in Figure 3.14. It uses components that are available from most electrical supply stores.

3.3.4 Additional Load Protection

Com-Tech amplifiers can generate enormous power output. Using 8/4 ohm output, if your loudspeakers do not have built-in protection from excessive power, it's a good idea to protect them. Loudspeakers are subject to thermal damage from sustained overpowering and

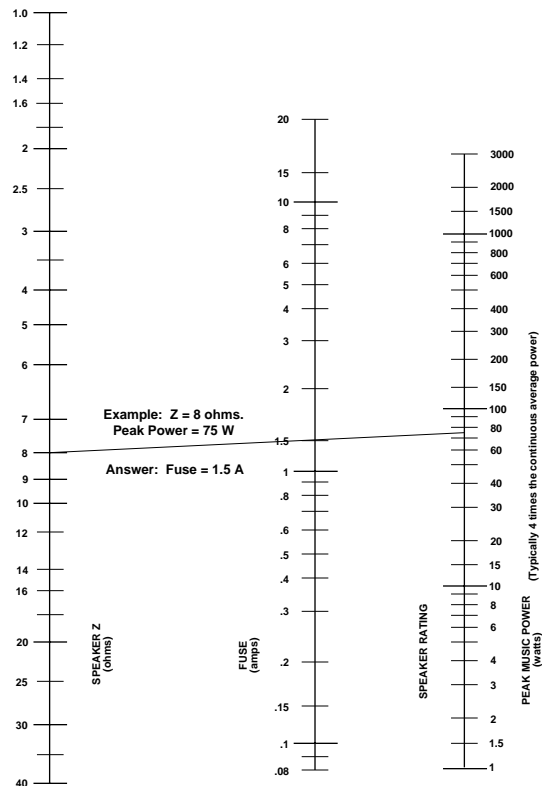

Fig. 3.15 Loudspeaker Fuse Nomograph

mechanical damage from large transient voltages. In both cases, special fuses may be used to protect your loudspeakers, or you may opt for the convenience of a *P.I.P.* module that provides loudspeaker protection.

Two different types of fuses are required for thermal protection and voltage protection. Slow-blow fuses are usually selected to protect loudspeakers from thermal damage because they are similar to loudspeakers in the way they respond to thermal conditions over time. In contrast, high-speed instrument fuses like the Littlefuse 361000 series are used to protect loudspeakers from large transient voltages. The nomograph in Figure 3.15 can be used to select the properly rated fuse for either type of loudspeaker protection.

There are mainly two different approaches used when installing fuses for loudspeaker protection. A common practice is to put a single fuse in series with the output of each channel. This makes installation easy because there is only one fuse per channel to install, but it can also lead to problems. The biggest disadvantage becomes apparent if the fuse blows because power to all connected loads will be removed.

A better approach is to fuse each driver independently. This allows you to apply the most appropriate protection for the type of driver being used. In general, low-frequency drivers (woofers) are most susceptible to thermal damage and high-frequency drivers (tweeters) are usually damaged by large transient voltages.

This means that your loudspeakers will tend to have better protection when the woofers are protected by slow-blow fuses and high-frequency drivers are protected by high-speed instrument fuses.

Depending on the application, you may want to use a *P.I.P.* module to protect your loudspeakers. When properly configured, all *P.I.P.* modules with signal-driven compression can provide loudspeaker protection. Some of the *P.I.P.* modules with signal-driven compression include the P.I.P.-AMCb, P.I.P.-EDCb and P.I.P.-PA. While the P.I.P.-EDCb is most commonly used for general loudspeaker protection, the P.I.P.-AMCb is very popular in systems that require a high-quality crossover, and the P.I.P.-PA is the processor of choice for applications that require a microphone and line level input for each channel. For more information on *P.I.P.* modules, see Section 8.

3.4 AC Mains Power

All 120 VAC, 60 Hz North American units have a NEMA 5-15 AC plug with an integral voltage presence lamp. These units include a 16 gauge cord with *Com-Tech 200s* and *400s*, and a 14 gauge cord with *Com-Tech 800s* and *1600s*. Other *Com-Tech* amplifiers are furnished with an appropriate AC cord and plug.





Use an isolated wall outlet whenever possible with the correct voltage and adequate current. Voltages greater than 10% above the specified AC mains voltage for the amplifier may damage the ± 15 volt regulator, filter capacitors and output transistors. See Section 7 for power requirements under various conditions.

All specifications in this manual were measured using 120 VAC, 60 Hz power mains unless otherwise noted. Specifications are derived using a mains voltage that is accurate to within 0.5% with THD less than 1.0% under all testing conditions. Performance variations can occur at other AC voltages and line frequencies. In addition, line regulation problems will directly affect the output power available from the amplifier.

4 Operation

4.1 Precautions

Although your amplifier is protected from internal and external faults, you should still take the following precautions for optimum performance and safety:

1. Improper wiring for the Dual, Bridge-Mono and Parallel-Mono modes, as well as the 8/4 ohm and 70 volt output modes can result in serious operating difficulties. Refer to Section 3.3.1 for details.
-  2. **WARNING: Never attempt to operate the amplifier in either Bridge-Mono or Parallel-Mono mode unless both output channels are configured the same (8/4 ohm or 70 volt).**
3. When driving an inductive load (like a 70 volt step-down transformer) use a high-pass filter or protective network to prevent premature activation of the amplifier's protection circuitry (see Section 3.3.3).
-  4. **WARNING: Do not change the position of the dual/mono switch or the output mode switches unless the amplifier is first turned off.**
-  5. **CAUTION: In Parallel-Mono mode, a jumper must be installed between the channel 1 and 2 positive (+) output terminals. Be sure to remove this jumper for Dual or Bridge-Mono modes, otherwise high distortion and excessive heating will occur. Check the dual/mono switch on the back panel for proper position.**
-  6. **Turn off the amplifier and unplug it from the AC mains before removing a P.I.P. card or before removing the dust filter.**
7. Use care when making connections, selecting signal sources and controlling the output level. The load you save may be your own!
8. Do not short the ground lead of an output cable to the input signal ground. This may form a ground loop and cause oscillations.
9. Operate the amplifier from AC mains of not more than 10% above or below the selected line voltage and only the specified line frequency.
-  10. **Never connect the output to a power supply output, battery or power main. Such connections may result in electrical shock.**
11. Tampering with the circuitry by unqualified personnel, or making unauthorized circuit changes may be hazardous and invalidates all agency listings.

Remember: Crown is not liable for damage that results from overdriving other system components.

4.2 Indicators

The front panel of a *Com-Tech* amplifier has several helpful indicators. The amber **Enable indicator** is provided to show the amplifier has been turned on (or enabled) and that its low-voltage power supply is working. It does not indicate the status of the high-voltage power supplies. For example, the Enable indicator will remain lit in the unlikely event that one of the amplifier's protection systems (described in Section 4.3) removes power from one (or both) high-voltage supplies to put the channel in "standby" mode. The Enable indicator will be illuminated for all conditions shown in Figure 4.1 except for the first example, "There is no power to the amplifier."

The green **ODEP indicators** confirm the normal operation of Crown's patented Output Device Emulation Protection circuitry. During normal operation, they glow brightly to confirm the presence of reserve thermal-dynamic energy. They dim proportionally as the energy reserve decreases. In the rare event that there is no reserve, the indicators will turn off and *ODEP* will proportionally limit the drive level of the output stages so the amplifier can continue safe operation even when conditions are severe. (For a more detailed description of *ODEP*, see Section 4.3.1.)

A channel's *ODEP* indicator also turns off if its high-voltage power supply is put in "standby" mode or the amplifier's circuit breaker is tripped. The standby mode is activated if DC or heavy common-mode current is detected at the output, if the transformer thermal protection system is activated, or if a *P.I.P.* like the *P.I.P.-UL1711* or the *IQ-P.I.P.* is used to shut down a high-voltage power supply. (For more information, see Section 4.3.3 and the table in Figure 4.1.)

The yellow **IOC indicators** act as sensitive distortion meters to provide *proof of distortion-free performance*. The *IOC* (Input/Output Comparator) circuitry compares the incoming signal's waveform to that of the output. Any difference between the two is distortion. The *IOC* indicators flash if there is a difference of 0.05% or more. It is normal for them to light momentarily when the amplifier is first turned on. *Note: the channel 2 IOC indicator will stay on in Parallel-Mono mode.*

The green **Signal Presence Indicators (SPI)** flash synchronously with the output audio. The SPI detector circuit is connected in the signal path after the input gain stages and level controls, so a flashing indicator tells you that there is audio in and out of the amplifier. *Note: The Signal Presence Indicators may not report signal presence if the output signal level is too low.*

Indicator Status	Amplifier Condition
ODEP — OFF IOC — OFF SPI — OFF	There is no power to the amplifier. Possible reasons: (1) The amplifier's Enable switch is off. (2) The amplifier is not plugged into the power receptacle. (3) The AC mains circuit breaker has been tripped. (4) The amplifier's back panel circuit breaker has been tripped. (5) The amplifier's low-voltage power supply fuse has blown.
ODEP — ON IOC — OFF SPI — OFF	Normal operation for a channel with NO output. Possible reasons: (1) There is no input signal. (2) The channel's level control is turned down.
ODEP — OFF IOC — ON SPI — OFF	No output: The amplifier channel is in standby mode. Possible reasons: (1) The amplifier has just been turned on and is still in the four second turn-on delay. (2) A P.I.P. module such as an IQ-P.I.P. or the P.I.P.-UL1711 has turned off the channel's high-voltage supply.
ODEP — OFF IOC — OFF SPI — Active	ODEP limiting is about to begin. Possible reasons: (1) The amplifier's air filters are blocked and need to be cleaned. (2) There is insufficient cooling because of inadequate air flow or air that is too hot. (3) The load impedance for the channel is too low because the output is shorted or the amplifier is driving too many loudspeakers for the selected dual/mono mode. (4) The amplifier channel is continuously being driven to very high output levels.
ODEP — ON IOC — ON SPI — OFF	No output: The amplifier channel is in standby mode. Possible reasons: (1) The DC/low-frequency protection circuitry has been activated. (2) The fault protection circuitry has been activated after sensing heavy common-mode current. (3) The transformer thermal protection circuitry has been activated. OR Channel 2 only: The amplifier is in Parallel-Mono mode with no output. The channel 2 IOC indicator always turns on when the amplifier's dual/mono switch is moved to the Parallel-Mono position.
ODEP — ON IOC — OFF SPI — Active	Normal operation with an input signal. The signal presence indicator (SPI) will flash to show that an audio signal is present.
ODEP — OFF IOC — ON SPI — Active	ODEP limiting has been activated. Possible reasons: (1) The amplifier's air filters are blocked and need to be cleaned. (2) There is insufficient cooling because of inadequate air flow or air that is too hot. (3) The load impedance for the channel is too low because the output is shorted or the amplifier is driving too many loudspeakers for the selected dual/mono mode. (4) The amplifier channel is continuously being driven to very high output levels.
ODEP — ON IOC — ON SPI — Active	The channel's output is exceeding 0.05% distortion. The input signal level is too high, and IOC is reporting either an input overload or output clipping. OR Channel 2 only: The amplifier is in Parallel-Mono mode and has output. The channel 2 IOC indicator always turns on when the amplifier's dual/mono switch is moved to the Parallel-Mono position.

Fig. 4.1 ODEP, IOC and Signal Presence Indicator States

4.3 Protection Systems

Com-Tech amplifiers provide extensive protection and diagnostics capabilities. Protection systems include ODEP, "standby" and an AC circuit breaker. These features provide protection under any conditions.

4.3.1 ODEP

Crown invented ODEP to solve two long-standing problems in amplifier design: to prevent amplifier shutdown during demanding operation, and to increase the efficiency of the output circuitry.

To do this, Crown established a rigorous program to measure the *safe operating area* (SOA) of each output device before installing it in an amplifier. Next, Crown designed intelligent circuitry to simulate the instantaneous operating conditions of the output devices. Its name describes what it does: Output Device Emulation Protection or ODEP. In addition to simulating the operating conditions of the output devices, it also compares their operation to their known SOA. If ODEP sees that more power is about to be asked of the output devices than they are capable of delivering under the

present conditions, *ODEP* immediately limits the drive level until it falls within the SOA. Limiting is proportional and kept to an absolute minimum—only what is required to prevent output device damage.

This level of protection enables Crown to increase output efficiency to never-before-achieved levels while greatly increasing amplifier reliability.

The on-board intelligence is monitored in two ways. First, the front panel *ODEP* indicators show whether the amplifier is functioning correctly or if *ODEP* is limiting the drive level. Second, *ODEP* data is fed to the connector inside the amplifier's back panel *P.I.P.* compartment so advanced *P.I.P.* modules like the IQ-P.I.P. can use it to monitor and control the amplifier.

This is how *ODEP* keeps the show going with maximum power and maximum protection at all times.

4.3.2 Standby Mode

An important part of a *Com-Tech* amplifier's protection systems is standby mode. Standby protects the amplifier during potentially catastrophic conditions. It temporarily removes power from the high-voltage supplies to protect the amplifier and its loads. Standby mode can be identified using the indicator table in Figure 4.1.

When you turn on the Enable switch, standby mode is activated to provide **turn-on protection**. This power-up delay lets other system components settle before any signals are amplified, and it provides some "randomness" to the power-up sequence of multiple units which reduces the system's current demand during start-up.

If dangerous subsonic frequencies or direct current (DC) is detected in the amplifier's output, the unit will activate its **DC/low-frequency protection** circuitry and put the affected channels in standby. This protects the loads and prevents oscillations. The unit resumes normal operation as soon as the amplifier no longer detects dangerous low-frequency or DC output. Although it is extremely unlikely that you will ever activate the amplifier's DC/low-frequency protection system, improper source materials such as subsonic square waves or input overloads that result in excessively clipped input signals can activate this system.

The amplifier's **fault protection** system will put an amplifier channel into standby mode in rare situations where heavy common-mode current is detected in a channel's output. The amplifier should never output heavy common-mode current unless its circuitry is damaged in some way, and putting the channel in

standby mode helps to prevent further damage.

The amplifier's **transformer thermal protection** circuitry is activated in very unusual circumstances where the unit's transformer temperature rises to unsafe levels. Under these abnormal conditions, the amplifier will put both channels into standby mode. In addition, the cooling fan will run at full speed. The amplifier will return to normal operation after the transformer cools to a safe temperature. (For more information on transformer thermal protection, refer to the section that follows.)

4.3.3 Transformer Thermal Protection

All *Com-Tech* amplifiers have transformer thermal protection which protects the power supplies from damage under rare conditions where the transformer temperature rises too high. A thermal switch embedded in the power transformer removes power to the high-voltage power supplies if it detects excessive heat. The switch automatically resets itself as soon as the transformer cools to a safe temperature.

If your amplifier is operated within rated conditions, it is extremely unlikely that you will ever see it activate transformer thermal protection. One reason is that *ODEP* keeps the amplifier working under very severe conditions. Even so, higher than rated output levels, excessively low-impedance loads and unreasonably high input signals can generate more heat in the transformer than in the output devices. This can overheat the transformer and activate its protection system.

Com-Tech amplifiers are designed to keep working under conditions where other amplifiers would fail. But even when the limits of a *Com-Tech* are exceeded, it still protects itself—and your investment—from damage.

4.3.4 Circuit Breaker

A circuit breaker is provided to prevent excessive current draw by the high-voltage power supplies. A reset switch for the circuit breaker is provided on the back panel. The rating of the circuit breaker for each amplifier model and each AC mains voltage is provided with the specifications in Section 6. When operating with rated loads and output levels, this breaker should only trip in the incredibly rare instance of a catastrophic amplifier failure. Other protection systems such as *ODEP* keep the amplifier safe and operational under most other severe conditions. The breaker can also trip in situations where extremely low-impedance loads and high output levels result in current draw that exceeds the breaker's rating. Again, this should only be possible when operating *outside rated conditions*,

like when the amplifier is used to drive a 1 ohm load, or when an input signal is clipped severely.

4.4 Controls

The **Enable switch** is located on the front panel so you can easily turn the amplifier on and off. If you ever need to make any wiring or installation changes, don't forget to disconnect the power cord. Please follow these steps when first turning on your amplifier:

1. Turn down the level of your audio source. For example, set your mixer's volume to -10 .
2. Turn down the level controls of the amplifier.
3. Turn on the Enable switch. The Enable indicator beside the switch should glow. During the four second turn-on delay which immediately follows, the indicators will flash as described in Figure 4.1. After the delay, the *ODEP* indicators should come on with full brilliance and the *IOC* and Signal Presence Indicators should function normally.
4. After the turn-on delay, turn up the level of your audio source to the maximum desired level.
5. Turn up the level controls on the back panel of the amplifier until the maximum desired loudness or power level is achieved.
6. Turn down the level of your audio source to its normal range.

A 22-position detented **level control** is provided for each channel. For security, the level controls are located on the back panel. To prevent tampering from the rear, a Lexan cover is provided that can be attached to the back panel with the included $\frac{1}{2}$ " 8-32 screws.

Com-Tech amplifiers have a back panel **reset switch** for the AC mains circuit breaker. If the circuit breaker trips for some reason, the Enable indicator will turn off. In this situation, turn off the Enable switch and reset the circuit breaker. Then turn the Enable switch back on. If the breaker trips again or if the unit fails to operate properly, contact an authorized service center or Crown's Technical Support Group.

A three-position **input sensitivity switch** is located inside the amplifier's *P.I.P.* compartment. It is set at the factory to a sensitivity of 0.775 volts (8/4 ohm mode). Please notice that there is a separate 0.775 volt position for 70 volt mode. If desired, the sensitivity can be switched to a voltage gain of 26 dB. With 26 dB gain and 70 volt output, the input sensitivity for all models is 3.5 volts. With 26 dB gain and 8/4 ohm output, the input sensitivity varies among the different amplifier

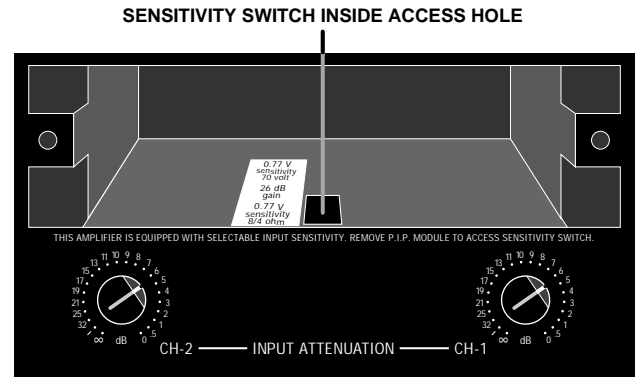

Fig. 4.2 Input Sensitivity Switch

models. To generate standard 1 kHz power, the input voltage required is 1.48 volts for the *Com-Tech 200*, 2.12 volts for the *Com-Tech 400*, 2.47 volts for the *Com-Tech 800* and 3.29 volts for the *Com-Tech 1600*.

It is also possible to configure the amplifier with one channel set to 8/4 ohm output and the other set to 70 volt. With this configuration, the input sensitivity switch should be set to 0.775 volts (70 volt), and the level control for the 8/4 ohm channel can be adjusted to compensate for the additional gain.

To change the input sensitivity:

1. Turn off the amplifier and disconnect the power cord from the receptacle.
2. Remove the *P.I.P.* module.
3. Locate the access hole for the sensitivity switch inside the chassis opening (Figure 4.2).
Note: The sensitivity switch will not be visible because it is mounted below the hole. Use your little finger to reach it.
4. Set the switch to the desired position noted on the access hole label.
5. Replace the *P.I.P.* module and restore power.

4.5 Filter Cleaning

A dust filter is provided on the amplifier's air intake (Figure 2.1). If this filter becomes clogged, the unit will not cool as efficiently as it should and high heat sink temperatures may produce lower-than-normal output.

To clean the filter, use a phillips screwdriver to remove the screws that hold the front panel grille in place. Use mild dishwashing detergent and warm water for best cleaning results. Replacement filters may be ordered from the factory.

Dust filters are not 100% efficient—long term this may require internal heat sink cleaning by a qualified technician. Internal cleaning information is available from our Technical Support Group.

5 Technical Information

5.1 Overview

Com-Tech amplifiers incorporate several new technological advancements including real-time computer simulation, low-stress output stages, an advanced heat sink embodiment and the Programmable Input Processor (*P.I.P.*) expansion system.

Custom circuitry is incorporated to limit temperature and current to safe levels making it highly reliable and tolerant of faults. Unlike many lesser amplifiers, it can operate at its voltage and current limits without self-destructing.

Real-time computer simulation is used to create an analogue of the junction temperature of the output transistors (hereafter referred to as the output devices). Current is limited only when the device temperature becomes excessive (and by the minimum amount required). This patented approach called Output Device Emulation Protection (or *ODEP*) maximizes the available output power and protects against overheating—the major cause of device failure.

The amplifier is protected from all common hazards that plague high-power amplifiers, including shorted, open or mismatched loads; overloaded power supplies, excessive temperature and chain-destruction phenomenon; input overload, high-frequency blow-ups, internal faults, and input and output DC.

The four-quadrant topology used in a *Com-Tech* amplifier's output stages is called the *grounded bridge*. This patented topology makes full use of the power supply providing peak-to-peak voltages to the load that are twice the voltage seen by the output devices (see Figure 5.1).

As its name suggests, the *grounded bridge* topology is referenced to ground. Composite devices are constructed to function as gigantic NPN and PNP devices to handle currents which exceed the limits of available devices. Each output stage has two composite NPN devices and two composite PNP devices.

The devices connected to the load are referred to as "high-side NPN and PNP" and the devices connected to ground are referred to as "low-side NPN and PNP." Positive current is delivered to the load by increasing conductance simultaneously in the high-side NPN and low-side PNP stage, while synchronously decreasing conductance of the high-side PNP and low-side NPN.

The two channels may be used together to double the voltage (Bridge-Mono) or current (Parallel-Mono) pre-

sented to the load. This feature gives you flexibility to maximize power available to the load.

A wide bandwidth, multiloop design is used for state-of-the-art compensation. This produces ideal behavior and results in ultra-low distortion values.

Aluminum extrusions have been widely used for heat sinks in power amplifiers due to their low cost and reasonable performance. However, measured on a watts per pound or watts per volume basis, the extrusion technology doesn't perform nearly as well as the heat sink technology developed for *Com-Tech* amplifiers.

Our heat sinks are fabricated from custom convoluted fin stock that provides an extremely high ratio of area to volume, or area to weight. All power devices are mounted directly to massive heat spreaders that are electrically at the V_{CC} potential. Electrifying the heat spreaders improves thermal performance by eliminating the insulating interface underneath each power device. The chassis itself is used as part of the thermal circuit to maximize utilization of the available cooling resources.

5.2 Circuit Theory

Each channel is powered by its own power transformer winding. Both channels share a common low-voltage supply. The secondary output of T100 is full-wave rectified by D109 and is filtered by a large computer grade capacitor. A thermal switch embedded in the power transformer protects it from overheating.

The low-voltage winding of the transformer is rectified by diodes D1, D2, D3 and D4 to generate an unregulated 24 volts. Monolithic regulators U1 and U2 provide a regulated ± 15 volts.

5.2.1 Dual Operation

For simplicity, the discussion of Dual operation will refer to one channel only. Mono operation will be discussed in Sections 5.2.2 and 5.2.3.

Please refer to the block diagram in Figure 5.1 and the schematics provided at the back of this manual.

The signal at the *P.I.P.* barrier block passes directly into the balanced input stage (U104-A). The balanced input stage causes balanced to single-ended conversion using a difference amplifier. Next the variable gain stage (U104-B) amplifies or attenuates the signal. The gain of this stage is set by the position of the input sen-

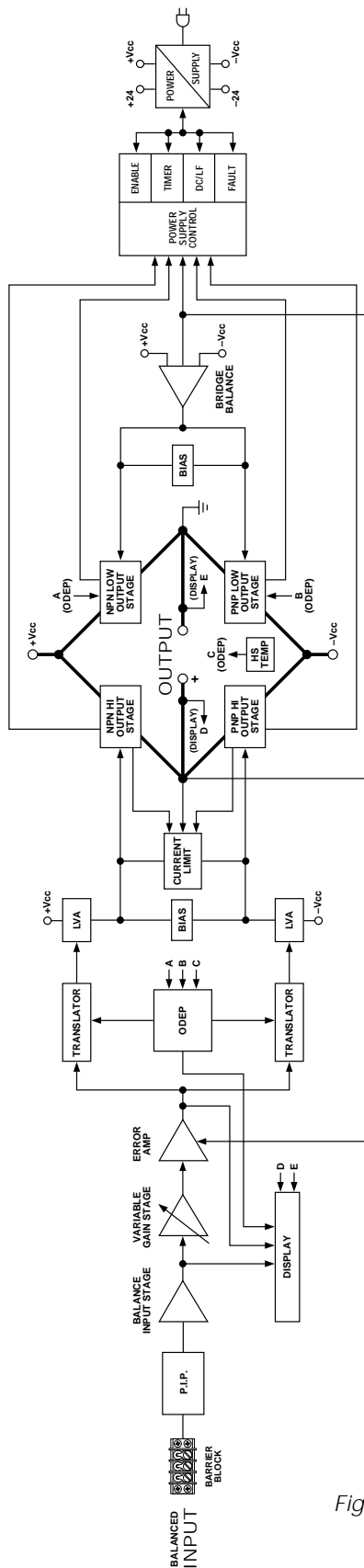

ONLY ONE CHANNEL SHOWN

Fig. 5.1 Circuit Block Diagram

sitivity switch and the back panel level control. The error amp (U104-C) amplifies the difference between the output signal and the input signal from the gain pot, and drives the voltage translator stage.

From the error amp, the voltage translator stage channels the signal to the Last Voltage Amplifiers (LVAs), depending on the signal polarity. The +LVA (Q105) and the -LVA (Q110), with their push-pull effect through the bias servo Q318, drive the fully complementary output stage.

The bias servo Q318 is thermally coupled to the heat sink, and sets the quiescent bias current in the output stage to lower the distortion in the crossover region of the output signal. D301, D302, D303, and D304 are used to remove the charge on the unused portion of the output stage, depending on the polarity of the output signal.

With the voltage swing provided by the LVAs, the signal then gains current amplification through the Darlington emitter-follower output stage.

The bridge-balanced circuit (U104-D) receives a signal from the output of the amplifier, and differences it with the signal at the Vcc supply. The bridge-balanced circuit then develops a voltage to drive the bridge-balanced output stage. This results in the Vcc supply having exactly one half of the output voltage added to their quiescent voltage. D309, D310, D311 and a trimmer resistor set the quiescent current point for the bridge-balanced output stage.

The protection mechanisms that affect the signal path are implemented to protect the amplifier under real world conditions. These conditions are high instantaneous current, excessive temperature, and output device operation outside safe conditions.

Q107 and Q108 act as a conventional current limiter, sensing current in the output stage. When current at any one instant exceeds the design criteria, the limiters remove the drive from the LVAs, thus limiting current in the output stage to a safe level.

To further protect the output stages, the patented *ODEP* circuitry is used. It produces an analog output proportional to the always changing *safe operating area* of the output transistor. This output controls the translator stage previously mentioned, removing any further drive that may exceed the *safe operating area* of the output stage.

Thermal sensors S100 and S200 give the *ODEP* circuits vital information on the operating temperature of the heat sink on which the output devices are mounted.

Should the amplifier fail in a way that would cause DC across the output lead, the DC protection circuit senses this on the negative feedback loop and shuts down the power supply until the DC is removed.

5.2.2 Bridge-Mono Operation

By setting the dual/mono switch on the back panel to Bridge-Mono, the user can convert the *Com-Tech* into a bridge-mono amplifier. With a signal applied to the channel 1 input jack, and the load between the positive (+) output terminals on the back panel, twice the voltage can be output.





The channel 1 output feeds the channel 2 error amp U204-A. Because there is a net inversion, the channel 2 output is out of polarity with channel 1. This produces twice as much voltage across the load. Each of the channel's protection mechanisms work independently if a fault occurs.

5.2.3 Parallel-Mono Operation

With the dual/mono switch set to Parallel-Mono, the output of channel 2 is paralleled with the output of channel 1. A suitable high current-handling jumper must be connected across the positive (+) output terminals to gain the benefits of this operating mode.

The signal path for channel 1 is the same as previously discussed, except that channel 1 also drives the output stage of channel 2. The channel 2 balanced input, error amp, translators and LVAs are disconnected and no longer control the channel 2 output stage. Disconnecting the front-end stages from the output causes the channel 2 IOC circuit to note that the input waveform (which is absent) does not match the output waveform (which is driven by the channel 1 input). This is why the channel 2 IOC light is activated any time the amplifier is switched into Parallel-Mono mode. The channel 2 output stage and protection mechanisms are also coupled through S1 and function as one.

In Parallel-Mono mode, twice the current of a single channel is available. Because the channel 2 *ODEP* circuit is coupled through S1, you have added protection if a fault occurs in the channel 2 output stage. The channel 2 *ODEP* circuit will limit the output of both output stages by removing the drive from the channel 1 translator stages.

	Approved for THX Theatre Systems (CT-400 & 800)	120 VAC North American Units:		Commercial Audio E106377		Fire Protective Signaling S5206		Commercial Audio LL 32521C
---	--	--	---	--------------------------------	--	---------------------------------------	---	----------------------------------

6 Specifications

The following specifications apply to all models in Dual mode with 8 ohm loads and an input sensitivity of 26 dB unless otherwise specified. In Fire Protective Signaling Applications, the specifications in Section 9 supersede several of the specifications that follow.

Standard 1 kHz Power: This term refers to maximum average power in watts at 1 kHz with 0.1% THD.

Full Bandwidth Power: This term refers to maximum average power in watts from 20 Hz to 20 kHz with 0.1% THD.

120 VAC, 60 Hz Units: These North American units have dedicated transformers for 120 VAC, 60 Hz power mains.

100/120 VAC Units: These units have two-tap transformers that accept a 50 or 60 Hz AC line, and can be configured for 100 or 120 VAC mains.

220/240 VAC Units: These units have two-tap transformers that accept a 50 or 60 Hz AC line, and can be configured for 220 or 240 VAC mains.

Performance

Frequency Response: ± 0.1 dB from 20 Hz to 20 kHz at 1 watt (see Figure 6.9).

Phase Response: ± 10 degrees from 10 Hz to 20 kHz at 1 watt (see Figure 6.12).

Hum and Noise: A-weighted, 105 dB below full bandwidth power; No weighting, 100 dB below full bandwidth power.

Total Harmonic Distortion (THD): Less than 0.05% at full bandwidth power from 20 Hz to 1 kHz increasing linearly to less than 0.1% at 20 kHz.

Intermodulation Distortion (IMD): (60 Hz and 7 kHz 4:1) Less than 0.05% from less than 166 milliwatts to full bandwidth power.

Damping Factor: Greater than 1000 from 10 Hz to 400 Hz (see Figure 6.10).

Crosstalk: See Figure 6.13.

Common Mode Rejection Ratio (CMRR): Better than 70 dB.

Slew Rate: Greater than 17 volts per microsecond.

Voltage Gain: (At the maximum level setting) 20:1 $\pm 3\%$ or 26 dB ± 0.25 dB. 90:1 $\pm 12\%$ or 39 dB ± 1 dB with the input sensitivity set to 0.775 volts for 70 volt output. The following voltage gain specifications are for units with the input sensitivity set to 0.775 volts for 8/4 ohm output:

Com-Tech 200: 38:1 $\pm 12\%$ or 32 dB ± 1 dB.

Com-Tech 400: 55:1 $\pm 12\%$ or 35 dB ± 1 dB.

Com-Tech 800: 64:1 $\pm 12\%$ or 36 dB ± 1 dB.

Com-Tech 1600: 85:1 $\pm 12\%$ or 39 dB ± 1 dB.

Power

Output Power: *The following are guaranteed minimums for standard 1 kHz power from 120 VAC, 60 Hz North American units. For more information or specs on international units, see the power matrices that follow.*

Com-Tech 200

Dual mode (with both channels driven):

150 watts into 4 ohms.

110 watts into 8 ohms.

110 watts with 70 volt output.

Bridge-Mono mode:

300 watts into 8 ohms.

220 watts into 16 ohms.

205 watts in 70 volt mode (140 volt output).

Parallel-Mono mode:

295 watts into 2 ohms.

215 watts into 4 ohms.

210 watts with 70 volt output.

Com-Tech 400

Dual mode (with both channels driven):

240 watts into 4 ohms.

220 watts into 8 ohms.

225 watts with 70 volt output.

Bridge-Mono mode:

475 watts into 8 ohms.

450 watts into 16 ohms.

455 watts in 70 volt mode (140 volt output).

Parallel-Mono mode:

- 440 watts into 2 ohms.
- 440 watts into 4 ohms.
- 455 watts with 70 volt output.

Com-Tech 800*Dual mode (with both channels driven):*

- 490 watts into 4 ohms.
- 305 watts into 8 ohms.
- 460 watts with 70 volt output.

Bridge-Mono mode:

- 975 watts into 8 ohms.
- 610 watts into 16 ohms.
- 920 watts in 70 volt mode (140 volt output).

Parallel-Mono mode:

- 965 watts into 2 ohms.
- 610 watts into 4 ohms.
- 915 watts with 70 volt output.

Com-Tech 1600*Dual mode (with both channels driven):*

- 870 watts into 4 ohms.
- 540 watts into 8 ohms.
- 960 watts with 70 volt output.

Bridge-Mono mode:

- 1,745 watts into 8 ohms.
- 1,080 watts into 16 ohms.
- 1,805 watts in 70 volt mode (140 volt output).

Parallel-Mono mode:

- 1,745 watts into 2 ohms.
- 1,080 watts into 4 ohms.
- 1,780 watts with 70 volt output.

It is extremely important to supply the amplifier with adequate AC power. Power amplifiers cannot create energy—they need the required voltage and current to deliver the undistorted rated wattages you expect.

Load Impedance: Safe with all types of loads. With 8/4 ohm output, all *Com-Techs* are rated for 4 to 8 ohms in Dual mode, 8 to 16 ohms in Bridge-Mono mode, and 2 to 4 ohms in Parallel-Mono mode. With 70 volt output, rated loads vary among the different models for each dual/mono mode (see the power matrices that follow).

Required AC Mains: All units draws 90 watts or less at idle. See Section 7 for detailed information on AC power draw, current draw and thermal dissipation.

Low-Voltage Power Supply: ± 15 VDC regulated supplies are provided by a winding on the AC mains power transformer.

Power Cord: An appropriate AC line cord is provided with a minimum cable length of 5 feet (see Section 2).

Controls

Enable: A front panel rocker switch used to turn the amplifier on and off.

Level: A detented 22-position back panel level control for each channel.

Output Mode: A back panel switch for each channel used to select 8/4 ohm or 70 volt output.

Dual/Mono: A three-position back panel switch used to select Dual, Bridge-Mono or Parallel-Mono operation.

Reset: A back panel push button used to reset the amplifier's AC mains breaker.

Sensitivity: A three-position switch inside the *P.I.P.* compartment used to select an input sensitivity for both channels: 0.775 volts for standard 1 kHz power in 8/4 ohm mode, 0.775 volts for standard 1 kHz power in 70 volt mode, or a voltage gain of 26 dB (see Section 4.4).

Indicators

Enable: This amber indicator shows the on/off status of the unit's low-voltage power supply.

Signal Presence (SPI): Each channel has a green indicator that flashes to show audio output.

IOC: Each channel has a yellow indicator that flashes if the output waveform differs from the input waveform by 0.05% or more. The LEDs act as sensitive distortion indicators to provide *proof of distortion-free performance*. In Parallel-Mono mode, the channel 2 *IOC* indicator stays on.

ODEP: Each channel has a green multifunction indicator that shows the channel's reserve energy status. Normally, the LEDs are brightly lit to show that reserve energy is available. In the rare event that a channel has no reserve, its indicator will dim in proportion to *ODEP* limiting. An *ODEP* indicator may also turn off under other more unusual circumstances (see Section 4.2).

Input/Output

Input Connector: A barrier block on the standard *P.I.P.*-*BB* with three-terminal balanced connections for input to each channel.

Input Impedance: Nominally 20 K ohms, balanced. Nominally 10 K ohms, unbalanced.

Input Sensitivity: Settings include 0.775 volts for 8/4 ohm output, 0.775 volts for 70 volt output, and a voltage gain of 26 dB.

Output Connector: A back panel barrier block with two-

terminal connections for each output channel.

Output Impedance: Less than 10 milliohms in series with less than 2 microhenries (see Figure 6.11).

DC Output Offset: Less than ± 10 millivolts.

Output Signal

Dual: Unbalanced, two-channel.

Bridge-Mono: Balanced, single-channel. Channel 1 controls are active; channel 2 should be turned down.

Parallel-Mono: Unbalanced, single-channel. Channel 1 controls are active; channel 2 is bypassed.

Protection

Com-Tech amplifiers are protected against shorted, open or mismatched loads; overloaded power supplies; excessive temperature, chain destruction phenomena, input overload damage and high-frequency blow-ups. They also protect loudspeakers from input/output DC and turn-on/turn-off transients.

If unreasonable operating conditions occur, the patented *ODEP* circuitry will proportionally limit the drive level to protect the output devices, particularly in the case of elevated temperature. Transformer overheating will result in a temporary shutdown of both channels; when it has cooled to a safe temperature, the transformer will automatically reset itself. Controlled slew rate voltage amplifiers protect against RF burn-outs, and input overload protection is provided by current-limiting resistance at the input.

Turn On: The four second turn-on delay prevents dangerous turn-on transients. Turn-on occurs at zero crossing of the AC waveform, so power sequencers are rarely needed with multiple units. *Note: The turn-on delay time may be changed. Contact Crown's Technical Support Group for details.*

Circuit Breaker: Circuit breaker current ratings vary based on the *Com-Tech* model and AC mains voltage.

All 100/120 VAC Units:

Com-Tech 200: 8 amperes.

Com-Tech 400: 15 amperes.

Com-Tech 800: 20 amperes.

Com-Tech 1600: 30 amperes.

All 220/240 VAC Units:

Com-Tech 200: 4 amperes.

Com-Tech 400: 8 amperes.

Com-Tech 800: 10 amperes.

Com-Tech 1600: 20 amperes.

Construction

Durable black finish on the steel chassis, front panel Lexan overlay, and specially-designed flow-through ventilation from front to side panels.

Cooling: Internal heat sinks with on-demand forced air cooling (fan is optional for the North American *Com-Tech 200*; see Sections 3.2.1 and 8.2).

Dimensions: 19 inch (48.3 cm) standard rack mount width (EIA RS-310-B), 16 inch (40.6 cm) depth behind mounting surface, and 0.25 inches (0.6 cm) in front of mounting surface. Amplifier height varies among the available models and with different AC mains voltage requirements (see Section 3.1).

Approximate Weight: Center of gravity is 6 inches (15.2 cm) behind the front mounting surface.

120 VAC, 60 Hz North American Units:

Com-Tech 200: 29 pounds, 7 ounces (13.4 kg) net; 33 pounds, 14 ounces (15.4 kg) shipping weight.

Com-Tech 400: 31 pounds, 15 ounces (14.5 kg) net; 36 pounds, 6 ounces (16.5 kg) shipping weight.

Com-Tech 800: 47 pounds, 4 ounces (21.5 kg) net; 50 pounds, 8 ounces (22.9 kg) shipping weight.

Com-Tech 1600: 57 pounds, 14 ounces (26.3 kg) net; 66 pounds, 10 ounces (30.2 kg) shipping weight.

100/120 VAC, 50/60 Hz Units:

Com-Tech 200: 31 pounds, 6 ounces (14.2 kg) net; 35 pounds, 8 ounces (16.1 kg) shipping weight.

Com-Tech 400: 38 pounds, 15 ounces (17.7 kg) net; 43 pounds, 4 ounces (19.6 kg) shipping weight.

Com-Tech 800: 45 pounds, 1 ounce (20.5 kg) net; 49 pounds, 10 ounces (22.5 kg) shipping weight.

Com-Tech 1600: 54 pounds, 11 ounces (24.8 kg) net; 64 pounds, 3 ounces (29.1 kg) shipping weight.

220/240 VAC, 50/60 Hz Units:

Com-Tech 200: 31 pounds, 12 ounces (14.4 kg) net; 35 pounds, 14 ounces (16.3 kg) shipping weight.

Com-Tech 400: 38 pounds, 7 ounces (17.5 kg) net; 42 pounds, 12 ounces (19.4 kg) shipping weight.

Com-Tech 800: 45 pounds, 4 ounces (20.5 kg) net; 49 pounds, 13 ounces (22.6 kg) shipping weight.

Com-Tech 1600: 55 pounds, 2 ounces (25.0 kg) net; 64 pounds, 10 ounces (29.3 kg) shipping weight.

*Crown specifications are **guaranteed** for three years.*

In an effort to provide you with as much information as possible about the high power-producing capabilities of your amplifier, we have created the following power matrices.

Minimum Guaranteed Power Specifications

Crown’s minimum power specifications represent the absolute smallest amount of output power you can expect from your amplifier when it is driven to full output under the given conditions. Some spaces in each matrix may be left blank because the same guarantee is not provided for those conditions—however, your amplifier will perform well under all conditions listed in each matrix.

When measuring power, 0.1% THD appears to be the industry standard for distortion. Two of the maximum average power specifications shown in each minimum power matrix are measured at 0.1% THD so you can easily compare Crown specifications to those of other manufacturers. But this high level of distortion actually allows for some clipping which is undesirable. Because of this, a maximum average power specification at 0.05% THD is included in each minimum power matrix which represents non-clipped conditions. Although most manufacturers do not give you power specifications at 0.05% THD, we encourage them to provide these specifications so you will have a more realistic representation of the way amplifiers should be used in the real world—without a clipped output signal.

Many manufacturers publish power specs with a tolerance of ± 1 dB or worse. This means their amplifier can deviate more than 20% in output! A 100 watt amplifier would meet their specification if it only produced 79.4 watts. Other manufacturers qualify their specs by saying they are “typical,” “subject to manufacturing tolerances,” “single channel driven” or that they are specified with “fuses bypassed.” Each of these statements effectively removes any performance guarantee. In fact, some manufacturers use these tactics to generate large power numbers, and they don’t even print a disclaimer. We take a different approach at Crown—our amplifiers are *guaranteed* to meet or exceed their specifications for three years. Further, because our published specs are set below our “in-house” measurements, you can expect every Crown amplifier to exceed its published minimum power specs. We believe you should get what you pay for.

Com-Tech 200 – Minimum Guaranteed Power (Watts)							
AC Mains	Dual/Mono Mode	Load in Ohms (Constant Voltage)	Maximum Average			FTC Continuous Average	
			At 0.1% THD (See note 1)	At 0.1% THD (See note 2)	At 0.05% THD (See note 3)	At 0.1% THD (See note 4)	
			1 kHz	20Hz-20kHz	1 kHz	1 kHz	20Hz-20kHz
120 VAC, 60 Hz	Dual (both channels driven)	4	150	135	145	140	125
		8	110	105	105	105	100
		50 (70V)	110	105	110	110	105
	Bridge-Mono (balanced output)	8	300	270	295	270	250
		16	220	210	215	210	205
		100 (140V)	205	200	205	205	200
	Parallel-Mono	2	295		290	275	
		4	215		210	215	
		25 (70V)	210		205	205	
100/120 VAC, 50/60 Hz	Dual (both channels driven)	4	145	135	145	135	125
		8	110	105	110	110	105
		50 (70V)	105	95	105	100	95
	Bridge-Mono (balanced output)	8	290	265	285	275	250
		16	220	210	220	215	205
		100 (140V)	205	195	205	205	190
	Parallel-Mono	2	290		285	270	
		4	215		210	210	
		25 (70V)	210		205	205	
220/240 VAC, 50/60 Hz	Dual (both channels driven)	4	150	140	150	140	130
		8	115	110	115	110	105
		50 (70V)	105	100	105	105	95
	Bridge-Mono (balanced output)	8	300	275	295	280	260
		16	230	220	225	225	215
		100 (140V)	215	200	210	210	195
	Parallel-Mono	2	300		300	275	
		4	225		225	220	
		25 (70V)	215		215	210	

their specs by saying they are “typical,” “subject to manufacturing tolerances,” “single channel driven” or that they are specified with “fuses bypassed.” Each of these statements effectively removes any performance guarantee. In fact, some manufacturers use these tactics to generate large power numbers, and they don’t even print a disclaimer. We take a different approach at Crown—our amplifiers are *guaranteed* to meet or exceed their specifications for three years. Further, because our published specs are set below our “in-house” measurements, you can expect every Crown amplifier to exceed its published minimum power specs. We believe you should get what you pay for.

Minimum Power Notes:

All minimum power specifications are based on 0.5% regulated AC mains with THD of less than 1.0% and an ambient room temperature of 70° F (21° C). Standard EIA power (RS-490) is not shown here because it is identical to FTC Continuous Average Power.

1. A 1 kHz sine wave is presented to the amplifier and the output monitored for nonlinear distortion. The level is increased until THD reaches 0.1%. At this point, average power per channel is reported.
2. A sine wave is presented to the amplifier over the range from 20 Hz to 20 kHz and the output monitored for nonlinear distortion. The level at each frequency is increased until THD reaches 0.1%. At this point, average power per channel is reported.
3. A 1 kHz sine wave is presented to the amplifier and the output monitored for nonlinear distortion. The level is increased until THD reaches 0.05%. At this point, average power per channel is reported.
4. Continuous power in the context of Federal Trade Commission testing is understood to be a minimum of five minutes of operation. Harmonic distortion is measured as the RMS sum total and given as a percentage of the fundamental output voltage. This applies for all wattages greater than 0.25 watts.

Fig. 6.1 Com-Tech 200 Minimum Power Matrix

Com-Tech 400 – Minimum Guaranteed Power (Watts)							
AC Mains	Dual/Mono Mode	Load in Ohms (Constant Voltage)	Maximum Average			FTC Continuous Average	
			At 0.1% THD (See note 1)	At 0.1% THD (See note 2)	At 0.05% THD (See note 3)	At 0.1% THD (See note 4)	
			1 kHz	20Hz-20kHz	1 kHz	1 kHz	20Hz-20kHz
120 VAC, 60 Hz	Dual (both channels driven)	4	240	215	235	225	200
		8	220	210	220	215	205
		25 (70V)	225	215	225	215	205
	Bridge-Mono (balanced output)	8	475	425	465	440	405
		16	450	425	440	430	405
		50 (140V)	455	435	450	435	415
	Parallel-Mono	2	440		430	415	
		4	440		440	425	
		12.5 (70V)	455		450	440	
100/120 VAC, 50/60 Hz	Dual (both channels driven)	4	240	215	235	225	200
		8	220	205	215	215	200
		25 (70V)	225	220	225	220	210
	Bridge-Mono (balanced output)	8	465	415	455	430	380
		16	435	410	435	430	405
		50 (140V)	455	435	450	440	415
	Parallel-Mono	2	450		445	420	
		4	445		445	435	
		12.5 (70V)	455		450	440	
220/240 VAC, 50/60 Hz	Dual (both channels driven)	4	240	215	240	225	200
		8	220	210	220	215	205
		25 (70V)	225	220	225	220	215
	Bridge-Mono (balanced output)	8	465	415	455	435	390
		16	445	420	440	435	410
		50 (140V)	460	440	455	445	430
	Parallel-Mono	2	430		425	405	
		4	435		430	430	
		12.5 (70V)	455		455	450	

Fig. 6.2 Com-Tech 400 Minimum Power Matrix

Com-Tech 800 – Minimum Guaranteed Power (Watts)							
AC Mains	Dual/Mono Mode	Load in Ohms (Constant Voltage)	Maximum Average			FTC Continuous Average	
			At 0.1% THD (See note 1)	At 0.1% THD (See note 2)	At 0.05% THD (See note 3)	At 0.1% THD (See note 4)	
			1 kHz	20Hz-20kHz	1 kHz	1 kHz	20Hz-20kHz
120 VAC, 60 Hz	Dual (both channels driven)	4	490	460	480	470	455
		8	305	295	300	300	290
		12.5 (70V)	460	455	455	450	445
	Bridge-Mono (balanced output)	8	975	935	965	950	905
		16	610	600	605	605	600
		25 (140V)	920	905	905	905	880
	Parallel-Mono	2	965		950	950	
		4	610		600	605	
		6.25 (70V)	915		905	910	
100/120 VAC, 50/60 Hz	Dual (both channels driven)	4	460	440	460	445	425
		8	300	290	295	295	290
		12.5 (70V)	425	415	420	410	400
	Bridge-Mono (balanced output)	8	925	885	915	890	840
		16	600	580	595	595	575
		25 (140V)	855	825	850	830	800
	Parallel-Mono	2	925		920	895	
		4	600		595	595	
		6.25 (70V)	855		845	830	
220/240 VAC, 50/60 Hz	Dual (both channels driven)	4	485	470	485	465	450
		8	310	305	310	310	300
		12.5 (70V)	440	430	435	425	420
	Bridge-Mono (balanced output)	8	965	920	955	930	875
		16	620	605	615	615	600
		25 (140V)	885	855	875	865	840
	Parallel-Mono	2	940		930	920	
		4	615		610	600	
		6.25 (70V)	875		870	855	

Fig. 6.3 Com-Tech 800 Minimum Power Matrix

Com-Tech 1600 – Minimum Guaranteed Power (Watts)							
AC Mains	Dual/Mono Mode	Load in Ohms (Constant Voltage)	Maximum Average			FTC Continuous Average	
			At 0.1% THD (See note 1)	At 0.1% THD (See note 2)	At 0.05% THD (See note 3)	At 0.1% THD (See note 4)	
			1 kHz	20Hz-20kHz	1 kHz	1 kHz	20Hz-20kHz
120 VAC, 60 Hz	Dual (both channels driven)	4	870	810	860	850	
		8	540	520	535	540	510
		6.25 (70V)	960	910	955	960	
	Bridge-Mono (balanced output)	8	1,745	1,595	1,725	1,700	
		16	1,080	1,040	1,070	1,075	1,040
		12.5 (140V)	1,805	1,725	1,795	1,770	
	Parallel-Mono	2	1,745		1,720	1,690	
		4	1,080		1,070	1,075	
		3.13 (70V)	1,780		1,760	1,745	
100/120 VAC, 50/60 Hz	Dual (both channels driven)	4	815	775	805		
		8	535	515	530	530	510
		6.25 (70V)	860	830	850	815	
	Bridge-Mono (balanced output)	8	1,625	1,545	1,615		
		16	1,070	1,035	1,060	1,055	1,020
		12.5 (140V)	1,700	1,640	1,695	1,625	
	Parallel-Mono	2	1,660		1,640		
		4	1,080		1,070	1,060	
		3.13 (70V)	1,700		1,690	1,620	
220/240 VAC, 50/60 Hz	Dual (both channels driven)	4	840	785	840		
		8	545	525	540	540	505
		6.25 (70V)	875	755	870	850	
	Bridge-Mono (balanced output)	8	1,675	1,550	1,665		
		16	1,090	910	1,075	1,070	900
		12.5 (140V)	1,755	1,315	1,745	1,710	
	Parallel-Mono	2	1,650		1,635		
		4	1,075		1,065	1,065	
		3.13 (70V)	1,745		1,735	1,715	

Fig. 6.4 Com-Tech 1600 Minimum Power Matrix

Maximum Power Specifications

Crown's maximum power specifications represent the largest amount of output power you can expect from your amplifier when it is driven to full output under the given conditions. These specifications can be used to prevent loudspeaker and hearing damage.

The maximum power matrices include specifications for single cycle and 40 millisecond burst sine waves. Burst signals act like large transient peaks that are present in common source signals. Loudspeakers can respond to a single cycle burst, so the single cycle burst specifications should be used to help you protect your loudspeakers. In contrast, a 40 millisecond burst represents the typical response time of the human ear. Your ear will not respond to the entire dynamic change of a burst that lasts less than 40 milliseconds.

The burst power specifications are provided at 0.05% THD which is a practical low distortion condition. Operating the amplifier at levels higher than 0.05% THD can result in output power levels that are higher than those listed in the maximum power matrices.

Com-Tech 200 – Maximum Power (Watts)									
AC Mains	Dual/Mono Mode	Load in Ohms (Constant Voltage)	Single Cycle Tone Burst At less than 0.05% THD (See note 1)				40 Millisecond Tone Burst At 0.05% THD (See note 2)		
			20 Hz	50 Hz	1 kHz	7 kHz	50 Hz	1 kHz	7 kHz
120 VAC, 60 Hz	Dual (both channels driven)	4	170	205	275	275	175	155	165
		8	130	145	165	165	130	115	120
		50 (70V)	130	135	140	135	130	125	130
	Bridge-Mono (balanced output)	8	355	400	535	530	345	310	325
		16	255	280	325	320	250	225	240
		100 (140V)	255	270	275	265	255	250	255
	Parallel-Mono	2	345	405	520	520	345	300	315
		4	255	280	315	315	245	220	230
		25 (70V)	255	270	280	265	255	245	255
100/120 VAC, 50/60 Hz	Dual (both channels driven)	4	165	220	310	305	190	165	175
		8	125	155	185	180	135	125	130
		50 (70V)	140	150	150	145	140	135	140
	Bridge-Mono (balanced output)	8	325	435	600	605	380	325	345
		16	250	300	360	360	265	245	255
		100 (140V)	275	295	305	290	275	265	275
	Parallel-Mono	2	325	425	580	585	360	310	335
		4	245	305	355	355	265	235	250
		25 (70V)	275	295	305	290	275	265	275
220/240 VAC, 50/60 Hz	Dual (both channels driven)	4	165	225	315	310	190	165	175
		8	130	155	185	185	140	125	130
		50 (70V)	140	150	155	150	140	135	140
	Bridge-Mono (balanced output)	8	330	440	625	625	375	325	345
		16	250	310	370	370	270	245	260
		100 (140V)	305	310	315	300	310	310	300
	Parallel-Mono	2	315	425	595	590	370	315	335
		4	250	305	365	360	270	240	255
		25 (70V)	280	295	305	295	280	270	280

Maximum Power Notes:

All maximum power specifications are based on 0.5% regulated AC mains with THD of less than 1.0% and an ambient room temperature of 70° F (21° C). Although it is an unusual condition, your amplifier can function well with AC mains voltages up to 10% over the specified line voltage. With overvoltage conditions, your amplifier may be capable of delivering instantaneous power levels up to 20% greater than the specifications in the matrix.

1. A single cycle sine wave is presented to the amplifier and monitored for nonlinear distortion. The average power during the burst is reported. Loudspeakers must be able to withstand this level if they are to be safely used with this amplifier.
2. A 40 millisecond sine wave burst (10 percent duty cycle) is presented to the amplifier and monitored for nonlinear distortion. Average power during the burst is reported. This power level is a measurement of the amplifier's maximum transient power that can be perceived by the human ear.

Fig. 6.5 Com-Tech 200 Maximum Power Matrix

Com-Tech 400 – Maximum Power (Watts)									
AC Mains	Dual/Mono Mode	Load in Ohms (Constant Voltage)	Single Cycle Tone Burst At less than 0.05% THD (See note 1)				40 Millisecond Tone Burst At 0.05% THD (See note 2)		
			20 Hz	50 Hz	1 kHz	7 kHz	50 Hz	1 kHz	7 kHz
			120 VAC, 60 Hz	Dual (both channels driven)	4	320	415	460	450
8	265	300			360	355	260	235	250
25 (70V)	305	330			340	330	305	290	305
Bridge-Mono (balanced output)	8	620		820	875	855	695	620	645
	16	520		600	720	705	510	475	490
	50 (140V)	590		655	675	655	600	575	595
Parallel-Mono	2	615		805	825	810	685	615	645
	4	505		595	715	700	515	470	490
	12.5 (70V)	595		650	680	655	600	575	695
100/120 VAC, 50/60 Hz	Dual (both channels driven)	4	315	415	555	550	360	315	330
		8	240	285	330	325	255	230	240
		25 (70V)	280	310	325	315	285	270	280
	Bridge-Mono (balanced output)	8	620	820	1,110	1,095	725	620	655
		16	475	570	665	660	500	455	480
		50 (140V)	555	615	645	630	565	540	565
	Parallel-Mono	2	610	790	1,080	1,070	710	605	635
		4	470	560	655	640	495	450	470
		12.5 (70V)	550	615	645	620	565	535	560
220/240 VAC, 50/60 Hz	Dual (both channels driven)	4	315	405	435	435	360	310	330
		8	240	285	335	325	250	230	240
		25 (70V)	280	315	325	315	290	275	285
	Bridge-Mono (balanced output)	8	625	820	860	865	725	625	650
		16	475	575	665	655	500	455	480
		50 (140V)	665	675	680	650	675	675	650
	Parallel-Mono	2	605	745	745	745	700	600	625
		4	465	565	645	640	490	445	465
		12.5 (70V)	550	610	645	620	565	535	555

Fig. 6.6 Com-Tech 400 Maximum Power Matrix

Com-Tech 800 – Maximum Power (Watts)									
AC Mains	Dual/Mono Mode	Load in Ohms (Constant Voltage)	Single Cycle Tone Burst At less than 0.05% THD (See note 1)				40 Millisecond Tone Burst At 0.05% THD (See note 2)		
			20 Hz	50 Hz	1 kHz	7 kHz	50 Hz	1 kHz	7 kHz
			120 VAC, 60 Hz	Dual (both channels driven)	4	515	575	695	690
8	320	340			385	375	320	300	310
12.5 (70V)	480	530			590	575	480	455	475
Bridge-Mono (balanced output)	8	1,010		1,120	1,405	1,385	1,060	945	995
	16	640		680	770	755	650	595	620
	25 (140V)	980		1,045	1,185	1,145	960	910	955
Parallel-Mono	2	1,060		1,160	1,390	1,380	1,100	950	985
	4	645		685	765	755	650	590	615
	6.25 (70V)	975		1,045	1,170	1,135	985	910	945
100/120 VAC, 50/60 Hz	Dual (both channels driven)	4	460	605	750	730	555	470	490
		8	230	295	375	370	275	235	245
		12.5 (70V)	475	545	610	595	510	470	490
	Bridge-Mono (balanced output)	8	915	1,195	1,500	1,480	1,110	935	980
		16	600	705	810	790	665	600	630
		25 (140V)	920	1,085	1,230	1,190	990	910	955
	Parallel-Mono	2	900	1,195	1,485	1,450	1,075	920	960
		4	600	700	805	780	660	600	625
		6.25 (70V)	915	1,070	1,210	1,185	975	905	945
220/240 VAC, 50/60 Hz	Dual (both channels driven)	4	475	610	755	740	570	485	500
		8	305	360	405	395	340	305	320
		12.5 (70V)	475	545	615	590	505	475	490
	Bridge-Mono (balanced output)	8	930	1,190	1,530	1,470	1,095	945	985
		16	605	705	815	785	675	605	635
		25 (140V)	920	1,085	1,225	1,180	980	910	945
	Parallel-Mono	2	910	1,185	1,475	1,415	1,085	920	955
		4	600	710	790	770	665	595	620
		6.25 (70V)	915	1,080	1,225	1,175	985	910	940

Fig. 6.7 Com-Tech 800 Maximum Power Matrix

Com-Tech 1600 – Maximum Power (Watts)									
AC Mains	Dual/Mono Mode	Load in Ohms (Constant Voltage)	Single Cycle Tone Burst At less than 0.05% THD (See note 1)				40 Millisecond Tone Burst At 0.05% THD (See note 2)		
			20 Hz	50 Hz	1 kHz	7 kHz	50 Hz	1 kHz	7 kHz
			120 VAC, 60 Hz	Dual (both channels driven)	4	780	1,000	1,245	1,215
8	525	600			670	655	555	525	545
6.25 (70V)	950	1,035			1,205	1,170	925	875	905
Bridge-Mono (balanced output)	8	1,600		1,995	2,480	2,420	1,875	1,670	1,745
	16	1,050		1,185	1,330	1,285	1,145	1,050	1,090
	12.5 (140V)	1,770		1,980	2,315	2,225	1,785	1,675	1,735
Parallel-Mono	2	1,590		1,985	2,465	2,390	1,830	1,665	1,715
	4	1,140		1,170	1,330	1,300	1,130	1,045	1,080
	3.13 (70V)	1,895		2,015	2,375	2,280	1,880	1,715	1,780
100/120 VAC, 50/60 Hz	Dual (both channels driven)	4	820	1,060	1,370	1,335	1,005	835	870
		8	555	655	750	720	610	550	570
		6.25 (70V)	955	1,100	1,295	1,255	1,025	895	930
	Bridge-Mono (balanced output)	8	1,635	2,095	2,700	2,680	1,930	1,650	1,735
		16	1,090	1,285	1,475	1,440	1,200	1,080	1,130
		12.5 (140V)	1,895	2,165	2,550	2,490	1,985	1,760	1,825
	Parallel-Mono	2	1,640	2,105	2,715	2,630	1,955	1,655	1,725
		4	1,090	1,300	1,470	1,425	1,195	1,080	1,120
		3.13 (70V)	1,845	2,110	2,530	2,430	1,965	1,745	1,810
220/240 VAC, 50/60 Hz	Dual (both channels driven)	4	800	1,060	1,295	1,245	955	820	850
		8	535	630	700	685	590	530	550
		6.25 (70V)	885	1,025	1,210	1,165	960	845	875
	Bridge-Mono (balanced output)	8	1,600	2,060	2,580	2,520	1,915	1,630	1,695
		16	1,055	1,225	1,410	1,365	1,155	1,050	1,095
		12.5 (140V)	1,800	2,115	2,475	2,395	1,935	1,720	1,800
	Parallel-Mono	2	1,615	2,100	2,585	2,525	1,920	1,635	1,700
		4	1,065	1,230	1,415	1,380	1,175	1,055	1,095
		3.13 (70V)	1,855	2,080	2,450	2,315	1,940	1,720	1,785

Fig. 6.8 Com-Tech 1600 Maximum Power Matrix

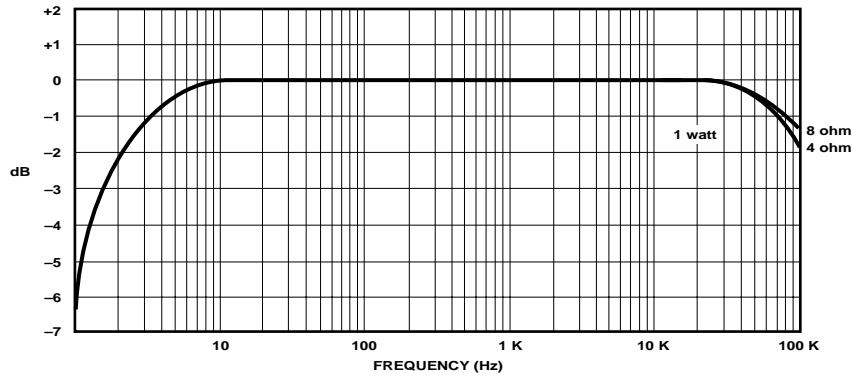

Fig. 6.9 Typical Frequency Response

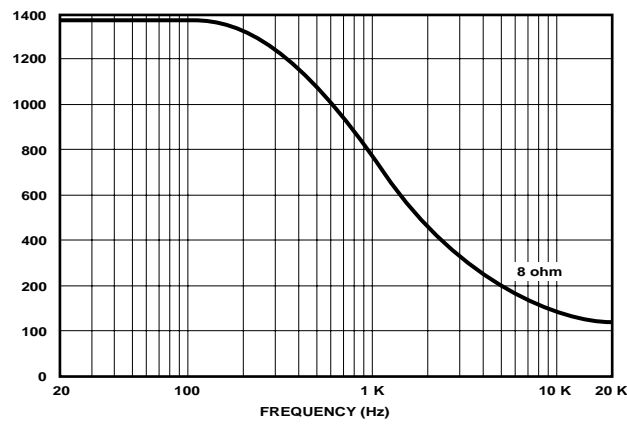

Fig. 6.10 Typical Damping Factor

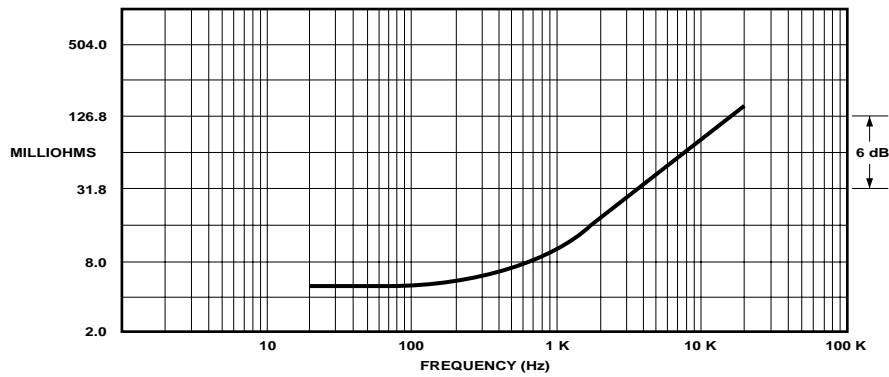

Fig. 6.11 Typical Output Impedance

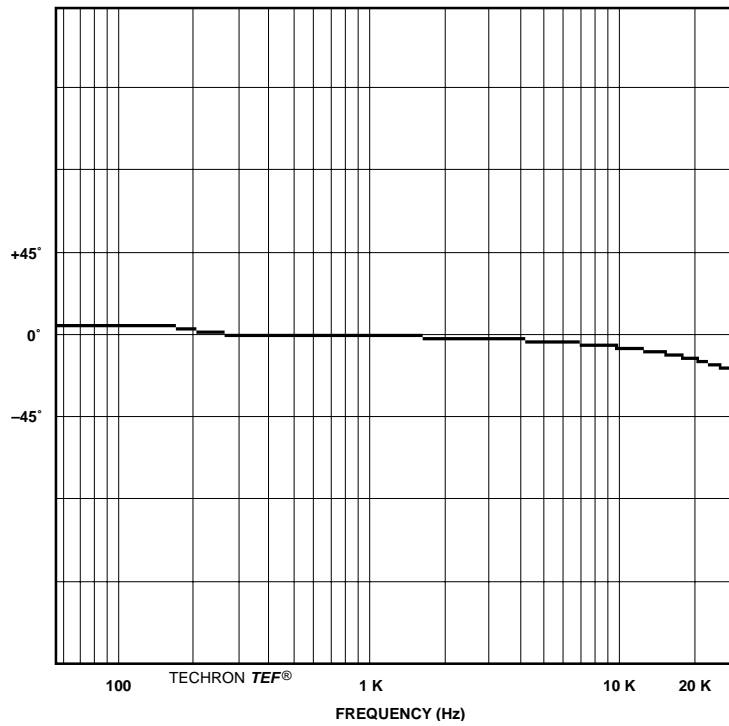

Fig. 6.12 Typical Phase Response

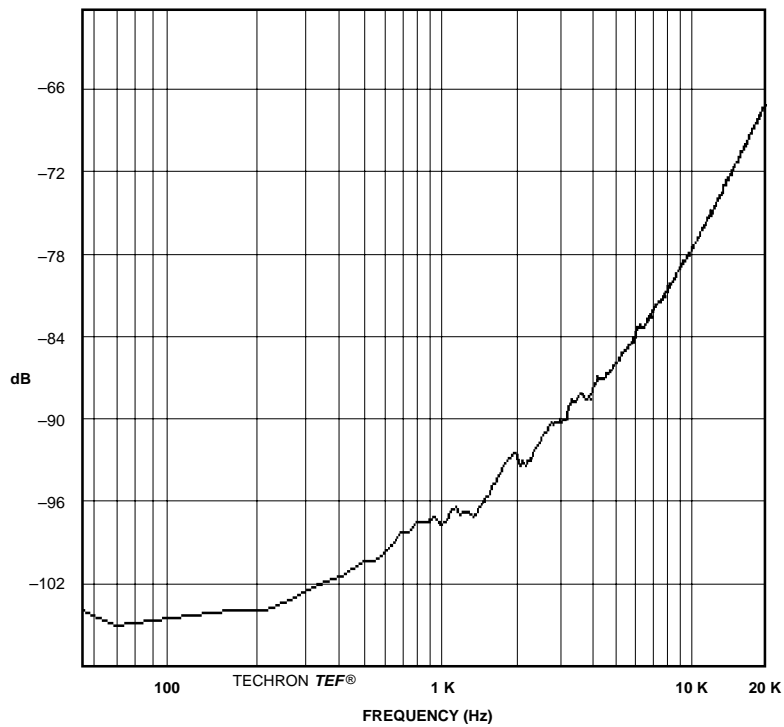

Fig. 6.13 Typical Crosstalk

7 AC Power Draw and Thermal Dissipation

This section provides detailed information about the amount of power and current drawn from the AC mains by *Com-Tech* amplifiers and the amount of heat produced under various conditions. The calculations presented here are intended to provide a realistic and reliable depiction of the amplifiers. The following assumptions or approximations were made:

- The amplifier's available channels are loaded, and full power is being delivered.
- Amplifier efficiency at standard 1 kHz power is estimated to be 65%.
- In 8/4 ohm mode, typical quiescent power draw is 20 watts for the *Com-Tech 200*, 30 watts for the *Com-Tech 400*, 55 watts for the *Com-Tech 800* and 70 watts for the *Com-Tech 1600*.
- In 70 volt mode, typical quiescent power draw is 30 watts for the *Com-Tech 200*, 35 watts for the *Com-Tech 400*, and 90 watts for the *Com-Tech 800* and *1600*.
- When running at full speed, typical power draw for the internal fan is 11 watts for the *Com-Tech 200*, *400* and *800*, and 17 watts for the *Com-Tech 1600* (the fan is an option for the *Com-Tech 200*).
- Quiescent thermal dissipation is related .
- The estimated duty cycles take into account the typical crest factor for each type of source material.
- Duty cycle of pink noise is 50%.
- Duty cycle of highly compressed rock 'n' roll midrange is 40%.
- Duty cycle of rock 'n' roll is 30%.
- Duty cycle of background music is 20%.

- Duty cycle of continuous speech is 10%.
- Duty cycle of infrequent paging is 1%.

Here are the equations used to calculate the data presented in Figures 7.1 through 7.4:

$$\text{AC Mains Power Draw (watts)} = \frac{\text{Total output power with all channels driven (watts)} \times \text{Duty Cycle}}{\text{Amplifier Efficiency (.65)}} + \text{Quiescent Power Draw (watts)}$$

The value used for quiescent power draw includes both the amplifier's quiescent power draw for the selected output mode and the power drawn by the fan if one is installed (these values are listed in the previous column). The following equation converts power draw in watts to current draw in amperes:

$$\text{Current Draw (amperes)} = \frac{\text{AC Mains Power Draw (watts)}}{\text{AC Mains Voltage} \times \text{Power Factor (.83)}}$$

The power factor of 0.83 is needed to compensate for the difference in phase between the AC mains voltage and current. The following equation is used to calculate thermal dissipation:

$$\text{Thermal Dissipation (btu/hr)} = \left(\frac{\text{Total output power with all channels driven (watts)} \times \text{Duty Cycle} \times .35}{\text{Amplifier Efficiency (.65)}} + \text{Quiescent Power Draw (watts)} \right) \times 3.415$$

The constant 0.35 is inefficiency (1.00 - 0.65) and the factor 3.415 converts watts to btu/hr. Thermal dissipation in btu is divided by the constant 3.968 to get kcal. If you plan to measure output power under real-world conditions, the following equation may also be helpful:

$$\text{Thermal Dissipation (btu/hr)} = \left(\frac{\text{Total measured output power from all channels (watts)} \times .35}{\text{Amplifier Efficiency (.65)}} + \text{Quiescent Power Draw (watts)} \right) \times 3.415$$

Com-Tech 200

Duty Cycle	L O A D														
	8 Ohm Dual / 16 Ohm Bridge-Mono / 4 Ohm Parallel-Mono						4 Ohm Dual / 8 Ohm Bridge-Mono / 2 Ohm Parallel-Mono				70 V				
	AC Mains Power Draw (Watts)	Current Draw (Amps)		Thermal Dissipation		AC Mains Power Draw (Watts)	Current Draw (Amps)		Thermal Dissipation		AC Mains Power Draw (Watts)	Current Draw (Amps)		Thermal Dissipation	
		100-120 V	220-240 V	btu/hr	kcal/hr		100-120 V	220-240 V	btu/hr	kcal/hr		100-120 V	220-240 V	btu/hr	kcal/hr
50%	200	2.4	1.1	305	80	265	3.1	1.4	380	95	210	2.5	1.1	340	85
40%	165	2.0	0.9	265	70	215	2.6	1.2	325	85	175	2.1	1.0	300	75
30%	135	1.6	0.7	225	60	170	2.0	0.9	270	70	145	1.7	0.8	260	65
20%	100	1.2	0.5	185	50	125	1.5	0.7	215	55	110	1.3	0.6	220	55
10%	65	0.8	0.3	145	40	80	0.9	0.4	160	40	75	0.9	0.4	180	45

Fig. 7.1 *Com-Tech 200* Power Draw, Current Draw and Thermal Dissipation at Various Duty Cycles

Com-Tech 400

Duty Cycle	L O A D														
	8 Ohm Dual / 16 Ohm Bridge-Mono / 4 Ohm Parallel-Mono					4 Ohm Dual / 8 Ohm Bridge-Mono / 2 Ohm Parallel-Mono					70 V				
	AC Mains Power Draw (Watts)	Current Draw (Amps)		Thermal Dissipation		AC Mains Power Draw (Watts)	Current Draw (Amps)		Thermal Dissipation		AC Mains Power Draw (Watts)	Current Draw (Amps)		Thermal Dissipation	
100-120 V		220-240 V	btu/hr	kcal/hr	100-120 V		220-240 V	btu/hr	kcal/hr	100-120 V		220-240 V	btu/hr	kcal/hr	
50%	390	4.7	2.1	550	140	410	4.9	2.2	580	150	395	4.8	2.2	575	145
40%	320	3.8	1.7	470	120	335	4.0	1.8	490	125	325	3.9	1.8	490	125
30%	250	3.0	1.4	385	100	265	3.2	1.4	400	100	255	3.1	1.4	405	105
20%	180	2.2	1.0	305	80	190	2.3	1.0	315	80	185	2.2	1.0	320	80
10%	110	1.3	0.6	220	55	115	1.4	0.6	225	60	115	1.4	0.6	240	60

Fig. 7.2 Com-Tech 400 Power Draw, Current Draw and Thermal Dissipation at Various Duty Cycles

Com-Tech 800

Duty Cycle	L O A D														
	8 Ohm Dual / 16 Ohm Bridge-Mono / 4 Ohm Parallel-Mono					4 Ohm Dual / 8 Ohm Bridge-Mono / 2 Ohm Parallel-Mono					70 V				
	AC Mains Power Draw (Watts)	Current Draw (Amps)		Thermal Dissipation		AC Mains Power Draw (Watts)	Current Draw (Amps)		Thermal Dissipation		AC Mains Power Draw (Watts)	Current Draw (Amps)		Thermal Dissipation	
100-120 V		220-240 V	btu/hr	kcal/hr	100-120 V		220-240 V	btu/hr	kcal/hr	100-120 V		220-240 V	btu/hr	kcal/hr	
50%	535	6.4	2.9	785	200	820	9.9	4.5	1125	285	810	9.7	4.4	1190	300
40%	440	5.3	2.4	670	170	670	8.0	3.7	945	240	670	8.0	3.6	1020	260
30%	350	4.2	1.9	560	140	520	6.2	2.8	765	195	525	6.3	2.9	850	215
20%	255	3.0	1.4	450	115	370	4.4	2.0	585	150	385	4.6	2.1	680	170
10%	160	1.9	0.9	335	85	220	2.6	1.2	405	100	245	2.9	1.3	510	130

Fig. 7.3 Com-Tech 800 Power Draw, Current Draw and Thermal Dissipation at Various Duty Cycles

Com-Tech 1600

Duty Cycle	L O A D														
	8 Ohm Dual / 16 Ohm Bridge-Mono / 4 Ohm Parallel-Mono					4 Ohm Dual / 8 Ohm Bridge-Mono / 2 Ohm Parallel-Mono					70 V				
	AC Mains Power Draw (Watts)	Current Draw (Amps)		Thermal Dissipation		AC Mains Power Draw (Watts)	Current Draw (Amps)		Thermal Dissipation		AC Mains Power Draw (Watts)	Current Draw (Amps)		Thermal Dissipation	
100-120 V		220-240 V	btu/hr	kcal/hr	100-120 V		220-240 V	btu/hr	kcal/hr	100-120 V		220-240 V	btu/hr	kcal/hr	
50%	920	11.1	5.0	1300	330	1435	17.3	7.8	1915	485	1590	19.1	8.7	2140	540
40%	755	9.1	4.1	1100	280	1165	14.0	6.4	1590	400	1295	15.6	7.1	1790	450
30%	590	7.1	3.2	905	230	895	10.8	4.9	1270	320	1000	12.0	5.5	1435	365
20%	425	5.1	2.3	705	180	630	7.6	3.4	950	240	700	8.4	3.8	1085	275
10%	260	3.1	1.4	510	130	360	4.3	2.0	630	160	405	4.9	2.2	730	185

Fig. 7.4 Com-Tech 1600 Power Draw, Current Draw and Thermal Dissipation at Various Duty Cycles

Note: In Fire Protective Signaling Systems, the Com-Tech 200 may use the P.I.P.-BB, P.I.P.-ISO or P.I.P.-UL1711, however the Com-Tech 400, 800 and 1600 may only use the P.I.P.-UL1711.

8 Accessories

8.1 P.I.P. Modules

One advantage of Com-Tech amplifiers is the ability to customize them using P.I.P. (Programmable Input Processor) modules. Com-Tech amplifiers are equipped with an edge card connector inside the back panel P.I.P. compartment. The modules install easily:

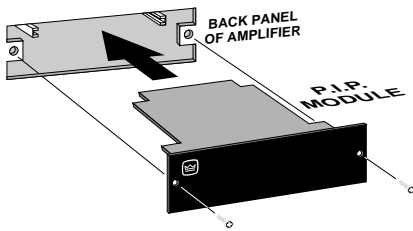
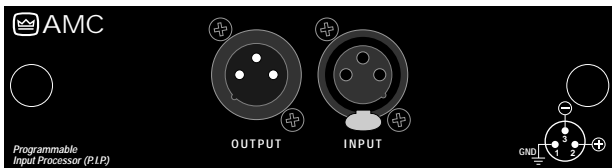

Fig. 8.1 Installing a P.I.P. Module

WARNING: Disconnect power to the amplifier when installing or removing a P.I.P. module.

Here are some of the available P.I.P. modules:



P.I.P.-AMCb unites many features of the P.I.P.-XOV and P.I.P.-CLP. It offers a variable 4th-order Linkwitz-Riley crossover and an *IOC*-driven, variable threshold compressor. In addition, it provides “constant-directivity” horn equalization and filter-assisted B_6 vented box equalization. Biamping and triamping capabilities are provided via XLR connectors.

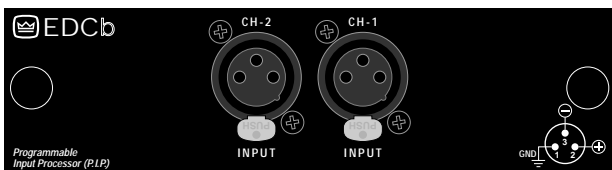

P.I.P.-EDCb combines a sophisticated error-driven compressor and smooth limiter with a subsonic filter for each channel. The compressors have adjustable attack and release times, and can be set to track each other. The compressors activate when a signal will clip the input, an *IOC* error occurs, or the output exceeds the selected threshold. The subsonic filters have corner frequencies of 24, 28, 32 and 36 Hz.

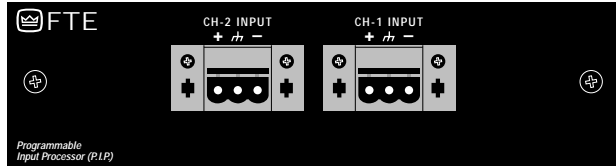

P.I.P.-FTE includes all P.I.P.-FXT features, and adds 12 dB/octave RFI filters, variable 18 dB/octave high-pass filters, and 6 dB/octave 3 kHz shelving networks for “constant-directivity” horn equalization. Screw terminal plugs are provided for input.



IQ-P.I.P. v1.3 integrates the amplifier into Crown's patented *IQ System*.[®] The *IQ System* provides centralized computer control of 1 to 2,000 amplifiers. Each amplifier channel can be monitored and controlled from an inexpensive personal computer. Any combination of mic- and line-level signals can also be mixed and routed with optional *MPX-6*,[™] *SMX-6*[™] and *AMB-5*[™] mixer/multiplexers, and the MRX series matrixers.

IQ-P.I.P. v1.4 *Smart Amp*[™] offers the monitoring and control features of the IQ-P.I.P. v1.3 plus the capability to function as a stand-alone unit as part of the *IQ System's distributed intelligence*.[™] Features include a smooth output limiter for transparent loudspeaker protection, power supply gates for energy savings, *ODEP* conservation which protects the output devices with precision input signal control, interrupt-driven reporting that lets you define error conditions, and configurable short detection.

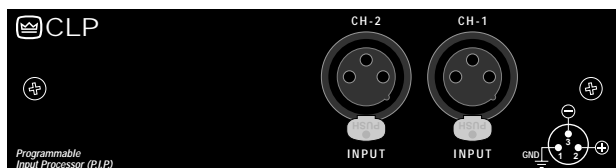

P.I.P.-CLP is designed to detect and prevent overload. Its compressor is driven by the amplifier's built-in *IOC* error detection circuitry. Unlike typical signal-driven compressors, it only compresses the signal to prevent overload. It can deliver up to 13 dB of additional headroom without being noticeable.

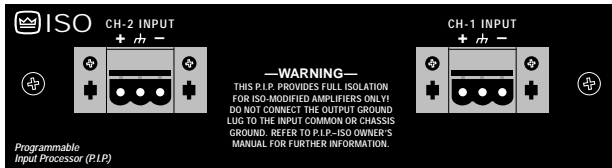

P.I.P.-ISO is designed especially for 25 to 140 volt distributed systems where UL[®]-listed isolation is required. Installation requires minor amplifier modifications. With the P.I.P.-ISO installed, the amplifier outputs are safely isolated from the input terminals and the chassis.

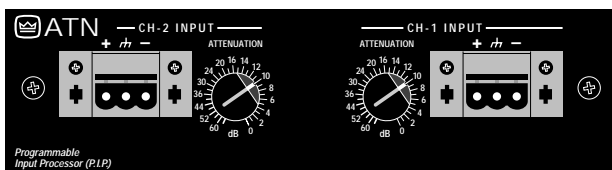

P.I.P.-ATN includes all P.I.P.-FTE features, plus a 32-step precision attenuator for each channel.

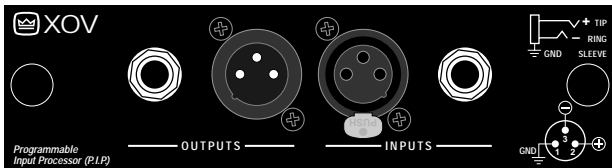

P.I.P.-XOV is a versatile 18 dB/octave mono crossover/ filter with blamping and triamping capabilities.

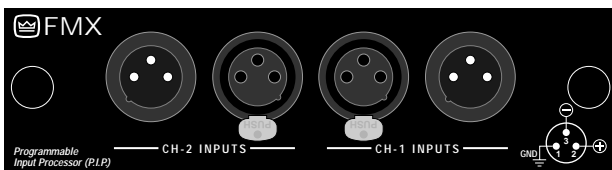

P.I.P.-FMX facilitates "daisy-chaining" balanced amplifier inputs. Female to male three-pin XLR connectors are used to passively bridge the inputs.

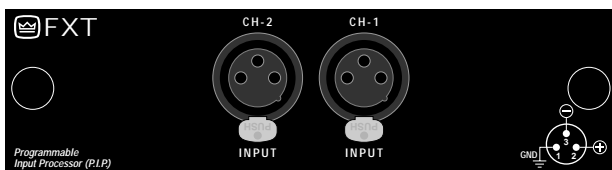

P.I.P.-FXT uses balanced 1:1 transformers to isolate the amplifier from the input signal. It has balanced female three-pin XLR connectors.

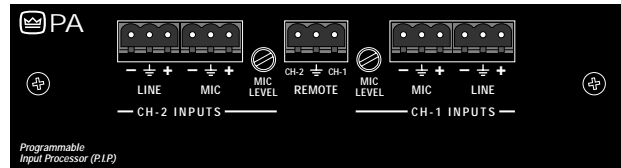

P.I.P.-PA adds a switchable balanced low-impedance mic input, a balanced line-level input and a compressor to each channel. Remote switching circuitry provides quick and quiet fades from mic to line and back.

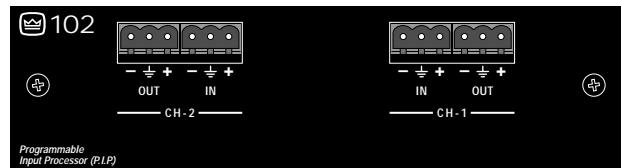

P.I.P.-102 is a two-channel module providing equalization based on the BOSE[®] 102 controller. Screw terminal plugs provide balanced connections. Each input channel has an output from the P.I.P. that can be independently configured for output with no processing, 102 equalization or 102 equalization with bass-cut.

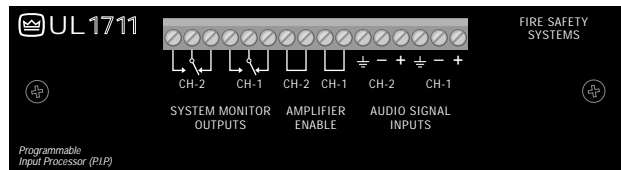

P.I.P.-UL1711 provides full compliance for Com-Techs in UL-listed fire protective signaling applications (see Section 9). Includes monitoring and remote on/off.

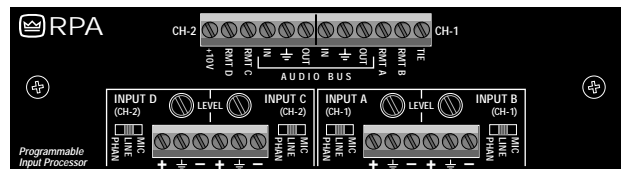

P.I.P.-RPA adds the features of a 4x2 mixer to your amplifier. Its four inputs accept mic- or line-level input. It offers priority switching ("voice-over") of each input and remote level control with the RPA-RMT. Other features include bus inputs and outputs, adjustable input sensitivity, phantom power and RFI suppression. Input isolation transformers are optional.

For more information on these or other P.I.P.s under development, contact your local dealer or Crown's Technical Support Group.

8.2 Com-Tech 200 Cooling Fan

A three-speed cooling fan (part GCT200FAN) is available for North American *Com-Tech 200s* (all other units include a fan). We strongly recommend the kit if you will be operating a *Com-Tech 200* at high levels or in high temperatures for long periods (see Section 3.2.1).



CAUTION: Because the installation of this fan involves the risk of electric shock, it should **ONLY** be attempted by a qualified technician.

Each cooling fan kit contains the following parts:

- Fan motor (H42934-2)
- Fan blade (C 9939-7)
- Mounting bracket (F11106-6 or D 8439-8)
- 2 phillips flat head 6-32 machine screws (C 7062-0)
- 2 torx head 6-32 machine screws (A10110-70605)

Installation is not difficult, but you should be sure the unit's power cord is unplugged before beginning.

1. Turn off the amplifier and disconnect its power cord from the AC power receptacle.
2. Remove the top cover of the amplifier. Use a phillips screwdriver to remove the two screws that secure it to the back panel. Gently pry the back of the cover up and away from the chassis, then pull the front up and back to unhook it.



WARNING: The power supply capacitors are very large and can cause shock. Always discharge them before working in close proximity.

3. Locate the two large power supply capacitors on

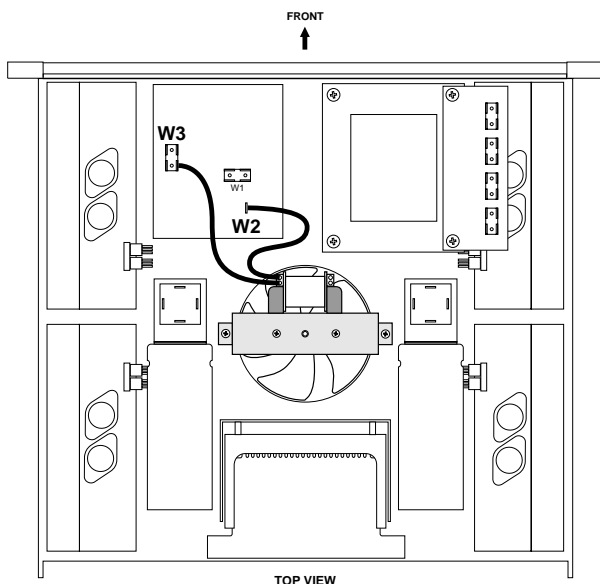

Fig. 8.2 Cooling Fan Option

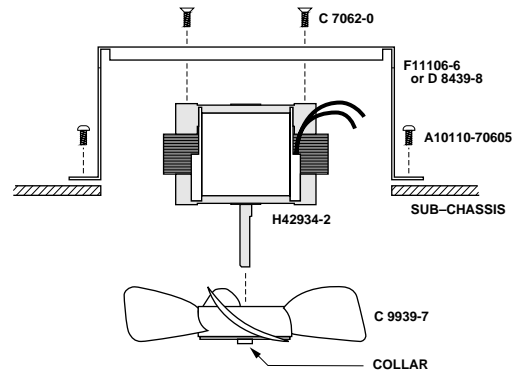

Fig. 8.3 Cooling Fan Assembly

either side of the *P.I.P.* compartment. Safely discharge them by placing a 100 ohm, 10 watt resistor across the + and - terminals of each capacitor. Use caution: **DO NOT TOUCH** the discharge resistor—it can become quite hot. (Use pliers to hold the resistor while you discharge the capacitors.)

4. Attach the fan motor to its bracket using the two flat head screws supplied in the kit (Figure 8.3). A phillips screwdriver is required.
5. Push the fan blade on the motor shaft until the shaft end is flush with the collar (Figure 8.3). The fan blades should be positioned so the collar faces away from the fan motor.
6. Attach the fan assembly to the subchassis (Figures 8.2 and 8.3) with the two torx head screws supplied in the kit (a torx nut driver is required). The fan motor assembly should be positioned with the wires facing the front of the amplifier.
7. Connect a wire from the fan motor to jumper block W3 and the remaining wire to W2 as shown in Figure 8.2. (It doesn't matter which wire goes to which location because the fan uses an AC motor.)
8. Replace the cover and reconnect power.

8.3 Constant Voltage Computer

Crown's constant voltage computer is a easy-to-use slide rule for audio applications. The first scale finds the impedance of a step-down transformer based on delivered power and the transformer's rated voltage. This scale also identifies the proper transformer tap to use when a particular constant voltage rating is not provided with the transformer (such as 25, 35, 50, 70, 100 or 140 volts). Other scales include line loss, parallel resistance, dB-SPL vs. distance and dB-SPL vs. power. To get your own constant voltage computer, call Crown's Technical Support Group and ask for literature.

9 Fire Protective Signaling

Some installations are required to have an emergency public address system. For these systems, UL provides a special listing called Amplifiers for Fire Protective Signaling Systems. All *Com-Tech* amplifiers are UL-listed for this type of system.

Due to the strenuous nature of the classification, several requirements must be considered for proper installation:

1. The amplifier must be installed in a 19 inch rack mount enclosure that is UL-listed for use in Fire Protective Signaling Systems.
2. The amplifier must be installed in the same room as the Fire Alarm Control Unit.
3. The amplifier must be installed in accordance with the *National Electric Code* (NFPA 70), the *National Fire Alarm Code* (NFPA 72) and the local authority having jurisdiction.
4. The *Com-Tech 200* must have a *P.I.P.-BB*, a *P.I.P.-UL1711* or a *P.I.P.-ISO* installed (see Section 8.1). All other *Com-Tech* amplifiers must have a *P.I.P.-UL1711* installed for supervision by a UL-listed Fire Alarm Control Unit.
5. The amplifier must be configured for 70 volt Dual mode operation.
6. The power requirement of the connected loudspeakers should not exceed the amplifier's power rating for Fire Protective Signaling Systems (refer to the specification that follows).

When using a *Com-Tech 200* in a Fire Protective Signaling Application, *UL* does not require the installation of a *P.I.P.-UL1711* as they do for the other *Com-Tech* amplifiers. Even so, the *P.I.P.-UL1711* might still be a desirable addition with its amplifier monitoring and remote on/off capabilities. With a *Com-Tech 200*, if a *P.I.P.-UL1711* is not installed, either the included

P.I.P.-BB or a *P.I.P.-ISO* must be installed. No matter which *P.I.P.* is installed, the input wiring must be supervised by the Fire Alarm Control Unit. Please refer to Section 3.3.2 for *P.I.P.-BB* wiring instructions. For *P.I.P.-UL1711* and *P.I.P.-ISO* installation, please refer to the wiring instructions provided in each *P.I.P.* manual.

For Fire Protective Signaling Applications, *UL* requires an amplifier's output power ratings to be valid for emergency operating conditions. This is why *Com-Tech* amplifiers have special 70 volt Dual mode power specifications for Fire Protective Signaling Applications. The *Com-Tech 200* is rated for 50 watts per channel, the *Com-Tech 400* is rated for 122 watts per channel, the *Com-Tech 800* is rated for 222 watts per channel, and the *Com-Tech 1600* is rated for 350 watts per channel. All models have a power bandwidth for this specification of 800 to 2,800 Hz. Crown guarantees these specification in accordance with the elevated operating temperature and strenuous conditions associated with emergency operation.

Current draw from the AC mains is also rated specifically for Fire Protective Signaling Applications. The *Com-Tech 200* has a rating of 3.0 amps, the *Com-Tech 400* has a rating of 6.0 amps, the *Com-Tech 800* has a rating of 9.0 amps, and the *Com-Tech 1600* has a rating of 18.0 amps.

UL installation guidelines do not allow an amplifier to exceed its power rating for Fire Protective Signaling Applications. *Com-Tech* amplifiers can deliver much more power than this special rating suggests, so you must ensure that the total of the wattage ratings for the connected loudspeakers does not exceed the amplifier's required power rating for *UL* listing.

The specifications provided in this section supersede those given in Section 6 only for Fire Protective Signaling Applications. For more information on using *Com-Tech* amplifiers in Fire Protective Signaling Applications, please refer to the *P.I.P.-UL1711 Owner's Manual* or contact Crown's Technical Support Group.

10 Service

This unit has very sophisticated circuitry which should only be serviced by a fully trained technician. This is one reason why each unit bears the following label:



CAUTION: To prevent electric shock, do not remove covers. No user serviceable parts inside. Refer servicing to a qualified technician.

10.1 Worldwide Service

Service may be obtained from an authorized service center. (Contact your local Crown/Amcron representative or our office for a list of authorized service centers.) To obtain service, simply present the bill of sale as proof of purchase along with the defective unit to an authorized service center. They will handle the necessary paperwork and repair.

Remember to transport your unit in the original factory pack. We will pay the surface shipping costs both ways **for warranty service** to the authorized service center nearest you after receiving copies of all shipping receipts. You must bear the expense of all taxes, duties, and customs fees when transporting the unit.

10.2 North American Service

Service may be obtained in one of two ways: from an authorized service center or from the factory. You may choose either. It is important that you have your copy of the bill of sale as your proof of purchase.

10.2.1 Service at a North American Service Center

This method usually saves the most time and effort. Simply present your bill of sale along with the defective unit to an authorized service center to obtain service. They will handle the necessary paperwork and repair. Remember to transport the unit in the original factory pack. A list of authorized service centers in your area can be obtained from our Technical Support Group.

10.2.2 Factory Service

To obtain factory service, fill out the **service information page** that follows and send it along with your proof of purchase and the defective unit to the Crown factory. For warranty service, we will pay for ground shipping both ways in the United States after receiving copies of the shipping receipts. Shipments should be sent "UPS ground." (If the unit is under warranty, you may send it C.O.D. for the cost of freight via UPS ground.) The factory will return it via UPS ground. Please contact us if other arrangements are required.

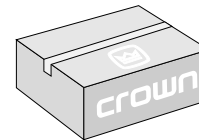

Always use the original factory pack to transport the unit.

Factory Service Shipping Instructions:

1. When sending a Crown product to the factory for service, be sure to fill out the service information form that follows and enclose it inside your unit's shipping pack. Do not send the service information form separately.
2. To ensure the safe transportation of your unit to the factory, ship it in an original factory packing container. If you don't have one, call or write Crown's Parts Department. With the exception of polyurethane or wooden crates, any other packing material will not be sufficient to withstand the stress of shipping. **Do not use loose, small size packing materials.**
3. Do not ship the unit in any kind of cabinet (wood or metal). Ignoring this warning may result in extensive damage to the unit and the cabinet. Accessories are not needed—do not send the instruction manual, cables and other hardware.

If you have any questions, please call or write the Crown Technical Support Group.

Crown Audio Division

Tech. Support/Factory Service
57620 C.R. 105
Elkhart, Indiana 46517 U.S.A.

Phone: 1-219-294-8200
Fax: 1-219-294-8301

Toll Free in Canada, Puerto Rico, the United States & Virgin Islands: 1-800-342-6939

