



CROWN

INSTRUCTION MANUAL

SERIAL NO. _____

ISSUED TO _____

D-60

**DUAL-CHANNEL
POWER AMPLIFIER**



1945

THE UNITED STATES OF AMERICA

DEPARTMENT OF THE ARMY

OFFICE OF THE CHIEF OF STAFF

MEMORANDUM

TO: THE CHIEF OF STAFF

FROM: THE CHIEF OF STAFF

DESCRIPTION**1.1 GENERAL**

FIG. 1 - 1
INTEGRATED CIRCUIT STEREO
D-60 AMPLIFIER

The D-60 is a dual-channel medium power amplifier for ultra-low distortion amplification from 5Hz to 20KHz with operation into loads of 4 ohms and higher. The unit features extremely low harmonic and intermodulation distortion, very low noise, highest "damping factor," and quality parts and workmanship. The unit may be wired to produce a balanced 25 volt monaural output. The amplifier is fully protected against mismatched and shorted loads by a resetting V-I (volt-ampere) limiter having no obnoxious muting or program delays.

The power supply features large computer-grade filter capacitors.

A total of 24 discrete transistors, 1 linear IC (dual op amp), 14 diodes and 1 bridge rectifier are utilized in a CROWN-pioneered Class AB+B output circuit. The effective number of semiconductors is 40 transistors and 24 diodes.

The input voltage-amplifiers, (IC), are powered by two voltage-regulated supplies. This results in complete channel-to-channel isolation and independence from line voltage variations.

Two level controls are mounted on the front panel to allow balancing and optimizing of system levels.

1.2 SPECIFICATIONS

1.2.1 STEREO SPECIFICATIONS

Output Power	35 watts per channel minimum RMS (both channels operating) into an 8 ohm load over a bandwidth of 20Hz-20KHz at a rated RMS sum total harmonic distortion of 0.05% of the fundamental output voltage.
Frequency Response	$\pm 0.1\text{dB}$ 20Hz-20KHz at 1 watt into 8 ohms; $\pm 1.2\text{dB}$ 5Hz-100KHz at 1 watt into 8 ohms.
1 KHz Power	40 watts RMS into 8 ohms, per channel, both channels operating, 0.1% total harmonic distortion.
Harmonic Distortion	Less than 0.001% from 20Hz-400Hz, and increasing linearly to 0.05% at 20KHz at 35 watts RMS per channel into 8 ohms.
I.M. Distortion (60Hz-7KHz 4:1)	Less than 0.05% from 0.01 watts to 0.25 watts, and less than 0.01% from 0.25 watts to 35 watts into 8 ohms per channel.
Slewing Rate	6 volts per microsecond (slewing rate is the maximum value of the first derivative of the output signal, or the maximum slope of the output signal).
Damping Factor	Greater than 400, DC-400Hz into 8 ohms.
Output Impedance	Less than 15 milliohms in series with less than 3 microhenries.
Load Impedance	Rated for 8 ohm usage; safely drives any load including completely reactive loads.
Voltage Gain	$20.6\pm 2\%$ or $26.3\pm 0.2\text{dB}$ at maximum gain.
Input Sensitivity	0.75 volts $\pm 2\%$ for 28 watts into 8 ohms.
Output Signal	Unbalanced, dual channel.

TABLE OF CONTENTS

PAGE

Section 1	DESCRIPTION	
1.1	General	1
1.2	Specifications	2,3,4,5,6,7,8,9
1.3	Warranty	10
1.4	Accessories	10
1.4.1	"R" Series Walnut Enclosures	10
1.4.2	VFX-2A	10
1.4.3	UMX-300 Transformer	10
Section 2	INSTALLATION	
2.1	Unpacking	11
2.2	Mounting	11
2.3	Normal Hi-Fi Installation	13
2.4	Connecting Output Lines	13
2.4.1	Mono Operation	14
2.5	Connecting Input Lines	15
2.6	Connecting Power	16
Section 3	OPERATING INSTRUCTIONS	
3.1	Controls and Adjustments	17
3.2	The Protection Mechanisms	17
3.3	Operating Precautions	19
3.4	Load Protection Methods	19
3.5	Cleaning	20
Section 4	CIRCUITRY	
4.1	Principles of Operation	21
4.2	Test Procedures	21
4.3	Service	22
Section 5	APPLICATION NOTES	
	Note #1 V-1 Limits of a Load	23
	Note #2 Speaker Protection	25

LIST OF ILLUSTRATIONS

TITLE		
1-1	D-60 Pictorial	1
1-2	D-60 and VFX-2A in Optional S-R Enclosure	10
1-3	UMX-300 Transformer	10
2-1	End-Cap/Bracket Mounting	11
2-2	Mounting Dimensions	11
2-3	Normal Hi-Fi Installation	12
2-4	Rear View of Chassis	13
2-5	Schematic for Full Range Electrostatic Speaker Connection	13
2-6	Source Resistance and Damping Factor vs. Length and Size of Output Leads	14
2-7	D-60 Mono Hook-up	15
2-8	Graph for Selection of Input Capacitor	15
2-9	Low-Pass Filters for Severe RF at Inputs	15
3-1	Operating Controls	17
3-2	Graph of VI Operating Range of D-60 Output	18
3-3	Fuse Selector Nomograph for Loudspeaker Protection	19
3-4	Relay-Controlled Protector with Overload Indicator	20
3-5	Turn-on-Transient Muter for Load Protection	20
	Schematic	

Handwritten header text, possibly a date or reference number.

First paragraph of handwritten text, starting with a capital letter.

Vertical handwritten notes or a list on the right margin.

Second paragraph of handwritten text.

Vertical handwritten notes on the right margin.

Third paragraph of handwritten text.

Vertical handwritten notes on the right margin.

Fourth paragraph of handwritten text.

Vertical handwritten notes on the right margin.

Fifth paragraph of handwritten text.

Vertical handwritten notes on the right margin.

Sixth paragraph of handwritten text.

Vertical handwritten notes on the right margin.

Final line of handwritten text at the bottom of the page.

Final vertical handwritten notes on the right margin.

1.2.2 MONAURAL SPECIFICATIONS

Output Power	70 watts minimum RMS into a 16 ohm load over a bandwidth of 20Hz-20KHz at a rated RMS sum total harmonic distortion of 0.05% of the fundamental output voltage.
Frequency Response	$\pm 0.2\text{dB}$ 20Hz-20KHz, 1 watt, 16 ohms. $\pm 1\text{dB}$ 6Hz-50KHz, 1 watt, 16 ohms.
1KHz Power	80 watts RMS into 16 ohms.
Harmonic Distortion	Less than 0.001% from 20Hz-400Hz and increasing linearly to 0.05% at 20KHz at 70 watts into 16 ohms.
I.M. Distortion	Less than 0.05% from 0.01 watts to 0.25 watts, and less than 0.01% from 0.25 watts to 70 watts into 16 ohms.
Slewing Rate	12 volts per microsecond.
Damping Factor	Greater than 400, DC-400Hz into 16 ohms.
Output Impedance	Less than 30 milliohms in series with less than 6 microhenries.
Load Impedance	Rated for 16 ohm usage, safely drives any load including completely reactive loads.
Voltage Gain	$41.2 \pm 2\%$ or $32.3 \pm 0.2\text{dB}$ at maximum gain.
Input Sensitivity	0.75 volts $\pm 2\%$ for 70 watts into 16 ohms.
Output Signal	Balanced, single channel.

1.2.3 GENERAL SPECIFICATIONS

Hum and Noise (20Hz-20KHz)	106dB below rated output.
Phase Response	+10, -15° 20Hz-20KHz at 1 watt.
Input Impedance	25K ohms ±30%.
Amplifier Output Protection	Short, mismatch, and open circuit proof. V-I limiting is instantaneous with no annoying thumps, cutout, etc.
Overall Protection	AC line fused. Controlled slewing rate voltage amplifiers protect overall amplifier against RF burnouts. Input overload protection is furnished by internal resistance at inputs of amp.
DC Output Offset (Shorted Input)	10 millivolts or less.
Turn-on	Instantaneous, with minimum thumps and no program delay.
Circuit	Wideband multiple feedback loop design utilizing one linear IC (dual op-amp). Total equivalent of 40 transistors, 18 signal diodes, 2 zeners, and 4 rectifier diodes.
Power Supply	Special design low profile transformer. Computer grade filter capacitors. Two regulated supplies for complete isolation and stability.
Power Requirements	Requires 50Hz-400Hz AC on 100, 120, 200, 220, or 240 volts ±10% operation. Draws 15 watts or less on idle, 120 watts at 70 watts total output.
Heat Sinking	The entire amplifier is used as a heat sink. Front panel extrusion acts as a heat sink, along with the chassis covers.
Chassis	Aluminum chassis construction for maximum heat conduction and minimum weight.
Controls	Two input level controls on front panel with power switch and pilot light. A mono-stereo switch is located next to the input jacks on the rear panel.
Connectors	Input — ¼ inch phone jack. Output — Color-coded binding posts with stereo ¼ inch earphone jack on front panel. AC Line — Three-wire (grounded) male connector on 5 foot minimum cable.
Dimensions	17 inches long, 8¾ inches deep, and 1¾ inches high (8 inches deep from mounting surface). 19 inch standard rack mounting hardware included.
Weight	10 pounds net weight
Finish	Satinized aluminum front panel with gray suede Lexan insert.

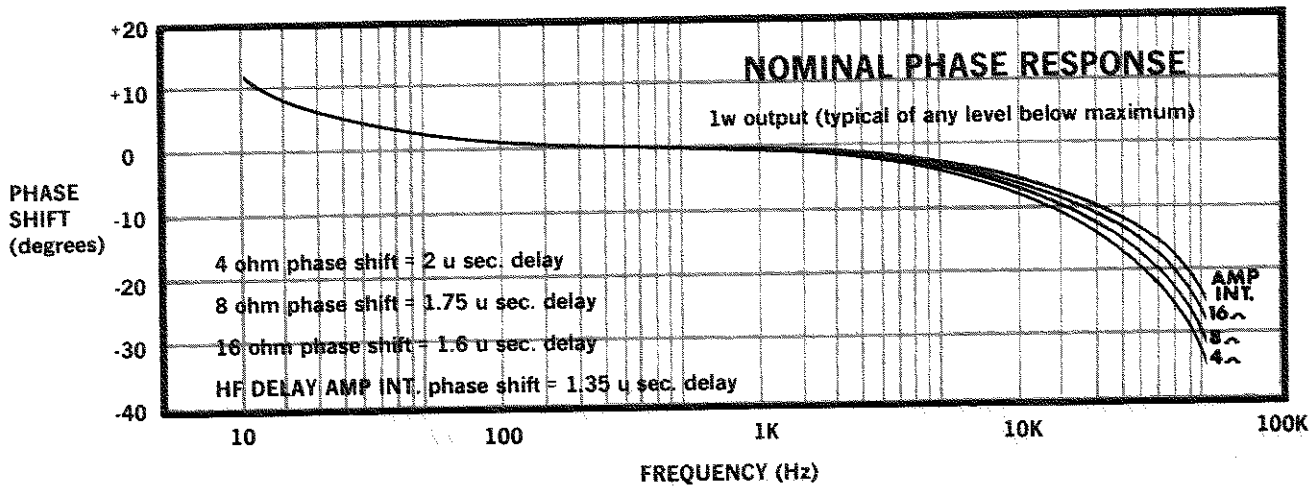
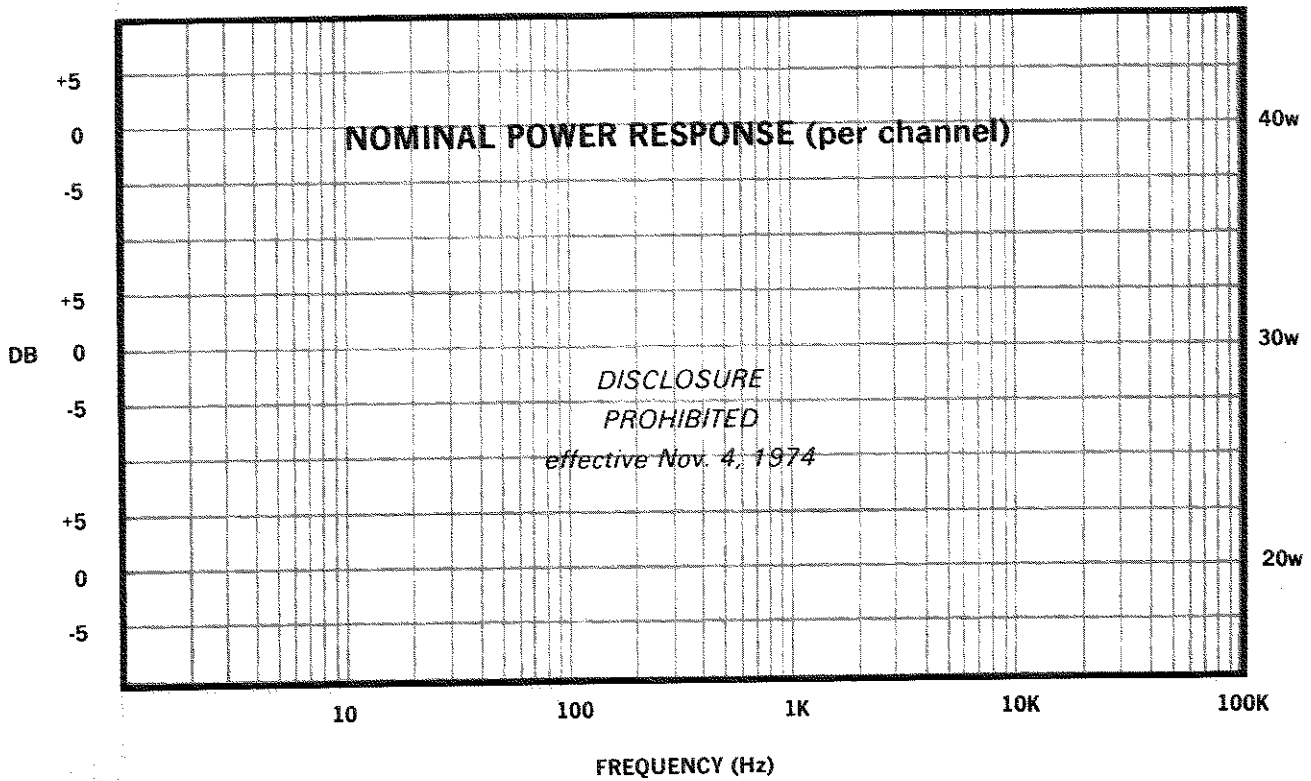
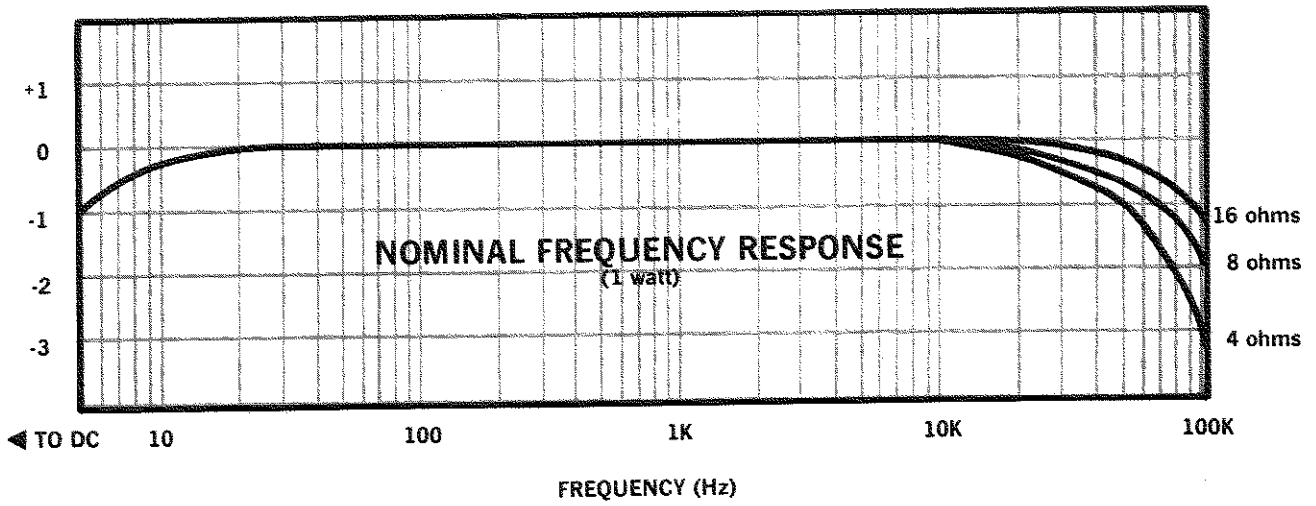

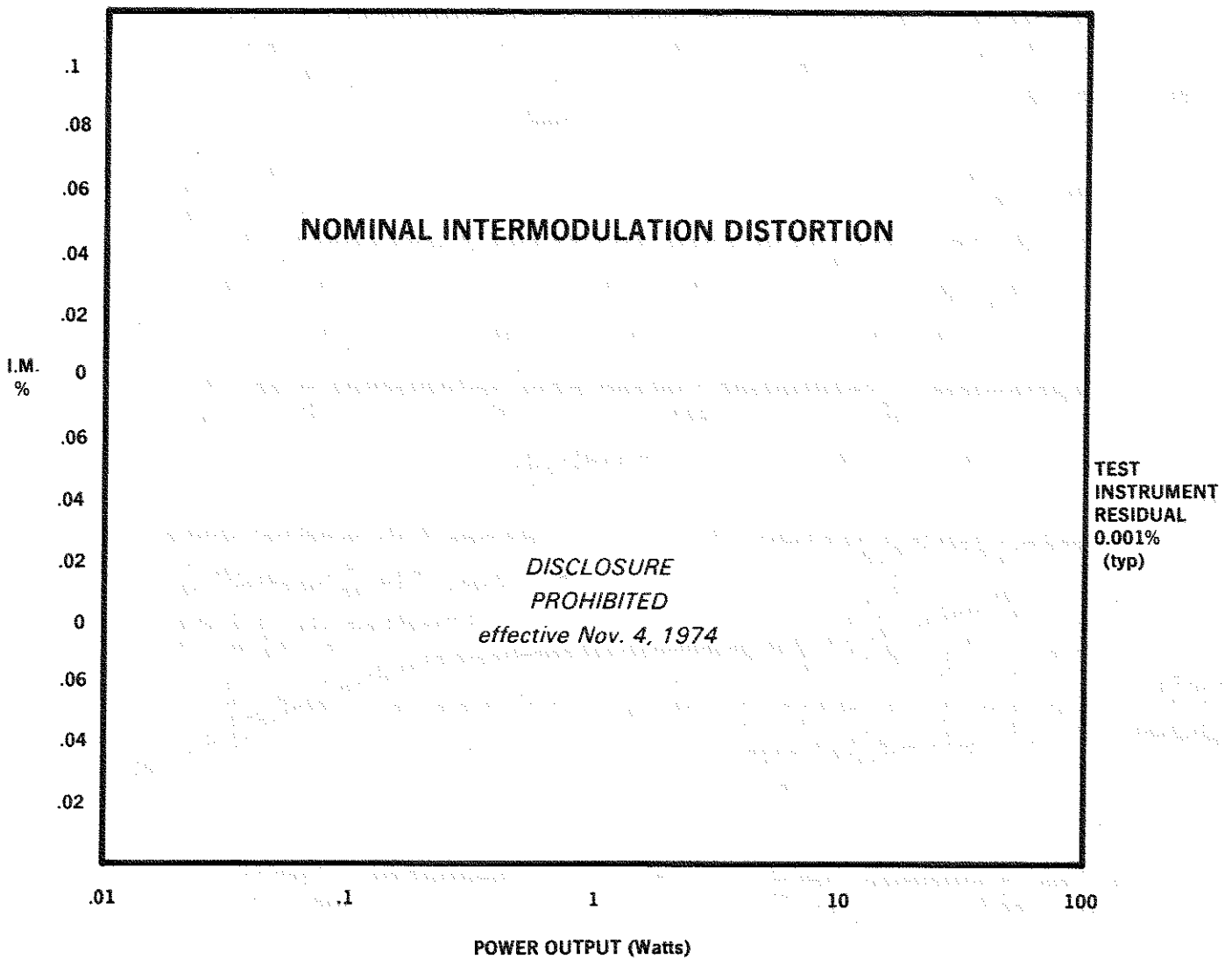
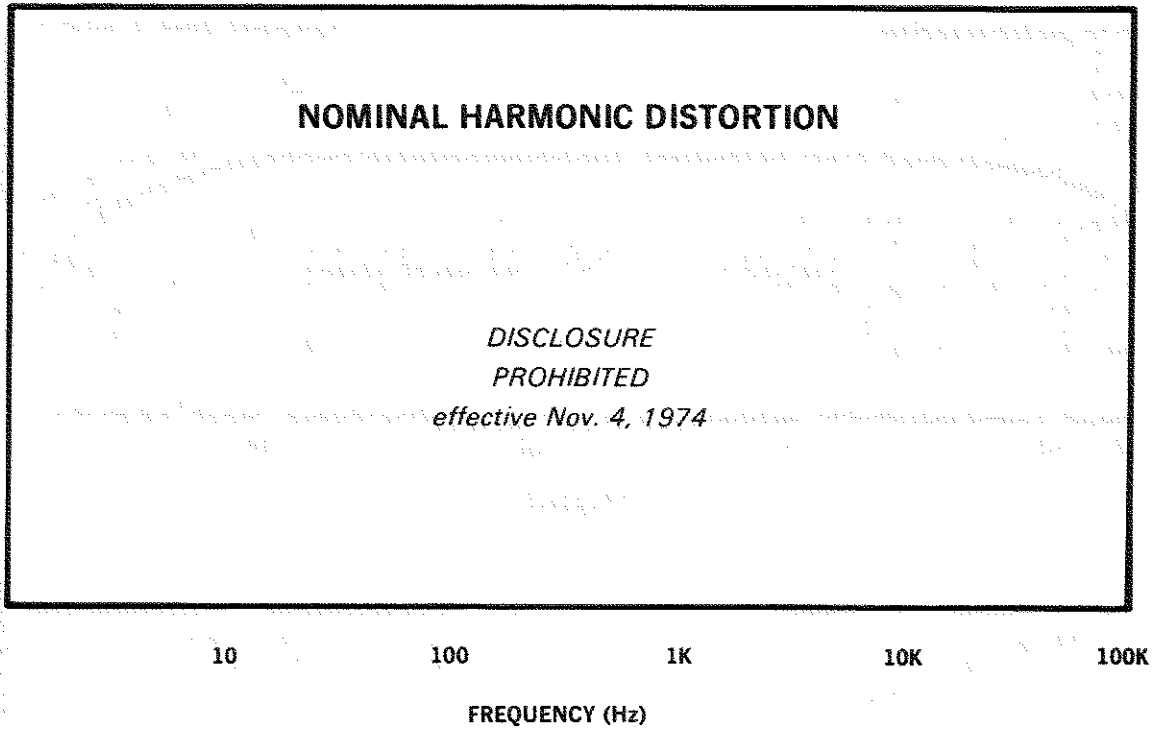

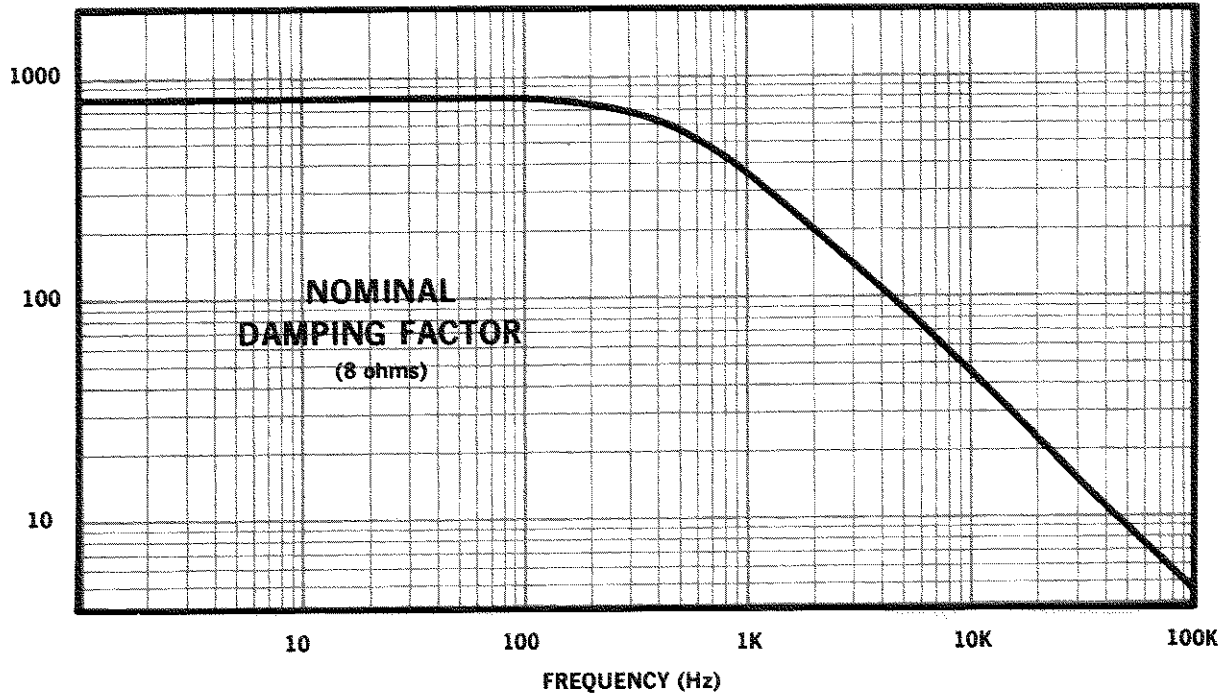
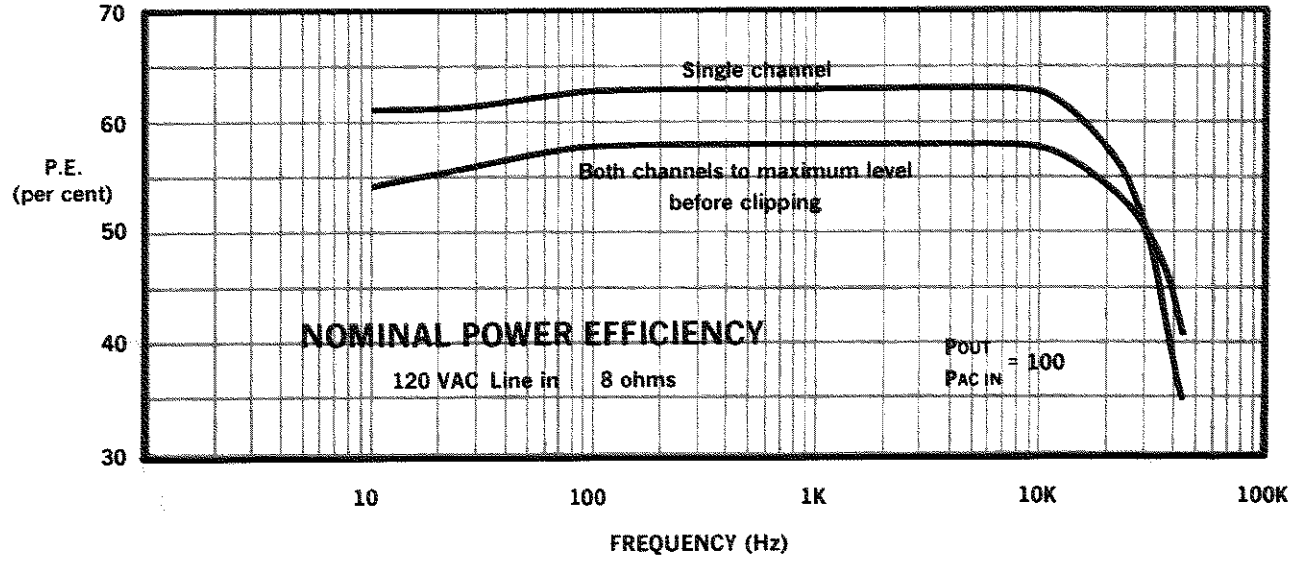
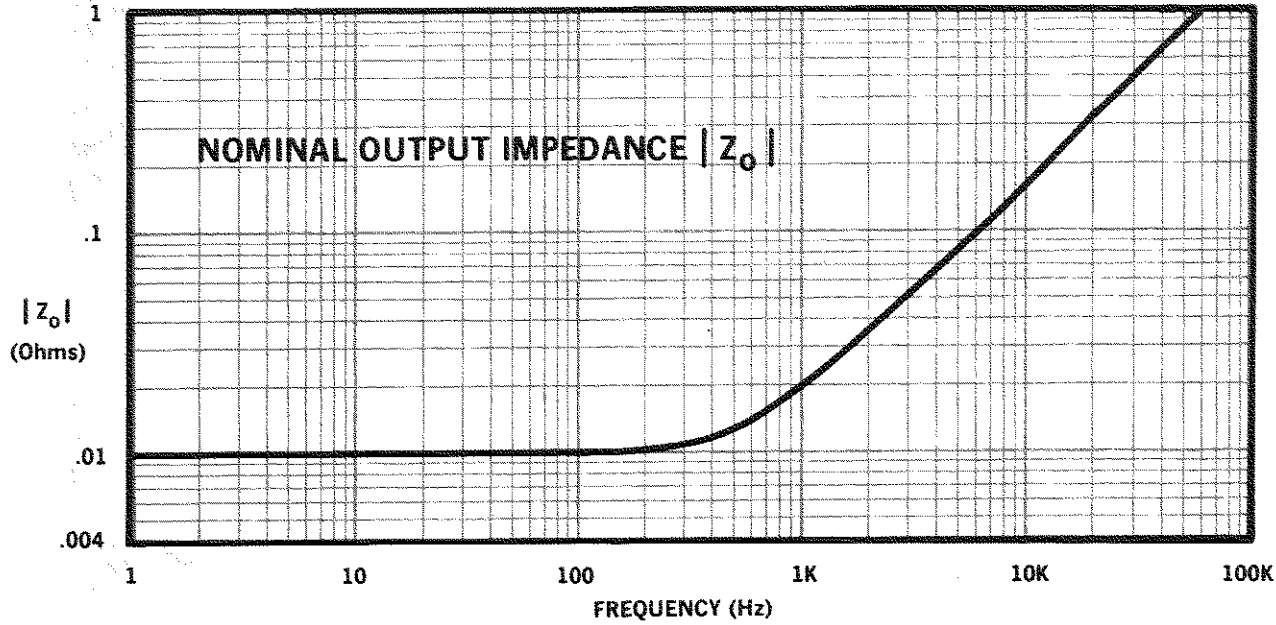

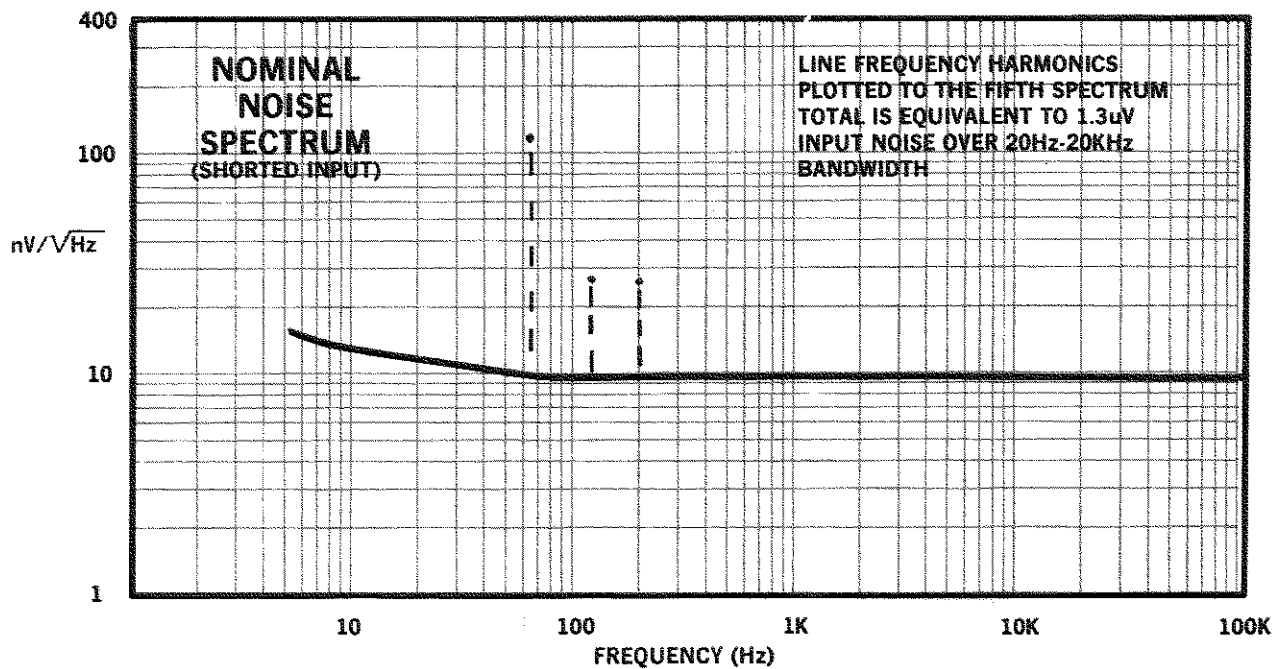
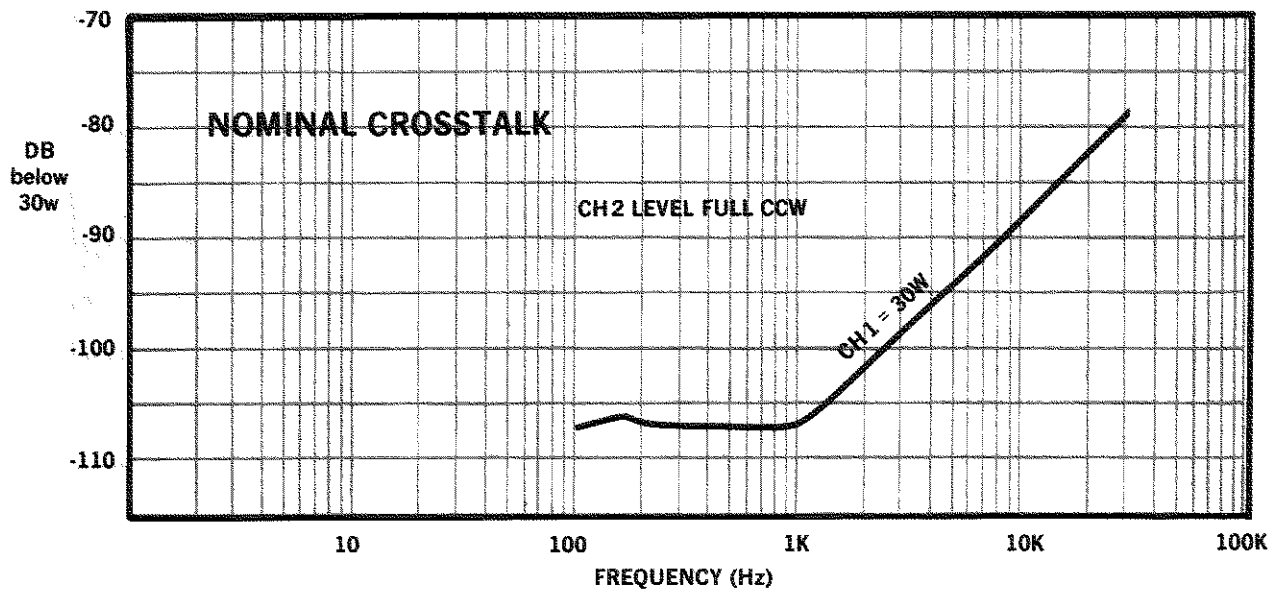
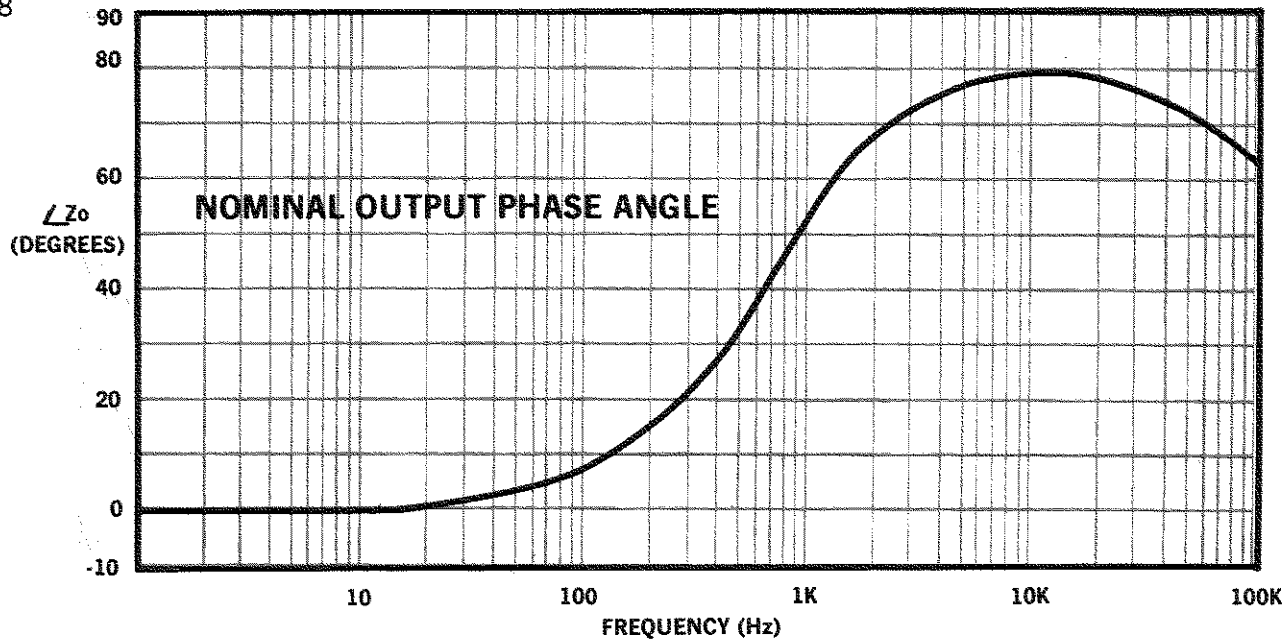

PARTS LIST, D-60 Page 1

(Starts SN 17526)

Schematic Designation	Description	Crown Part #	Other Information
	MAIN MODULE	41119	
	PC Board	7925	
	Capacitors		
C101, C201	25 MF 15V NP Vertical	3186	
C102, C202 C107, C207 C115, C215	200 PF Mica	3411	
C103, C203	100 MF 16V Vertical	3729	
C106, C206	.0015 MF 200V Filmatic	3089	
C108, C208	27 PF Mica	2342	
C109, C209	100 PF Mica	3410	
C110, C210 C111, C211	120 PF Mica	3290	
C112, C212	47 PF Mica	3409	
C113, C213 C119, C219 C4, C7	.01 MF Ceramic Disc	1751	
C116, C216	10 MF 50V Vertical	3728	
C5	4.7 MF 63V Vertical	4253	
	Resistors		
R102, R202 R108, R208	1K ohm ¼ watt 5% CF	2627	
R103, R203	510 ohm ½ watt 1% Film	3304	
R104, R204	10K ohm ¼ watt 5% CF	2631	
R106, R206	22K ohm ¼ watt 5% CF	3302	
R107, R207	3.9K ohm ¼ watt 5% CF	2630	
R109, R209	56K ohm ¼ watt 5% CF	2882	
R110, R210 R118, R218 R124, R224	10K ohm ½ watt 1% Film	2343	
R111, R211	Selected		
R112, R212	820 ohm ¼ watt 5% CF	3301	
R114, R214	56 ohm ¼ watt 5% CF	3511	

PARTS LIST, D-60 Page 2

Schematic Designation	Description	Crown Part #	Other Information
R115, R215 R116, R216	4.7K ohm ½ watt 5% CF	1640	
R117, R217	18K ohm ¼ watt 5% CF	2633	
R119, R219 R125, R225	180 ohm ¼ watt 5% CF	2873	
R120, R220 R127, R227	5.6 ohm ½ watt 5%	3299	
R121, R221 R122, R222	120 ohm ½ watt 5% Film	3837	
R123, R223	100 ohms ½ watt 5% CF	1007	
R126, R226	2.2K ohm ½ watt 5% Film	3145	
R132, R232	750 ohm ¼ watt 5%	3803	
*R135, R235	3.3K ohm ¼ watt 10%	2629	When IC u749 is used, must be connected from pins 1 to 7 and 7 to 13 on IC
*R135, R235	10K ohm ¼ watt 10%	2631	When IC u739 is used and instability occurs, resistor must be connected from pins 1 to 7 and 7 to 13 on IC
R5 R13	1.5K ohm 1 watt 10%	3497	
Transistors			
Q102, Q202	PN4250A	3786	
Q104, Q204 Q105, Q205 Q106, Q206 Q114, Q214	2N3859A selected	2961	
Q107, Q207, Q115, Q215	2N4125 selected	3625	Q115, Q215 started SN 17526
Q108, Q208	MPSA06	3528	
Q109, Q209	MPSA56	3954	
Q110, Q210 Q112, Q212	2N6175	3501	
Diodes			
D101, D201 D102, D202 D106, D206	1N4148	3181	
D103, D203	1N270	3447	
D104, D204 D105, D205	1N4003	2851	
D7, D8	1N961B, 10V zener	3549	

PARTS LIST, D-60 Page 3

Schematic Designation	Description	Crown Part #	Other Information
Integrated Circuits			
IC-1A, B	uA739 or uA749	3231 3643	May be substituted for uA739 with proper load resistor
Coil			
L101, L201	.5MHY axial lead	3510	
Miscellaneous			
	14 pin DIL IC socket	3450	
	Dual TO-92 cooler	3493	Used on Q108, Q208; Q114, Q214
	Transistor lead PC receptacle	3519	Used to mount R111, R211
	4-40 x 3/8 RHS screw	1844	Used to mount Q110, Q210, Q112, Q212
	#4 internal star washer	1824	Used to mount Q110, Q210, Q112, Q212
	TO-5 mica washer	3530	Used to mount Q110, Q210, Q112, Q212
	4-40 hex nut	1938	Used to mount Q110, Q210, Q112, Q212
BACK CHASSIS ASSY.			
	D-60 rear panel	9599-S	
OUTPUT	Dual binding post	2823	
	Heyco strain relief	2803	Fastens power cord
	3 #18 male power cord	3474	
	HTA fuseholder	3256	
F2	2A 3AG fuse	2163	External fuse for operation below 200V
	1A 3AG fuse	3065	External fuse for operation 200V and above
INPUT	112A, 2-cond. Hi-D jack	3423	
	Fiber washer	1646	Mounts jack
	Fiber shoulder washer	1306	Mounts jack
R36	10K 1/2 watt 1% Film	2343	
C122, C222	.1 MF 200V Filmatic	2938	Mounted on output terminals
R129, R229	2.7 ohm 1 watt 10%	1001	Mounted on terminal strip
SW2	DPDT slide switch	4110	Mono-Stereo switch. Earlier units used CPN 2668.
	Brass eyelets	3529	Fastens SW2

PARTS LIST, D-60 Page 4

Schematic Designation	Description	Crown Part #	Other Information
	CAPACITOR BRACKET ASSY.		
C23, C24	10,000 MF 40V	4250	
	Solder lug	2934	Terminals for C23, C24
	10-32 x 1/2 THP screw	2049	
	#6 flat washer	2101	
	#10 internal star washer	2279	
	3/4" fiber shoulder washer	1648	
DM1	VH148, 6A bridge	3062	
	#6 solder lug	3163	
	6-32 hex nut	1889	
	6-32 x 3/8 BHP screw	2134	
R34	1 ohm 1/2 watt 5% CF	3612	Mounted on common terminal for C23, C24 to lug at DM1.
	D-60 bracket	9591-S	Fastens both sides of main PC board
	4-40 x 1/4" SSET screw	4163	
	#4 internal star washer	1824	
	4-40 hex nut	1938	
	8-32 x 1/4 THP screw	2271	
	#8 internal star washer	1951	
	8-32 captive nut	2018	
	FRONT PANEL ASSEMBLY		
	D-60 front panel	4083	
	D-60 front panel overlay	4084	
	N112B 3-cond. Hi-D jax	3507	
	3/8" internal star washer	2188	One on jack, one on SW1
	3/8" black washer	3628	Mounts jack
	3/8" black knurled nut	3495	Mounts jack
	1/4" internal star washer	2365	Mounts R101, R201
	Solder lug	3515	Mounts over R101
	Terminal strip	3503	
	6-32 x 3/8 BHP screw	2134	Mounts terminal strip
	6-32 hex nut	1889	Mounts terminal strip
	1/2" rubber transformer mount	3556	Mounts on back of T1
	Nylon transformer pin	3557	Mounts T1 to front panel
	Speed nut	3558	Mounts T1 to front panel

PARTS LIST, D-60 Page 5

Schematic Designation	Description	Crown Part #	Other Information
	3" foam tape	1152	Mounts T1 to front panel
	6-32 captive nut	2019	Mount on bottom back edge of FP channel
	Anodized TO-3 insulator	4039	Mounts outputs
	TO-3 insulator	4071	Mounts outputs
	6-32 x 1/2 BHP screw	2176	Mounts outputs
	#6 internal star washer	1823	Mounts outputs
	#6 solder lug	3163	Mounts outputs
	6-32 hex nut	1889	Mounts outputs
	Feed-through terminals	3502	
C6	.01 MF ceramic disc	1751	
C21	5MF 70V	1678	
I1	Neon lamp, NE2H	2500	Mounts on terminal strip
SW1	D-60 power rotary switch	3492	
R31	27K ohm 1/2 watt 5% CF	1056	Mounts on terminal strip
R33	2.7 ohm 1/2 watt 5% CF	2857	Mounts from gnd lug at input pot to main board
R101, R201	25K ohm audio taper pot	3494	Input level control with nut
R128, R228 R130, R230	.1 ohm 5 watt 10% Wire	3291	Mount on solder lugs attached to outputs
Q111, Q211 Q113, Q213	2N3055 selected, Motorola <i>C4751-1</i>	4152	Output transistors on bottom of FP channel
T1	D-60 transformer, 10403-P2	4246	Starts SN 14484
	Nylon shoulder washer	4251	Mounts transformer
	8-32 x 7/8 RHP screw	4252	Mounts transformer
	Fuseblock	3776	
	Double-sided foam tape	1152	Used to mount fuseblock
F1	2.5A AGC fuse	3775	Internal fuse
	Fuse Caution label	4402	
	Control knob, A-1	4076	For input pots R101, R201
	Control knob, A	4075	For power switch SW 1
	D-60 serial number label	4193	
	2A 120 VAC label	3891	
	1 1/4" end bars	4085	
	6-32 x 3/8 SCP screw	1858	Mounts end bars
	D-60 bottom cover	41166	With 2, 8-32 captive nuts
	D-60 bottom cover	9590-S	Without the captive nuts
	8-32 captive nuts	2018	Install on bottom cover
C123, C223 C125	.01 MF Ceramic disc	1751	

PARTS LIST, D-60 Page 6

Schematic Designation	Description	Crown Part #	Other Information
	8-32 x ¼ FHP screw	2136	Mounts bottom cover
	8-32 x ⅜ FHP screw	2274	Mounts bottom cover
	6-32 x ¼ FHP screw	2436	Mounts bottom cover
	Self-stick rubber feet	3342	Installed on bottom cover
	D-60 top cover	9614	
	6-32 x ⅜ BHP screw	2134	Holds front of top cover
	#8-18 x ⅜ #6 SMT screw	3958	Holds back of top cover
L102, L202	OUTPUT INDUCTOR ASSY.	41145	
	Output torroid core	2850	
	15¾" #18 brown wire	3585	
	8-32 x 1½ THP screw	2277	
	Nylon spacer	2762	Insulates coil from screw
	Nylon washer	3609	One each side of coil
	#8 internal star washer	1951	Mounts coil
	8-32 hex nut	1986	One each side of coil
	#10 solder lug	3312	Mounted under coil
	2ALUE #10 terminal strip	3504	Mounted on top of coil
	ACCESSORIES		
	RMB-2 Kit	41626	
	4 x 4 polybag	3046	
	7/64 Allen wrench	3454	
	1¾" rack mount	4086	
	10-32 panel thumbscrew washer assy.	20032	
	Hi Fi Adapter Kit	40377	
	Pin-phone cables	3339	
	Dual banana plugs	2981	
	Model 74B wire nuts	3069	
	Polybag	3073	
	3 AG Fuseholder with 1.5A fuse	4245	

**NOMINAL LIMITS
OF
V-I OUTPUT**

**DISCLOSURE
PROHIBITED
effective Nov. 4, 1974**

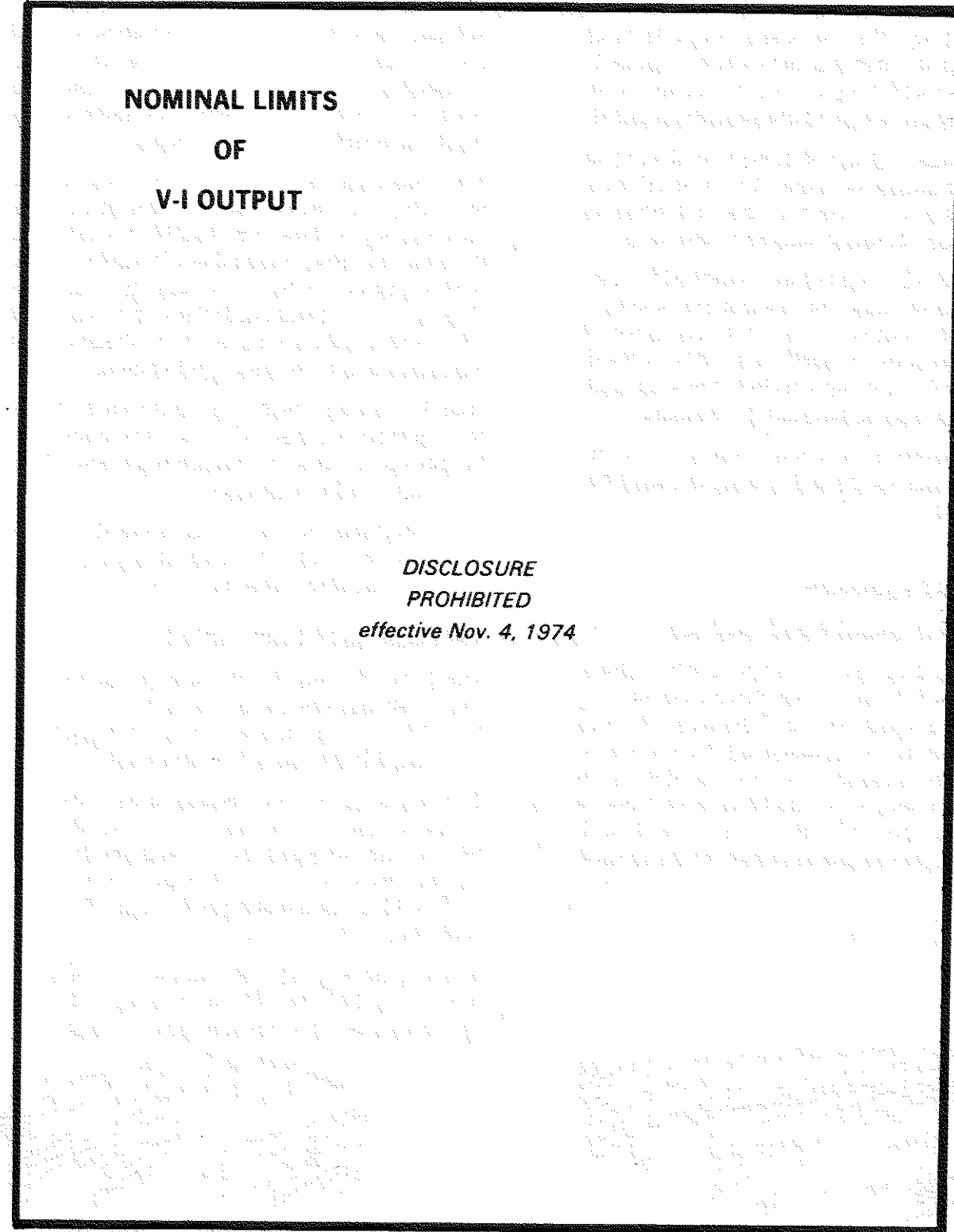

16
14
12
10
8
6
4
2
0 **I_{OUT}**
-2
-4
-6
-8
-10
-12
-14
-16

-60 -50 -40 -30 -20 -10 0 10 20 30 40 50 60

V_{OUT}

1.3 WARRANTY

CROWN guarantees this equipment to perform as specified. CROWN also warrants the components and workmanship of this equipment to be free from defects for a period of 3 years from date of purchase.

This warranty does not extend to fuses, and/or component or equipment damage due to negligence, misuse, shipping damage or accident; or if the serial number has been defaced, altered or removed.

A copy of the FULL THREE-YEAR WARRANTY is included with this manual. The WARRANTY is subject to the conditions contained therein. Upon receipt of the registration form, CROWN will issue a WARRANTY TITLE. This title applies to the original end-purchaser as well as subsequent purchasers.

You, the purchaser(s), are responsible for accurate, complete records (sales slips, invoices, etc.) for FULL coverage!

1.4 ACCESSORY EQUIPMENT

1.4.1 "R" SERIES WALNUT ENCLOSURES

Rich oiled-walnut veneers, highlighted with flatback trim, accent the D-60 when installed on a shelf or table in an "R" series enclosure. The design of these enclosures permits vertical stacking of several components. Several cabinet sizes are available which accommodate multiple components in one enclosure. Available sizes are 5-R, 7-R, 10-R, and 14-R. Custom sizes are available through our factory Parts Department.



FIG. 1-2
D-60 and VFX-2A IN OPTIONAL 5-R
ENCLOSURE

1.4.2 VFX-2A

The CROWN VFX-2A is a dual-channel variable electronic filter-crossover. When used with a power amplifier it can greatly add to the total system capability. In combination with the D-60, the VFX-2A adds several convenient useful functions.

The connections are made with the VFX-2A quickly and easily. If a balanced line is to be used with the unbalanced input of the D-60 the VFX-2A can serve as the interface. While maintaining these functions the output can be shaped by selecting variable high-pass, lo-pass, or band-pass filters. As a filter, the VFX-2A can be used as a crossover or ahead of several amplifiers in a bi- or tri-amped system.

Overall noise and distortion are extremely low, with IM distortion less than .01% at rated output (2.5V into 600 ohms), and noise more than 100 dB below rated output with 0 dB gain.

For further information please request the VFX-2A specification sheet or for a nominal fee, purchase a VFX-2A instruction manual.

1.4.3 UMX-300 TRANSFORMER

The CROWN UMX-300 transformer offers a maximum 300 watts of power with IM distortion of less than .015%. Frequency response for the unit is rated +0, -1dB, 20Hz to 20KHz at 300 watts.

Connections are made through a five-screw input-output terminal strip mounted on the front. Three holes in the flanges on each side of the casing allow convenient mounting of the unit. The UMX-300 weighs 23 lbs. and measures 6" high x 4.75" wide x 5.25" deep.

The auto-transformer configuration can convert any input of 25, 35, 50 or 70 volts to an output of 25, 35, 50, or 70 volts at any power level up to 300 watts.

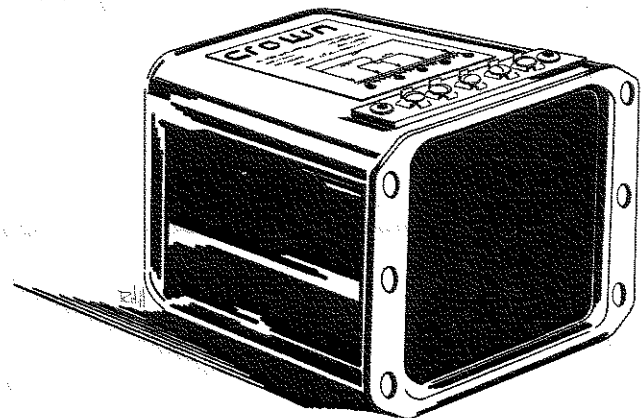

FIG. 1-3
UMX-300 TRANSFORMER

INSTALLATION

2.1 UNPACKING

As soon as the amplifier shipment is received, please inspect for any damage incurred in transit. Since the unit was carefully inspected and tested at the factory, it left the factory unmarred. If damage is found, notify the transportation company immediately. Only the consignee may institute a claim with the carrier for damage during shipment. However, CROWN will cooperate fully in such an event. Be sure to save the carton as evidence of damage for the shipper's inspection.

Even if the unit arrived in perfect condition — as most do — it is advantageous to save the packing materials. They will prove valuable in preventing damage should there ever be occasion to transport or ship the unit. Note the carton and internal pack — each is designed for protection during transit. Do not ship the unit without this factory pack!

2.2 MOUNTING

The D-60 is shipped with end-caps installed. These end-caps are used for custom panel mounting.

In such a "custom installation," install a solid shelf, to support the amp. It should be flush with the bottom edge of the required 17" wide x 1 3/4" high panel-cut-out. The shelf should have a hole cut in it to allow air to circulate freely to the louvers in the bottom cover.

Angle brackets supplied with the D-60 are used for rack mounting and for installation into the 5-R or other larger CROWN "rack" cabinets. Align these angle brackets on the unit to match the holes which held the end bars. Use 6/32 x 1/2" socket cap screws (Note: Socket screws may look as though they are crossthreading but will straighten approximately halfway through). See figure 2-1.

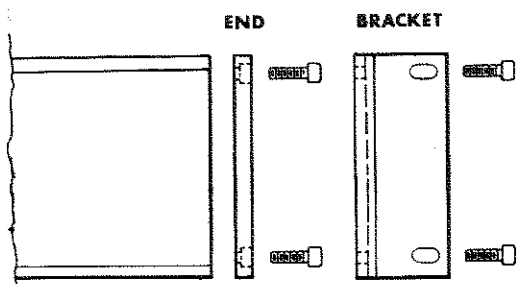

FIG. 2-1
END-CAP/BRACKET MOUNTING

Sufficient ventilation must be provided for the unit. This means that air must be allowed to circulate over the chassis to prevent overheating. Applications — other than "Hi-Fi" — requiring long, sustained signals at high power-levels may require the use of a cooling fan. When rack mounting, it is a good practice to allow a 1 3/4" space above and below the unit. (See figure 2-2 for mounting dimensions.)

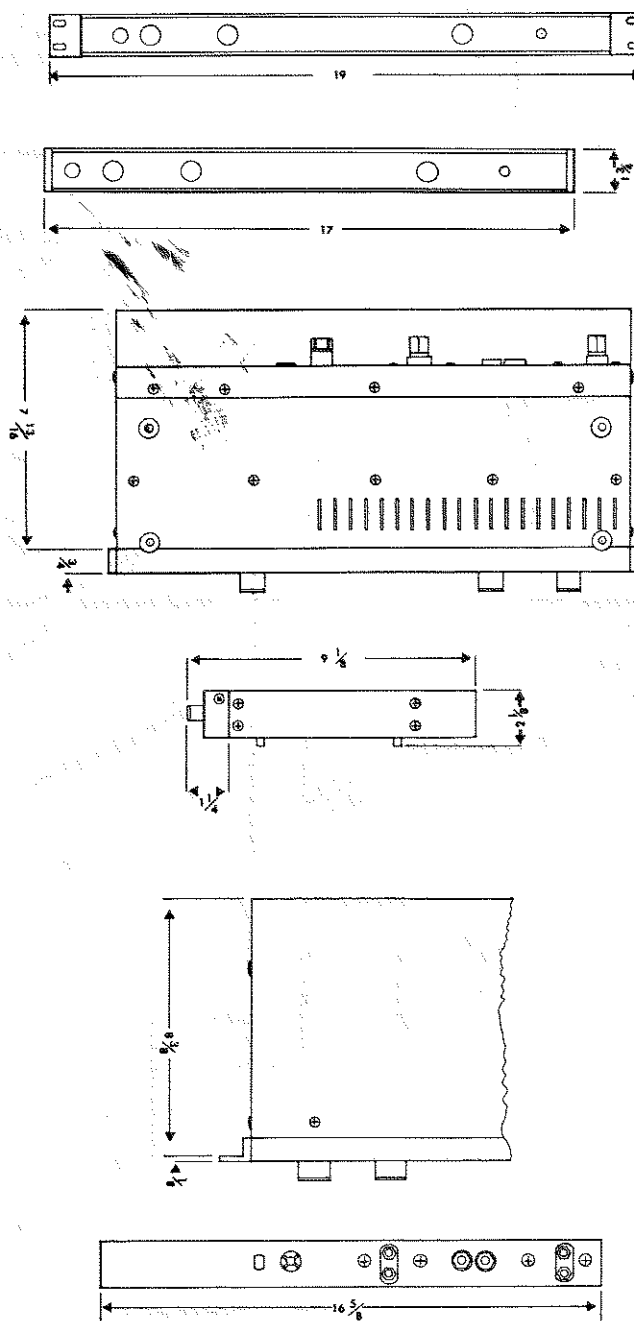

FIG. 2-2
D-60 MOUNTING DIMENSIONS

POWER AMPLIFIER PROTECTION SYSTEMS PROTECT AMPLIFIERS, BUT NOT SPEAKERS!

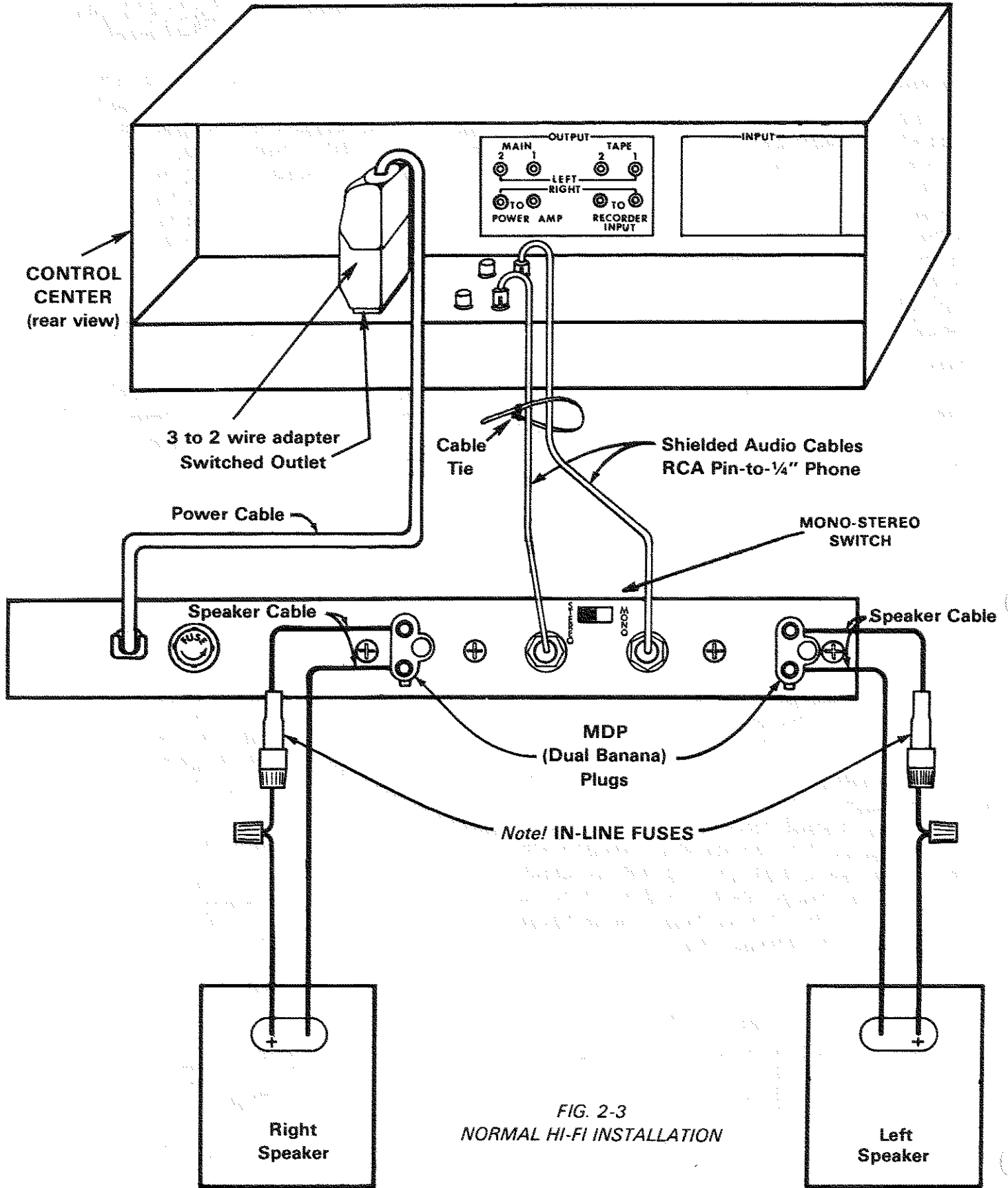

FIG. 2-3
NORMAL HI-FI INSTALLATION

YOU, AND/OR YOUR SPEAKER MANUFACTURER ARE RESPONSIBLE FOR SPEAKER PROTECTION

2.3 NORMAL HI-FI INSTALLATION

1. Two-conductor speaker cables must connect to the OUTPUT dual binding posts using terminal lugs, tinned ends, or "banana" plugs.

2. Since the D-60 is a "basic amplifier," the main outputs of the control-center or "preamplifier" must be connected via shielded audio-cables to the two jacks marked INPUT. Use RCA-pin at preamp and standard ¼ in. phone-plug at the D-60.

The two cables should be tied parallel along their entire length using the accessory cable ties.

3. U/L requirements prefer a 3-wire AC power connector; however, proper connections to a switched outlet on the control center requires the use of a 3-to-2 wire adapter. NOW, plug the AC into a **switched** outlet on the control center.

4. Your Control Center may now be turned on. Then advance the D-60 Input-Gain Controls about ½-open (150° clockwise).

When using the CROWN IC-150A Control-Center, the VOLUME should attain almost full rotation (2 to 4 o'clock) for loudest "concert-hall" volume. If at 3 o'clock the volume is low, increase the D-60 input gain controls; if too high, decrease the D-60 gains.

To assure maximum enjoyment and full speaker protection, read the following detailed sections on OUTPUTS, INPUTS and Chapter 3 - OPERATION.

2.4 CONNECTING OUTPUT LINES

Input and output connectors are located on the chassis as shown in Fig. 2-4.



FIG. 2-4
REAR VIEW OF CHASSIS

It is always wise to remove power from the unit and turn the input level controls off while making connections, especially if the load is a loudspeaker system. This will eliminate any chance of loud blasts. CROWN is not liable for damage incurred at any transducer to its being overpowered! The use of speaker fuses is recommended.

Before making connections, it is recommended that the operator familiarize himself with the amplifiers protective system. See Section 3.2. Section 3.3 entitled "Operating Precautions" should also be read.

Because the output wire gauge and length raises the resultant source impedance or lowers the Damping Factor by adding series resistance, the nomograph (Fig. 2-6) is provided for wire selection. For dynamic moving-coil loudspeakers the value R_L should preferably be that measured by an ohmmeter across the voice coil, rather than the manufacturer's rating. For electrostatic speakers and such, the manufacturer's rated impedance should be used for R_L .

If the load (matching transformer, inductance, or full-range electrostatic speaker system) appears as a short-circuit at low frequencies, a large non-polarized capacitor (paralleled with a resistor) should be placed in series with the load.

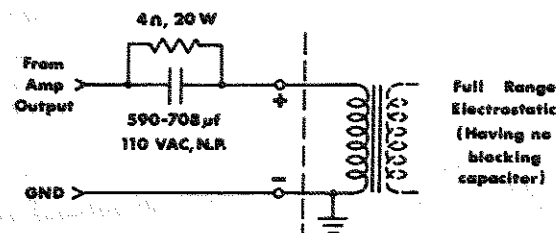

FIG. 2-5
SCHEMATIC FOR FULL RANGE
ELECTROSTATIC SPEAKER CONNECTION

For electrostatic speakers (if the manufacturer has not provided a capacitor) an external non-polar capacitor of 590-708 mfd and 4 ohm power resistor should be placed in series with the plus (+) speaker lead. This will prevent large low-frequency currents from damaging the electrostatic transformer or from unnecessarily activating the D-60's protective system. An effective

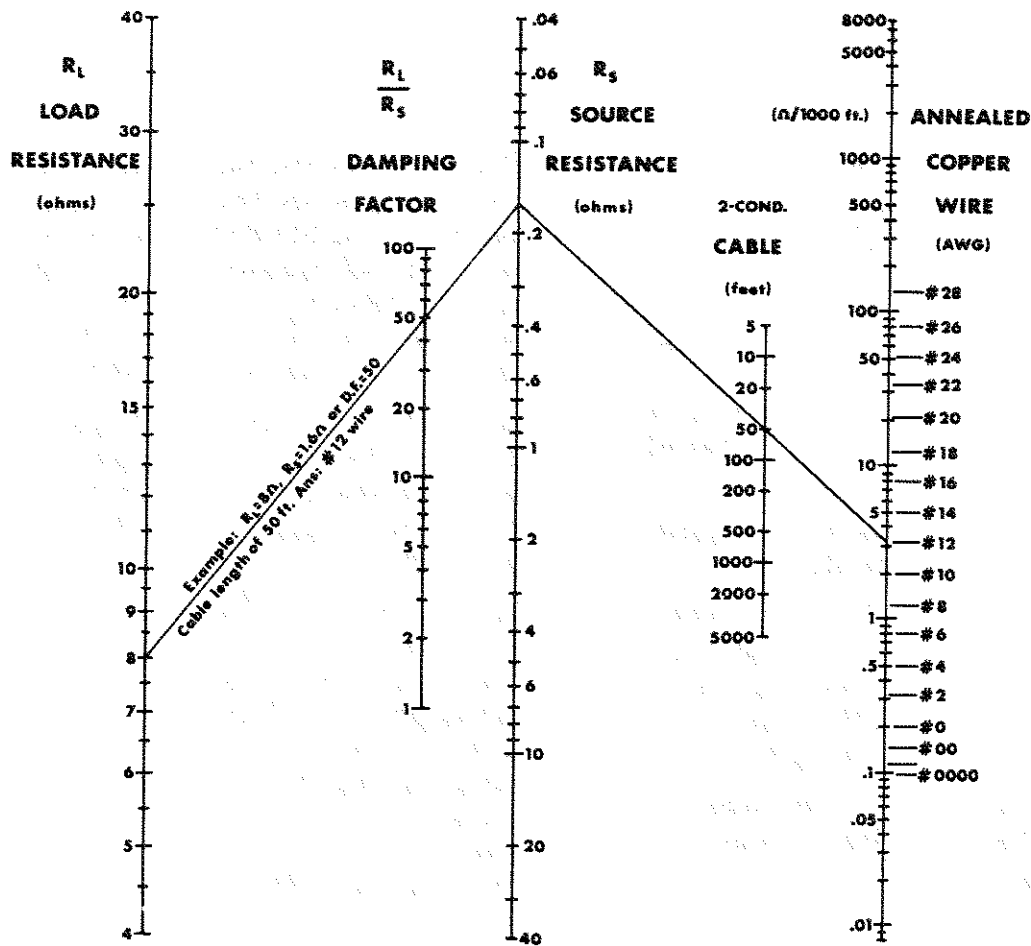

FIG. 2-6

SOURCE RESISTANCE and DAMPING FACTOR VS. LENGTH and SIZE of OUTPUT LEADS

test to determine if such parts are needed is to measure the DC resistance between the output terminals with an ohmmeter. If the resistance is less than 3 ohms, the parts should be added as shown schematically in Fig. 2-5.

When selecting connectors for the load (speaker) end of the output lines, the following general precautions apply (with all power connectors):

1. A male plug, carrying signal, must not be on the far end of the line where it can be exposed, giving rise to both shock and short-circuit hazards.
2. Connectors which might accidentally cause the two channels to be tied together during making and breaking of connection should not be used.
3. Connectors which can be plugged into AC power receptacles should **never** be used.
4. Connectors having low-current carrying capacity are "verboten."
5. Connectors having any tendency to short, or having shorted leads, are inadvisable.

2.4.1 MONO OPERATION

A mono-stereo switch on the rear panel adjacent to the input jacks, allows the D-60 to be operated normally (stereo) or in mono, with no internal modification. (See figure 2-7.) When in the mono position, the input circuitry of the D-60 is changed so that the two amplifiers are "added" for mono output. (See mono specifications, page 3).

Care must be taken in the external hook-up to assure proper operation. Proceed as follows:

1. The input line should be plugged into the channel 1 input jack. The level is adjusted with the Channel 1 input level control.

NOTE: The Channel 2 input jack and level control are not defeated in the Mono mode. However, the Channel 2 input should not be used in this mode. If a Channel 2 input is added to the Channel 1 input, distortion may result. If Channel 2 input is used alone, very low power output will result. For best results unplug the input to Channel 2 when operating Mono.

2. Connect output lines as per the following drawing, Figure 2-7. The output from the D-60 in Mono is **BALANCED** and is isolated from the chassis, and from the input grounds to the D-60.

CAUTION: Be certain that all equipment (meters, switches, etc.) connected to the Mono output lines is balanced. Both sides of the line must be totally isolated from the input grounds, to the D-60. If this is not observed, severe oscillation may result.

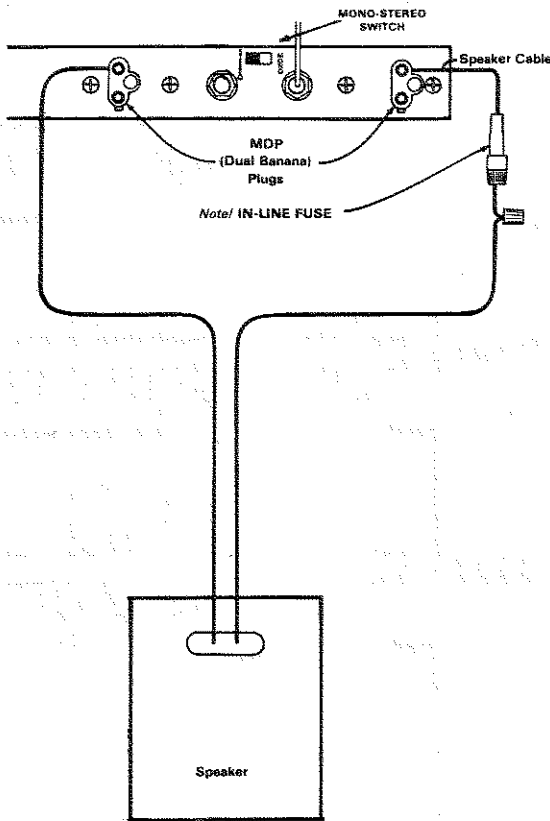

FIG. 2-7
D-60 MONO HOOK-UP

2.5 CONNECTING INPUT LINES

Connecting the inputs will require observance of three basic precautions: Undesirable signals to the inputs, "ground loops," and feed back from output(s) to input(s).

In high-fidelity audio applications any good vacuum-tube or solid-state control center will operate successfully into the 25K ohm inputs of the D-60. Occasionally a high-impedance output of poorly-designed preamps will be encountered, and/or a larger output coupling capacitor may be required (to prevent excessive low-frequency rolloff).

For loudspeaker-driving applications, the input should be free of large sub-audio or undesired low frequencies, as they cause overheating and overloading of the loudspeaker. To remove such low frequencies, a series capacitor may be placed in the input signal line. (The graph of figure 2-8 indicates the effect of the size of the capacitor on the frequency response.) Only a low-leakage paper, mylar, or tantalum capacitor should be used for this purpose.

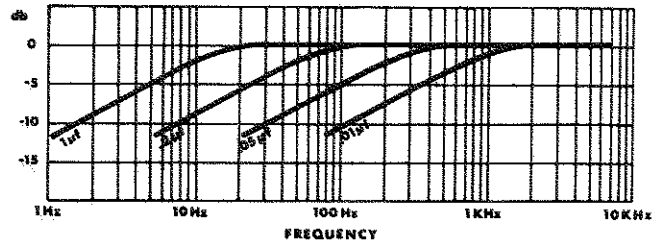
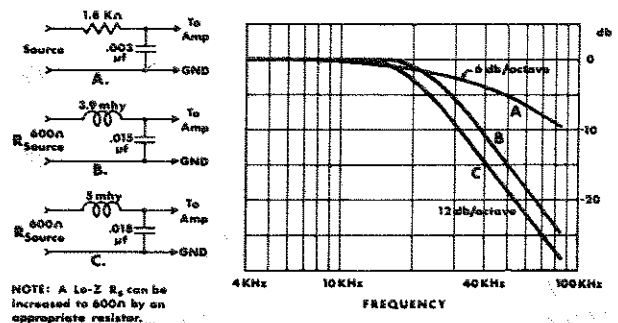

FIG. 2-8
GRAPH for SELECTION of INPUT CAPACITOR

If large amounts of ultrasonic or RF frequencies are found on the input, such as bias from tape recorders, etc., a low-pass filter should be placed on the input. While practically-obtainable RF input levels will not damage the amplifier, they may cause burn-out of tweeters or other sensitive loads, activate the amplifier's protective systems, or cause general overload in the controlled-slew-ing-rate stage of the amp (which is employed to provide RF overload protection). The following filters are recommended for such applications.



NOTE: A Le-Z R₂ can be increased to 600Ω by an appropriate resistor.

FIG. 2-9
LOW-PASS FILTERS
FOR SEVERE RF AT INPUTS

A second precaution is "ground loops" — electronic jargon for undesirable circulating currents flowing in a grounding system. A common form of loop (possibly resulting in hum in the output) is a

pair of input cables whose area is subjected to a magnetic hum field. In practice, both cables should lie together along their length, and away from the power transformer. Tying the input and output grounds together may also form a ground loop.

A third precaution (with input and output grounds together, as in testing or metering) is feedback oscillation, from load current flowing in the loop. In industrial use, even the AC power line may provide this feedback path. Proper grounding, and isolation of inputs, of common-AC-line devices is good practice. Refer to Section 4.2, par. 5 for testing precautions.

2.6 CONNECTING POWER

The amplifier is furnished with a three-wire AC plug as standard equipment. Adapters are readily available commercially for adapting this to a two-wire system if necessary.

The D-60 power supply may be connected for any of five voltages. Converting from one to another can be simply accomplished with a soldering iron and a pair of wire cutters. Follow the table shown with the schematic, and the drawing below.

- 1) Remove the top cover of the D-60 (held on by 8 screws).
- 2) With the unit right side up, and the front panel toward you, locate the terminal strip on the front in the near right-hand corner.
- 3) Make the appropriate change in jumpers for the desired operating voltage.
- 4) Replace the 2 amp line fuse with a 1 amp type 3AG fuse, for all connections 200V and above.
- 5) Change the line cord tag to read the correct voltage.

When testing the amplifier, the line voltage must be the peak equivalent to a sinusoid of the indicated line voltage when at full load. Line regulation problems can introduce serious errors in the measurements on an amplifier.

Only a competent technician should attempt alteration of the line voltage connections.

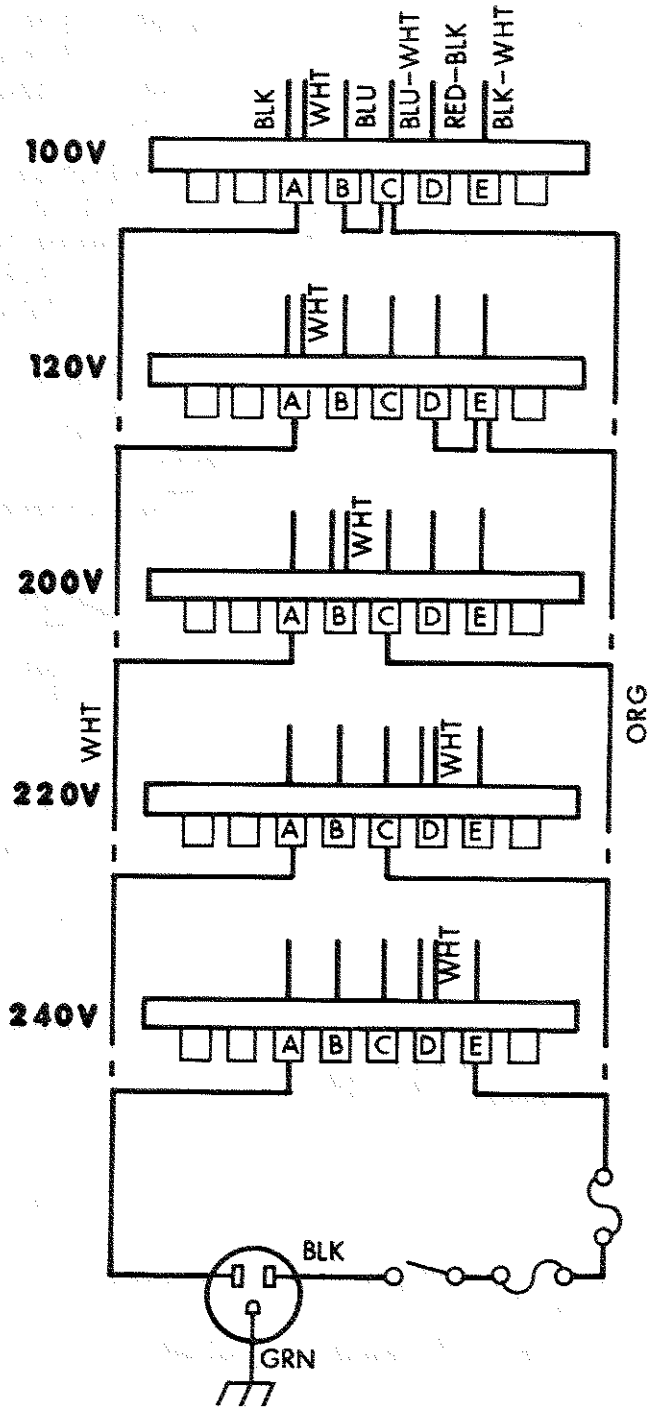

FIG. 2-10
LINE VOLTAGE CONNECTIONS

OPERATING INSTRUCTIONS

3.1 CONTROLS AND ADJUSTMENTS



FIG. 3 - 1
OPERATING CONTROLS

The D-60 contains all the facilities essential for a high performance amplifier.

The input level controls are mounted on the front panel. Each control should be adjusted for the desired amplifier gain or output level. When the control is fully CW, the gain is 26db as determined by precision 1% resistors in the D-60's feedback loop.

3.2 THE PROTECTION MECHANISMS

The D-60 is protected against the common hazards which plague power amplifiers, including shorted, open, and mismatched loads; overloaded power supplies; chain destruction phenomena; input overload damage; and high frequency overload blowups.

Protection against shorted and mismatched loads is provided by an instant-acting limiter which instantaneously limits at the volt-ampere product to the maximum safe-stress value for the output transistors.

The area in which the amp will drive the load without being V-I limited is depicted by the cross-hatched areas of Fig. 3-2.

If a load initiates protection in the amplifier, it can be detected generally by watching the transfer characteristics of the amplifier on an oscilloscope or by plotting the load's V-I behavior, if known, on to Fig. 3-2. In applications where the

load is a loudspeaker, amplifier protection will be evidenced by distortion in the speaker. The audible effect ranges from something resembling cross-over notch distortion to a snapping sound, depending on the over-all load characteristics. Speaker systems which are truly 4 ohms or greater will not initiate the protection system.

The AC line for below 200V is fused with a 2A, 250V type AG fuse (above 200V; 1A type AG). The use of any other type of fuse will invalidate the warranty.

All the amplifier's voltage-amplifiers circuitry is designed to be inherently current-limited. Thereby, if any of the devices should fail, (which is extremely unlikely) no damage will occur to the rest of the stages.

The input stage is protected against overdrive damage by a series limiting resistor should the input signal level ever become very excessive.

The amplifier features a controlled slewing-rate which, coupled with the V-I limiter, protects the amplifier from blowups when fed large RF input signals.

**NOMINAL LIMITS
OF
V-I OUTPUT**

**DISCLOSURE
PROHIBITED
effective Nov. 4, 1974**

-60 -50 -40 -30 -20 -10 0 10 20 30 40 50 60

16
14
12
10
8
6
4
2
0
-2
-4
-6
-8
-10
-12
-14
-16

V_{OUT}

I_{OUT}

3.3 OPERATING PRECAUTIONS

The following are a number of operating precautions given as an aid to understanding proper and improper amplifier usage:

1. Use care in making connections, selecting signal sources, and controlling the output level. The loudspeaker you save may be your own. CROWN is not liable for any damage done to loads due to careless amplifier usage or deliberate overpowering. For pointers on load protection see Section 3.4.
2. Never parallel the two outputs by directly tying them together or parallel them with any other amp's output. Such connection does not result in increased power output. Damage incurred by such operation is not covered by the warranty.
3. Never drive a transformer-coupled device or any other device which appears as a low frequency short (less than 3 ohm) without a series isolating capacitor. Such operations may damage the device and/or needlessly activate the V-1 limiting (see Fig. 2-5).
4. Do not short the ground lead of an output cable to the input signal ground as oscillations may result from forming such a ground loop.
5. Operate and fuse the amplifier only as set forth in section 3.2.
6. Operate the amplifier from AC mains of not more than 10% above the selected line voltage and only on 50, 60 or 400Hz AC. Failing to comply with these limits will also invalidate the warranty.
7. Never connect the output to a power supply output, battery, or power main. Damage incurred by such a hookup is not covered by the warranty.
8. Do not expose the amplifier to corrosive chemicals such as soft drinks, lye, salt water, etc.
9. The amplifier is not recommended for high power industrial usage at frequencies above 30KHz.

10. Tampering in the circuit by unqualified personnel or the making of unauthorized circuit modifications invalidates the warranty.
11. Do not expose the output leads to areas likely to be struck by lightning. Such an installation could invalidate the amplifier.

3.4 LOAD PROTECTION METHODS

The most common of all protection schemes is a fuse in series with the load. The fuse may be single, fusing the overall system. Or, in the case of a multi-way speaker system, it may be multiple with one fuse on each speaker.

Fuses help to prevent damage due to prolonged overload, but provide essentially no protection against damage that may be done by large transients and such. To minimize this problem, high-speed instrument fuses such as Littlefuse 361000 series are most appropriate for such applications. For a nomograph showing fuse size vs. loudspeaker ratings refer to Fig. 3-3.

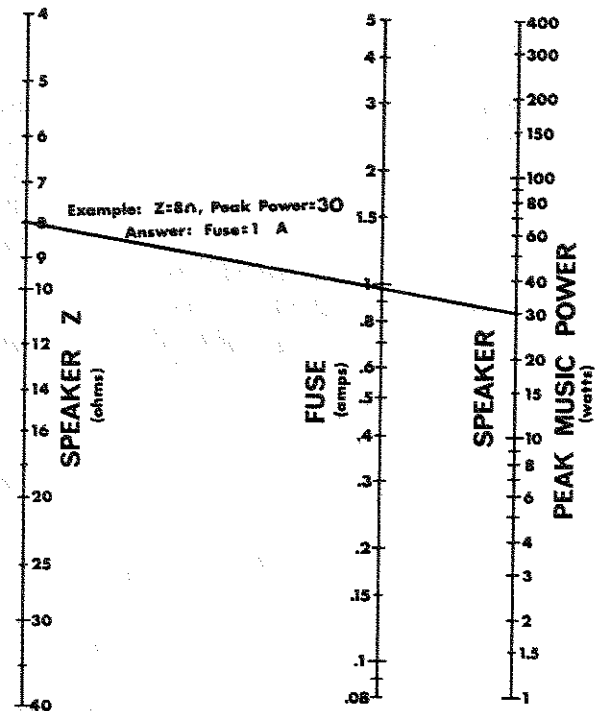

FIG. 3 - 3
FUSE SELECTOR NOMOGRAPH FOR
LOUDSPEAKER PROTECTION

Another form of load protector is shown schematically in Fig. 3-4. Whenever the load is overdriven, a relay switches a lamp in series with the load; smoothly relieving the overload. The lamp then doubles as an overdrive indicator as it glows. If overdrive is unreasonably severe, the lamp will serve as a fuse. By adjusting the relay tension adjustment and the protection level control, this system is useful from 25 to 200 watts for a typical 8 ohm load.

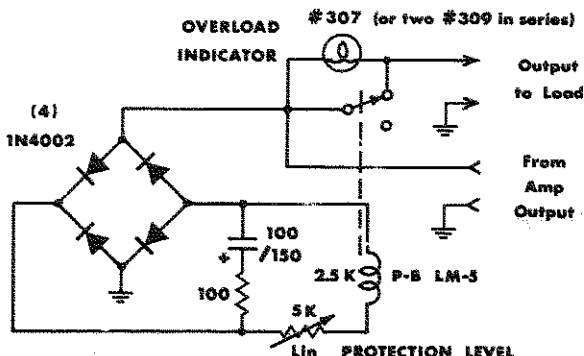

FIG. 3 - 4
RELAY-CONTROLLED PROTECTOR
WITH OVERLOAD INDICATOR

A common problem which causes damage and irritation is the turn-on thump problem typical to many signal sources. Fig. 3-5 shows the schematic of a muter which, when inserted in the input signal line, mutes for several seconds before connecting the source to the amplifier, thereby eliminating turn-on transients. It also removes turn-off transients occurring after the relay drops open (≈ 0.1 sec.).

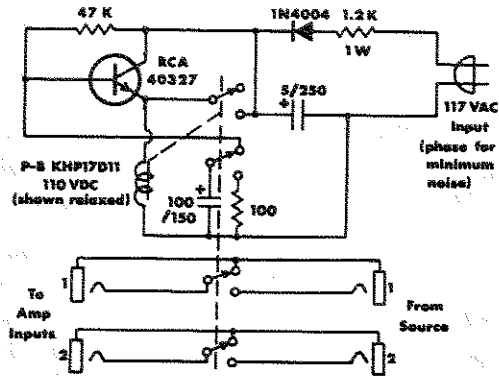

FIG. 3-5
TURN-ON-TRANSIENT MUTER
FOR LOAD PROTECTION

NOTE: When using the CROWN IC-150 this muter is not required. A built-in muter protects your speakers from any signal source whose AC power is switched by the IC-150.

3.5 CLEANING

The CROWN D-60 has a rugged anodized front panel for life-time service. The panel can be cleaned with a moist cloth and mild detergent. Never use steel wool, scouring powder, lye solution, or any strong abrasive cleaner as these will damage the panel's finish.

The chassis should require no more cleaning than periodic dusting with a clean dry cloth.

CIRCUITRY**4.1 PRINCIPLES OF OPERATION**

The D-60 has two direct-coupled amplifier circuits which employ a dual IC op amp and silicon transistors in all stages. The CROWN designed and developed circuit represents a level of quality and performance presently unequaled in the field of audio amplifier design.

The dual IC op amp is of a low noise type having a large gain bandwidth. The results of using it for the input voltage amplifier is that a maximum amount of feedback is applied reducing distortion to record low values. Multiple feedback loops are employed to allow a maximum of overall feedback.

The lack of noise is evidenced by a typical 20Hz - 20KHz effective input noise of 1.25 μ volts which produces an effective 8 ohm output of 80 micro-micro (pica) watts.

The output stage is a quasi-complimentary format employing the CROWN class AB+B technique which uses no bias current in the output transistors. The result is maximum efficiency with minimum crossover notch distortion and idling amplifier-heat. Thus there is no bias current adjustment, as the output circuit is not temperature-tolerance critical.

In the new output circuit, the driver transistors carry the bias current, while the output transistors serve only as boosters. The output transistors sense when the driver transistors are delivering significant current to the load and take over and deliver the large load currents.

The output circuit is protected by a V-I limiter which limits the drive to the output configuration whenever the output transistors are overloaded. V-I (volt-ampere) limiting is inherently superior to all other forms of protection as it directly senses the overload condition and acts instantly to relieve the overload, acting only so long as the overload exists. The result is complete freedom from program delays with reliability and maximum safe output power.

The power supply is a continuous-duty type. The main DC supplies are full-wave capacitor input type with a heavy duty bridge rectifier assembly and computer grade electrolytics.

The D-60 represents nothing short of the highest quality in both circuitry and components. It should provide a lifetime of trouble-free service for the most discriminating users.

4.2 TEST PROCEDURES

The sole function of this section is to list precautions essential to obtaining accurate measurements when dealing with high-purity amplifiers such as the D-60.

1. Use the proper line voltage, which is the one for which the amplifier is connected. The voltage should be measured throughout the testing with a peak reading meter, and adjusted to the RMS equivalent voltage (to compensate for line voltage regulation errors during the course of the measurements). All measurements should be taken at the power amplifier's plug. When testing for IHF music-power measurements, the line voltage is to be set at 120V when the amplifier is connected to 120V, (IHF standards). If the amp is connected for 240V equivalent test may be given by applying 240 volts.
2. The load should be resistive, having less than 10% reactive component at any frequency up to five times the highest test frequency. The resistor should be capable of continuously dissipating the full output of the amplifier while maintaining its resistance within 1% of its rated value. The load should employ only high-current connectors (if any), and be connected to the binding-post output terminals. All output measurements should be taken at the amplifier output terminals, and not anywhere along the output cable thru which the load current is flowing.
3. The input level controls should be set to maximum for all distortion tests to assure repeatability of all measurements.

4. When measuring hum and noise, all inputs should be disconnected from the amplifier and the level controls set to minimum or to maximum, preferably minimum.

5. Whenever possible avoid ground loops in the test equipment caused by connecting the output ground to the input ground. **Never** connect the ground of the cable going to the load back to the input ground.

Ground loops are especially obnoxious when measuring distortion. An I-M distortion analyzer, for example, has its input and output terminals tied to a common ground. Such a test should use an ungrounded output return, with the output lead(s) wrapped around the well-shielded and grounded input cable.

6. Always monitor the test oscillator when measuring frequency response. Use a wide-band AC voltmeter; or use the same meter for both input and output level measurements, if the meter's frequency response is known not to be dependent on attenuator settings.

7. Accuracy in measuring voltages for computing wattage is critical. For example, a 2% voltage error together with a 1% resistance error can result in an error of 1.8 watts power into 8 ohms.

8. Residual distortion and noise levels should be fully known for all the test equipment in order to accurately evaluate the amplifier.

9. Never attempt to measure damping factor by placing abnormal loads on the output. D-F measurements taken during clipping, or any other form of overload, are meaningless. The preferred method is to apply an externally generated current to the output terminals and measure the resultant voltage at the terminals. A convenient current is one ampere — as the resultant voltage will read directly in ohms for $|Z_o|$. Damping Factor is defined as $\left| \frac{Z_L}{Z_o} \right|$, where $|Z_L|$ is typically 8 ohms. A convenient generator for the 1A. current is that amplifier channel not under test. A non-inductive resistance of 8 ohms — coupled between both channels' output ter-

minals — will provide 1A. when 8 volts are impressed across the resistor (by that channel not under test).

10. Never measure hum and noise when in the presence of strong magnetic fields. The amplifier should be at least 4 inches away from any large metallic objects or shield plates for a reading to be meaningful.

11. Noise measurements should be taken with a band-pass filter of 20-20KHz. For audio purposes the measurement of noise above 20KHz is meaningless.

4.3 SERVICE

Should service other than routine fuse replacement ever be required, it is recommended that the unit be returned to the factory in the original packing (or replacement, if damaged). For warranty service the machine must be returned to the factory or warranty stations. The CROWN warranty is detailed on page 10.

Because of the level of circuitry sophistication of the D-60, only the most competent technicians should be allowed to service it.

Many of the parts are standard items stocked by most supply houses. However, there are several which appear to be standard parts but are actually different. Although standard parts may be used in an emergency, best results will be with factory parts. A number of the parts are available only from CROWN.

When ordering parts, be sure to give the amplifier serial number as well as the part number and description. Rated firms will be billed, otherwise shipments will be C.O.D.

Before returning an amplifier to the factory for service, authorization must first be obtained from the service manager. All shipments must be sent by UPS or truck freight, prepaid and insured at total value. The factory will return your serviced unit by UPS or truck freight, collect, and will add C.O.D. charges in the event that the cost is not covered by registered warranty.

APPLICATION NOTES

APPLICATION NOTE 1

Evaluating the V-I (volt-ampere) needs of a load: Many loads exhibit large reactances (or energy storage), which limits a power amplifier's ability to deliver a maximum power. If a load stores energy, which in turn flows back into the amplifier, it is clear that the maximum power efficiency of the system is not being achieved. Power that flows back into a linear amplifier must necessarily be dissipated in the form of heat. A pure reactance is not capable of dissipating any power; therefore to drive such a load would only cause power amplifier heating.

In practice all loads exhibit some energy dissipation — however large their energy storage characteristics may be. The ideal coupling to any load is one that optimizes the desired dissipation component while minimizing the reactive or stored-energy component that is seen by the amplifier's output terminals.

In applications where the input is sinusoidal and of small proportional frequency deviation, a relatively stable load may be resonantly tuned to present a real value of impedance to the amplifier.

Any load, no matter how complex its behavior, has a V-I operating range which may be mapped by the following test.

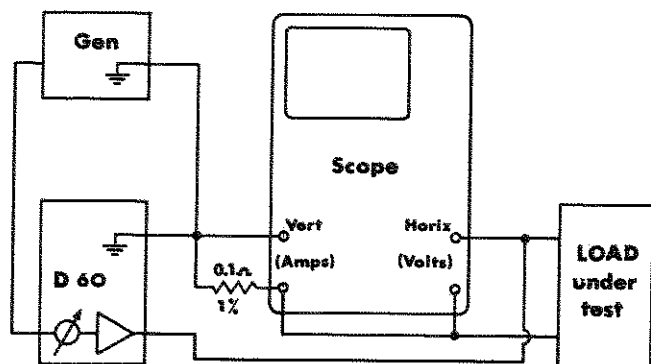

The maximum voltage and amperage excursions in all directions about zero (center of scope screen) define the volt-ampere operating range of the load. If a load is known to be linear over its operating range it is not necessary to supply the maximum desired power to the load. The test may be conducted at low signal levels and the current-sensing resistor (indicated as $0.1\ \Omega$) may be enlarged to a convenient value for the oscilloscope's deflection sensitivity. The resulting plot may be then linearly scaled to the desired operating level.

In the following example a reactive load is being fed a sinusoid of varying intensity. The V-I limits of the amplifier are super-imposed in dotted lines.

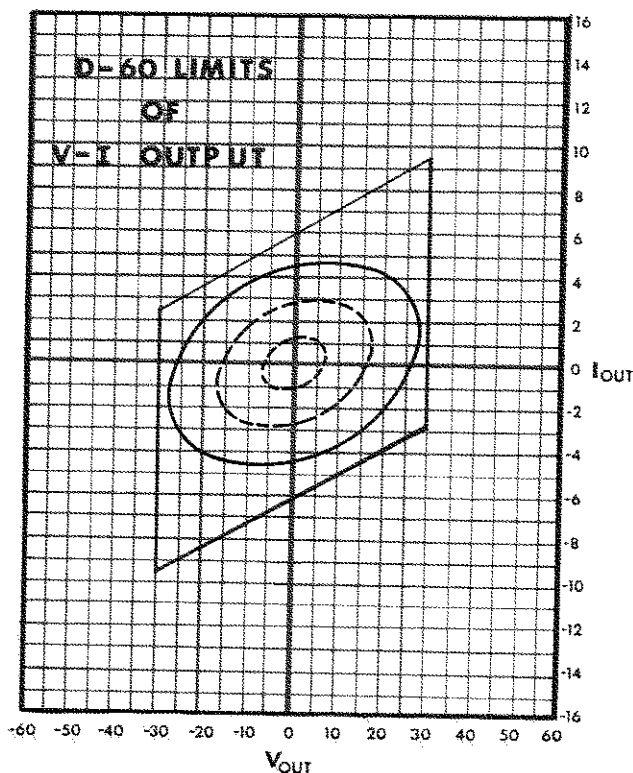

Handwritten title or header text.

Handwritten text block, likely a paragraph or list of notes.

Handwritten text block, possibly a list or detailed notes.

Handwritten text block, possibly a paragraph or list of notes.

Handwritten text block, possibly a paragraph or list of notes.

Handwritten text block, possibly a paragraph or list of notes.

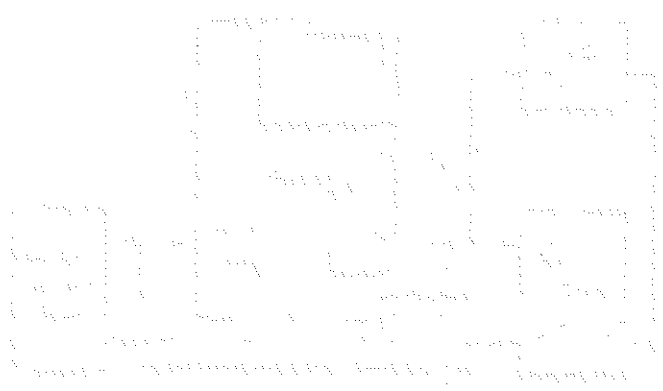

Handwritten text block, possibly a paragraph or list of notes.

APPLICATION NOTE NO. 2

WARNING

POWER AMPLIFIER PROTECTION SYSTEMS PROTECT AMPLIFIERS BUT NOT SPEAKERS! YOU, AND/OR YOUR SPEAKER MANUFACTURER ARE RESPONSIBLE FOR SPEAKER PROTECTION!

Except in unusual sets of circumstances, the circuitry included in power amplifiers designated as "protection", whether made up of transistor limiters, circuit breakers, fuses, SCR's, or whatever, is designed primarily to protect the amplifier from damage and will only protect speakers incidentally. There are some exceptions to this rule, which allow the user to vary the output power limits of his amplifier to match the power rating of his speakers. Even this, however, is a far from perfect speaker protection scheme. The reason why this holds true is simple: each make or model speaker has its own unique operating capabilities. As a rule, a speaker system (including all electronic parts such as crossover parts and electrostatic element transformers, as well as voice coils) will be able to dissipate a certain amount of power continuously without burning up. This depends on the size, quality, configuration, etc., of those parts. The same speaker will be able to handle a somewhat higher power level for a short period of time (in the millisecond range) without being destroyed by heat, but may then be endangered by such phenomena as extending moving elements beyond their normal range of travel (bottoming, torn diaphragm, etc.), overvoltageing electrostatic panels (arcing), or other such suddenly disabling events. Since the points at which these disastrous happenings will occur, differ for different speakers, a speaker protection system must be completely adjustable if it is to be useful for more than a narrow range of speakers. Furthermore, if the user is to be able to do adequate adjustment on a protection system external to his speakers, he must receive accurate information about the speaker power handling capabilities from the speaker manufacturer. Speaker protection systems embodied in amplifiers are comparatively useless, therefore, unless the following things are true:

- (1) The protection system can be accurately adjusted by the user.
- (2) The power handling capabilities of the speakers are clearly stated by the manufacturer.
- (3) The information about the speaker protection and speaker power handling are stated in common terms so that the user can adjust the protection properly for the speaker.

These three things are rarely true simultaneously. It is for this reason that CROWN takes the approach that speaker protection is the responsibility of the speaker manufacturer. Amplifier manufacturers have long been required to provide protection in their products for any faults occurring externally to the amplifier outputs, such as speaker short circuits, open circuits, etc. In order to fairly share the responsibility, and since the protection cannot be exhaustively provided any other way, we feel that speaker manufacturers should provide protection tailored to their individual products. At CROWN we have done this with our own speakers, simply because it is the only comprehensive means of providing worthwhile protection for all of our speakers.

Increasing power available from modern amplifiers increases the danger of speaker damage. Although occasionally an internal amplifier malfunction can contribute to speaker failure, it is much more likely that speakers will be overpowered by inadvertent use of too much power. In the absence of internal protection in most speaker systems, CROWN recommends very strongly that in-line speaker fuses be employed in all systems. The fuse selection nomograph reprinted in each CROWN amplifier manual can be an invaluable help in choosing fuses of the proper size. However, the effectiveness of fuses in protecting speakers is limited in two important ways:

- (1) Fuses as a rule protect only against prolonged overpowering, and can only prevent speakers from being driven with more than their RMS or average power rating. Fuses cannot protect against sudden high level transients of short duration. The use of high-speed instrument fuses will give the best protection available from fuses, but musical transients can have an effect before the fastest fuses blow.
- (2) An appropriate fuse can only be selected if the manufacturer's specifications for his speaker are accurately and clearly stated. If a speaker can handle 100 watt peaks and 30 watts continuously, but is advertised, and therefore fused, as a 100 watt speaker, then the speaker will destroy itself before the fuse can protect it under a continuous power level above 30 watts.

My dear Mother
I received your kind letter of the 19th and was glad to hear from you and to hear that you were all well. I am well at present and hope these few lines will find you all the same.

I have not much news to write at present. I am still in the same place and doing the same work. I have not seen any of my friends here and I have not heard from any of them since I left home.

I have not much news to write at present. I am still in the same place and doing the same work. I have not seen any of my friends here and I have not heard from any of them since I left home.

I have not much news to write at present. I am still in the same place and doing the same work. I have not seen any of my friends here and I have not heard from any of them since I left home.

I have not much news to write at present. I am still in the same place and doing the same work. I have not seen any of my friends here and I have not heard from any of them since I left home.

I have not much news to write at present. I am still in the same place and doing the same work. I have not seen any of my friends here and I have not heard from any of them since I left home.

I have not much news to write at present. I am still in the same place and doing the same work. I have not seen any of my friends here and I have not heard from any of them since I left home.

I have not much news to write at present. I am still in the same place and doing the same work. I have not seen any of my friends here and I have not heard from any of them since I left home.

I have not much news to write at present. I am still in the same place and doing the same work. I have not seen any of my friends here and I have not heard from any of them since I left home.

I have not much news to write at present. I am still in the same place and doing the same work. I have not seen any of my friends here and I have not heard from any of them since I left home.

I have not much news to write at present. I am still in the same place and doing the same work. I have not seen any of my friends here and I have not heard from any of them since I left home.

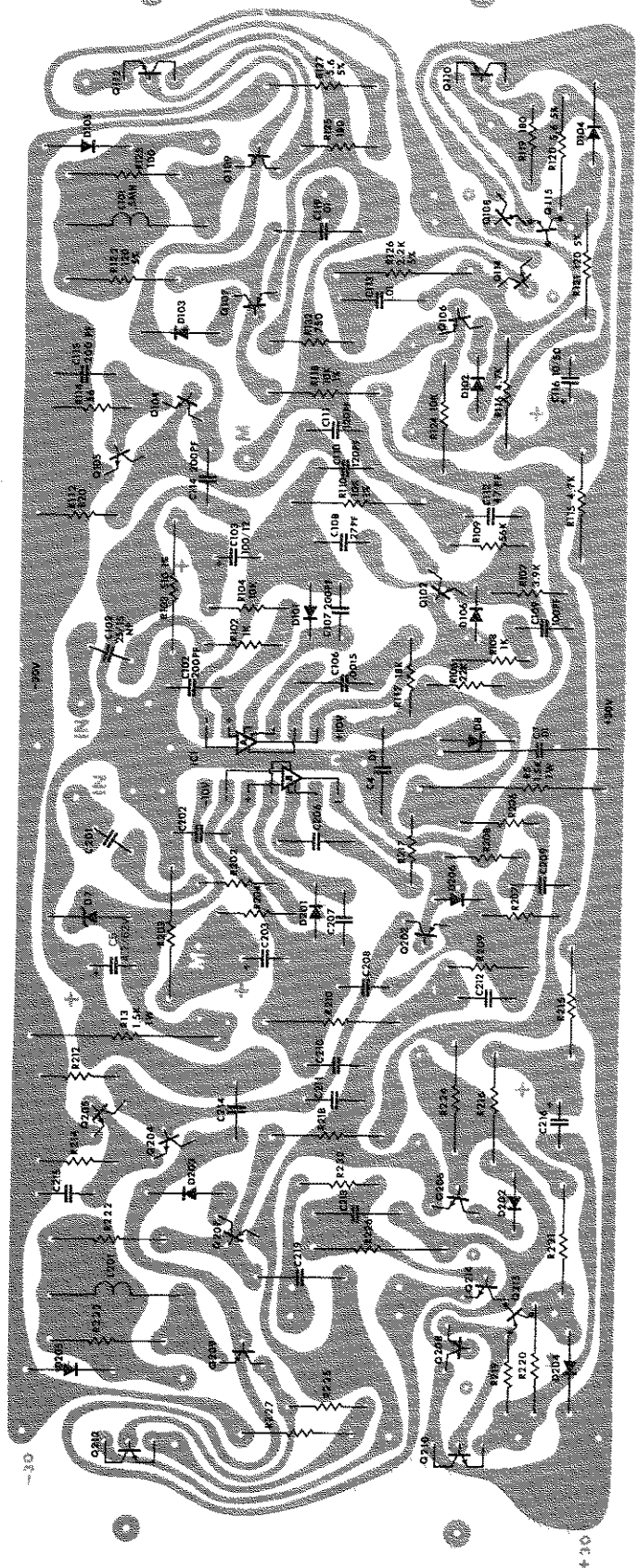

NOTES:

- THIS CIRCUIT STARTS SN 12751, AND APPLIES TO SCHEMATIC MI-247C, MI-247D.
- C7 ADDED SN16,776. Q115, Q215 ADDED SN 17526.
- SCHEMATIC DESIGNATIONS PRECEDED BY 1 ARE LEFT CHANNEL; BY 2, RIGHT CHANNEL.
- VALUES SHOWN ONLY FOR LEFT CHANNEL.

Handwritten notes on the left side of the page, including a vertical line of text and some illegible scribbles.

Main body of handwritten text, consisting of several paragraphs of dense, cursive writing.

Small handwritten mark or symbol in the top right corner.

Small handwritten mark or symbol in the middle right side.

Small handwritten mark or symbol in the bottom right corner.

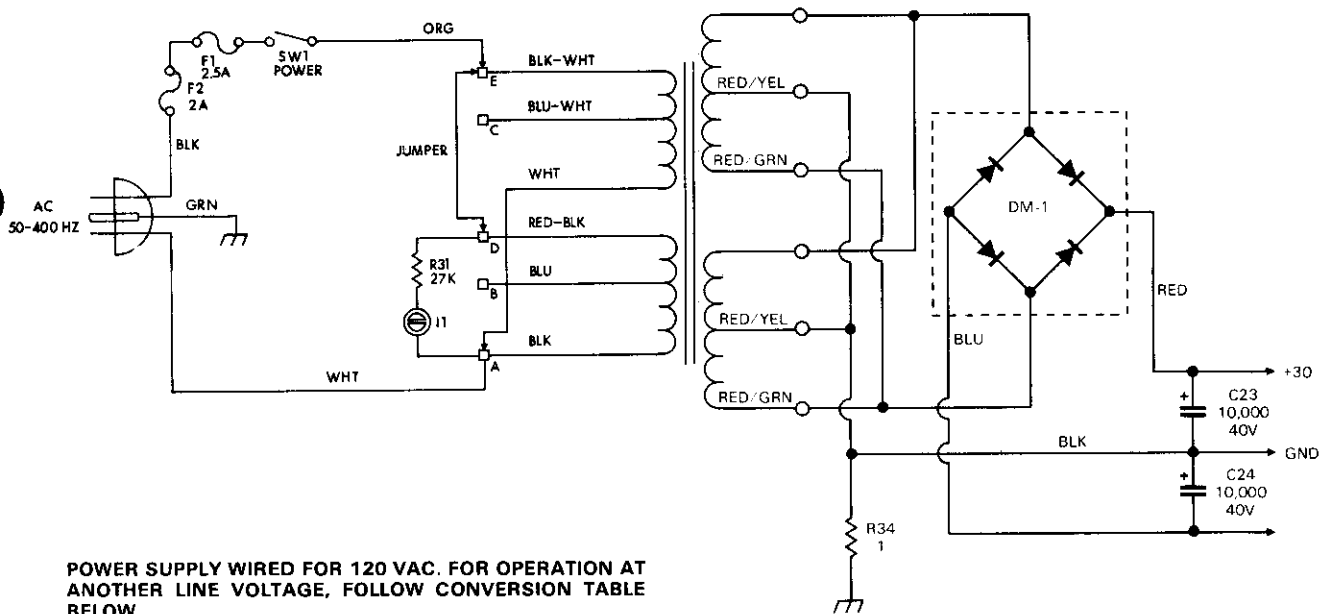

POWER SUPPLY WIRED FOR 120 VAC. FOR OPERATION AT ANOTHER LINE VOLTAGE, FOLLOW CONVERSION TABLE BELOW.

SELECT THE CORRECT VOLTAGE; CAREFULLY IDENTIFY ALL WIRES BEFORE PROCEEDING.

NOTE:

- ALL SIX TRANSFORMER WIRES ARE SOLDERED TO AN ADJACENT TERMINAL STRIP (POINTS A, B, C, D, AND E). ONLY FOUR WIRES ARE USED FOR ANY VOLTAGE CONFIGURATION.
- THE JUMPER WIRE, THE ORG AC WIRE, AND THE WHT TRANSFORMER WIRE ARE ALL DRAWN WITH ARROWS. THESE ARE THE ONLY WIRES THAT MOVE.
- FOR OPERATION BELOW 200VAC, THE LINE FUSE F2, IS 2A; FOR 200VAC AND ABOVE, F2 IS 1A.

LINE VOLTAGE	JUMPER	ORG AC	WHT TRANSFORMER
100	B-C	C	A
120	D-E	E	A
200	NONE	C	B
220	NONE	C	D
240	NONE	E	D

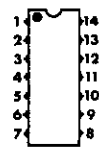
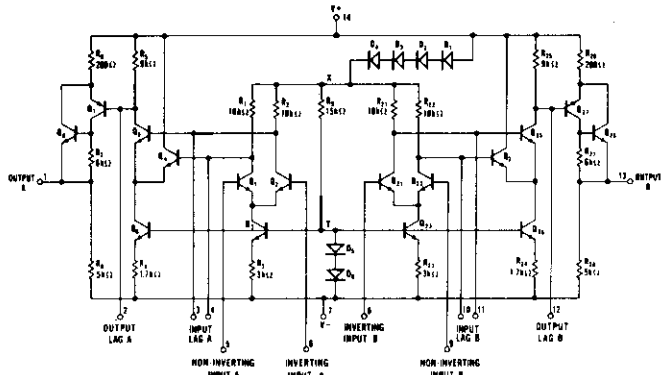

"IC" Pin Numbers (Top View)

NOTES:

- CIRCUIT SHOWN STARTS SN 12751, AND APPLIES ONLY TO P.C. BOARD #7925.
- POWER SUPPLY SHOWN STARTS SN 17,526.
- C6 WAS ADDED SN 13551; C7 ADDED 16,776.
- Q115, Q215 WAS ADDED SN 17526.
- TRANSISTORS Q114-Q108 AND Q214-Q208 ARE THERMALLY CONNECTED.
- ALL RESISTORS IN OHMS. ALL CAPACITORS IN MICRO-FARADS UNLESS OTHERWISE STATED.
- R135, R235 ARE 3.3K WHEN IC IS μ A749. WHEN IC IS μ A739, R135, R235 ARE OMITTED UNLESS INSTABILITY OCCURS. THEN RESISTORS ARE 10K.

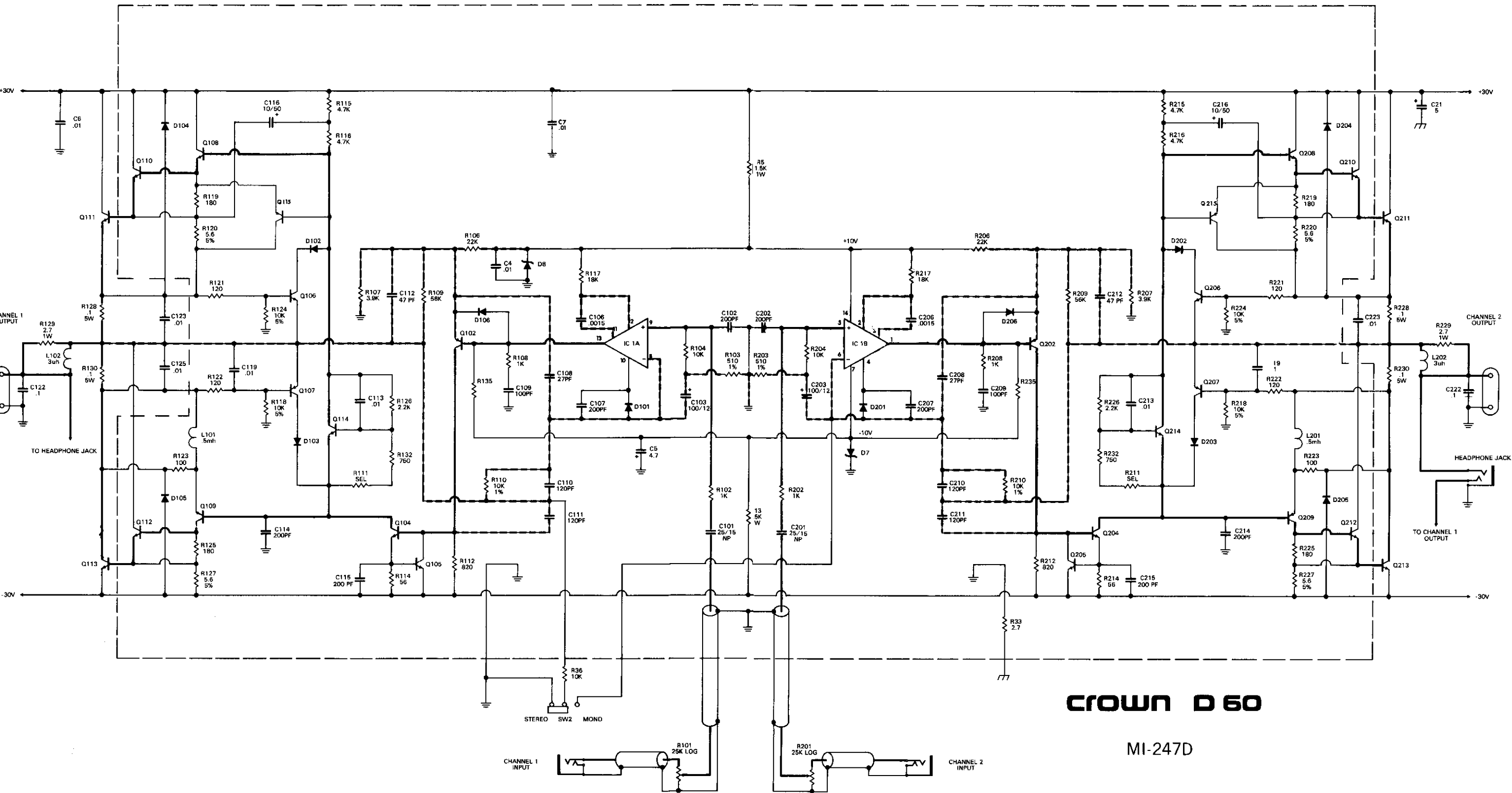

CROWN D 60
MI-247D