



Service Manual

SCS 8

Spatially Cued Surround Loudspeaker
2-Way Coaxial with 8" LF





Table of Contents

Datasheets and Specifications

Schematics

Bill of Materials



SCS 8

Spatially Cued Surround Loudspeaker

Key Features:

- Easy mounting system and ideal coverage allows for the SCS 8 to be the perfect loudspeaker for ceiling surround applications in immersive systems
- 250-watt power handling (2-hour AES, average continuous pink noise) and high sensitivity provide high SPL capability
- Consistent 120° x 120° broadband pattern coverage
- Extraordinarily clear cinema surround with extended frequency response for special effects
- Components:
 - 200 mm (8 in) woofer with Kevlar-reinforced cone and 50 mm (2 in) voice coil
 - 25 mm (1 in) exit compression driver with unique patented design and high-temperature polymer diaphragm
- 70 Hz – 20 kHz frequency response
- Coaxial 2-way design with high-power passive crossover network
- Overload protection



Description:

The SCS 8 Spatially Cued Cinema Surround is a full-range loudspeaker optimized for multi-channel surround formats and is designed for overhead or standard wall installations.

The SCS 8 is comprised of a high-power coaxial 200 mm (8 in) low frequency driver and 25 mm (1 in) high frequency compression driver. The coaxial design utilizes a unique tapered pole-piece design and transitions to the cone of the low frequency driver as a large diameter pattern control horn for the high frequencies, both eliminating high-frequency beaming and extending pattern control to the lowest possible frequencies. The result is a coaxial speaker with wide, extremely consistent 120° broadband coverage.

Component features include a Kevlar-reinforced low-frequency cone for reliability, well-damped surround edge for smooth frequency response, high-temperature 50 mm (2 in) voice coil and reduced distortion through saturated-gap magnet geometry. The high-frequency compression driver features a unique patented design, high-temperature polymer diaphragm and fluid cooling for high output levels with low distortion.

The enclosure is constructed of thick ABS and fiberglass and is heavily braced to maximize low-frequency performance. A heavy-duty U-type mounting bracket is included.

Specifications:

System:	
Frequency Range (-10 dB)	70 Hz – 20 kHz (4pi)
Frequency Response (±3 dB)	90 Hz – 20 kHz (4pi)
Coverage Pattern ¹	120° x 120°
Input Power Handling (AES 100-Hour Rating)	125 W (32.5 Vrms), pink/IEC
Input Power Handling (AES 2-Hour Rating)	250 W (44.7 Vrms), pink/IEC
Half-Space Sensitivity	94 dB, 1 W @ 1m, ref 2.83 V
Maximum SPL ²	118 dB (peaks of 124 dB) @ 1m
Crossover Network	2.1 kHz HF Filter: 3rd order (18 dB/oct) high-pass LF Filter: 2nd order (12 dB/oct) low-pass
Nominal Impedance	8 ohms
Minimum Impedance	5.3 ohms @ 190 Hz
Transducers:	
Low Frequency Driver	1 x C328, 200 mm (8 in) woofer, 50 mm (2 in) voice coil
High Frequency Driver	1 x 2414H-C, 25 mm (1 in) diaphragm and voice coil diameter, patented design, fluid-cooled
HF Driver Protection	Minimum audibility SonicGuard™ HF overload protection

Physical:	
Enclosure Construction	ABS and fiberglass, heavily braced
Attachment Options	2 x M10 points for included U-bracket M6 secondary safety attachment point on back panel
Grille Construction	Corrosion-resistant, zinc-rich steel
Input Connection	CE-compliant covered barrier strip terminals. Barrier terminals accept up to 9 mm outside 4 mm inside openlug (#6, #8 or #10) plus bare wire up to 2.5 mm ² (12 AWG) wire or spade lugs.
Dimensions (H x W x D)	300 x 300 x 305 mm (11.8 x 11.8 x 12.0 in) Depth with included U-bracket: 359 mm (14.2 in)
Colors	Black
Net Weight	8.2 kg (18 lb) With U-Bracket: 10 kg (22 lb)
Shipping Weight	11.4 kg (25 lb)
Included Accessories	Steel U-bracket

¹Average 1 kHz to 10 kHz.

²Calculated based on power rating and measured full-space sensitivity.

JBL continually engages in research related to product improvement. Some materials, production methods and design refinements are introduced into existing products without notice as a routine expression of that philosophy. For this reason, any current JBL product may differ in some respect from its published description, but will always equal or exceed the original design specifications unless otherwise stated.



SCS 8

Spatially Cued Surround Loudspeaker

Dimensions:

Dimensions in mm (inches)

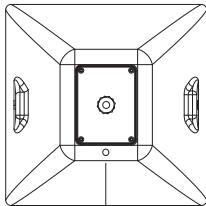
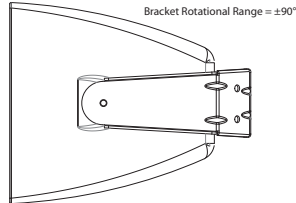
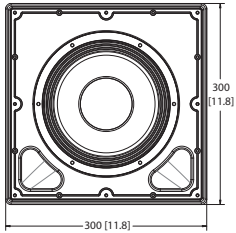
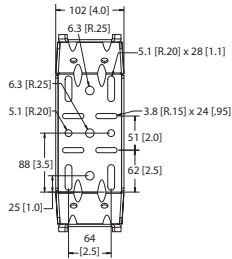
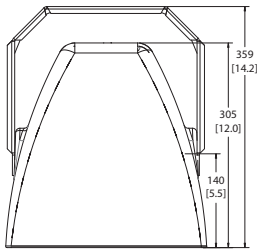

M6 secondary safety attachment point

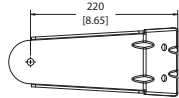
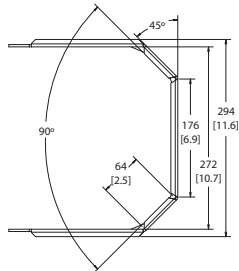

Graphs:

Frequency response in half-space (2π , solid line) and full-space (4π , dotted line)

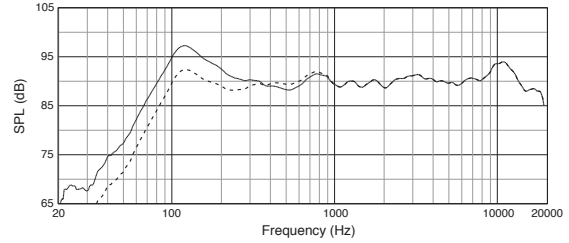

Beamwidth vs. Frequency

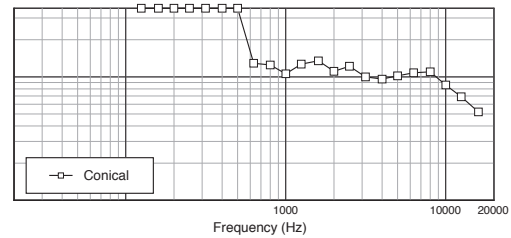

Off-Axis Frequency Response

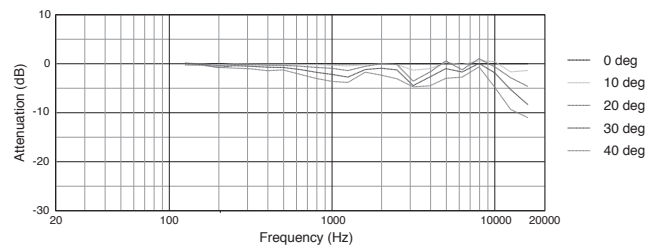

Attaching the U-Bracket to the Cabinet:

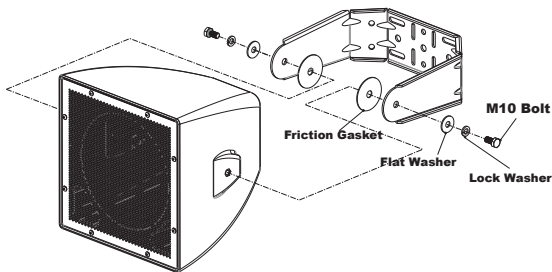

Impedance

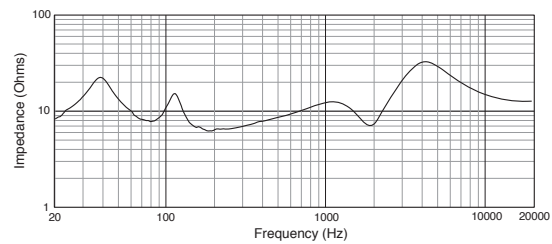

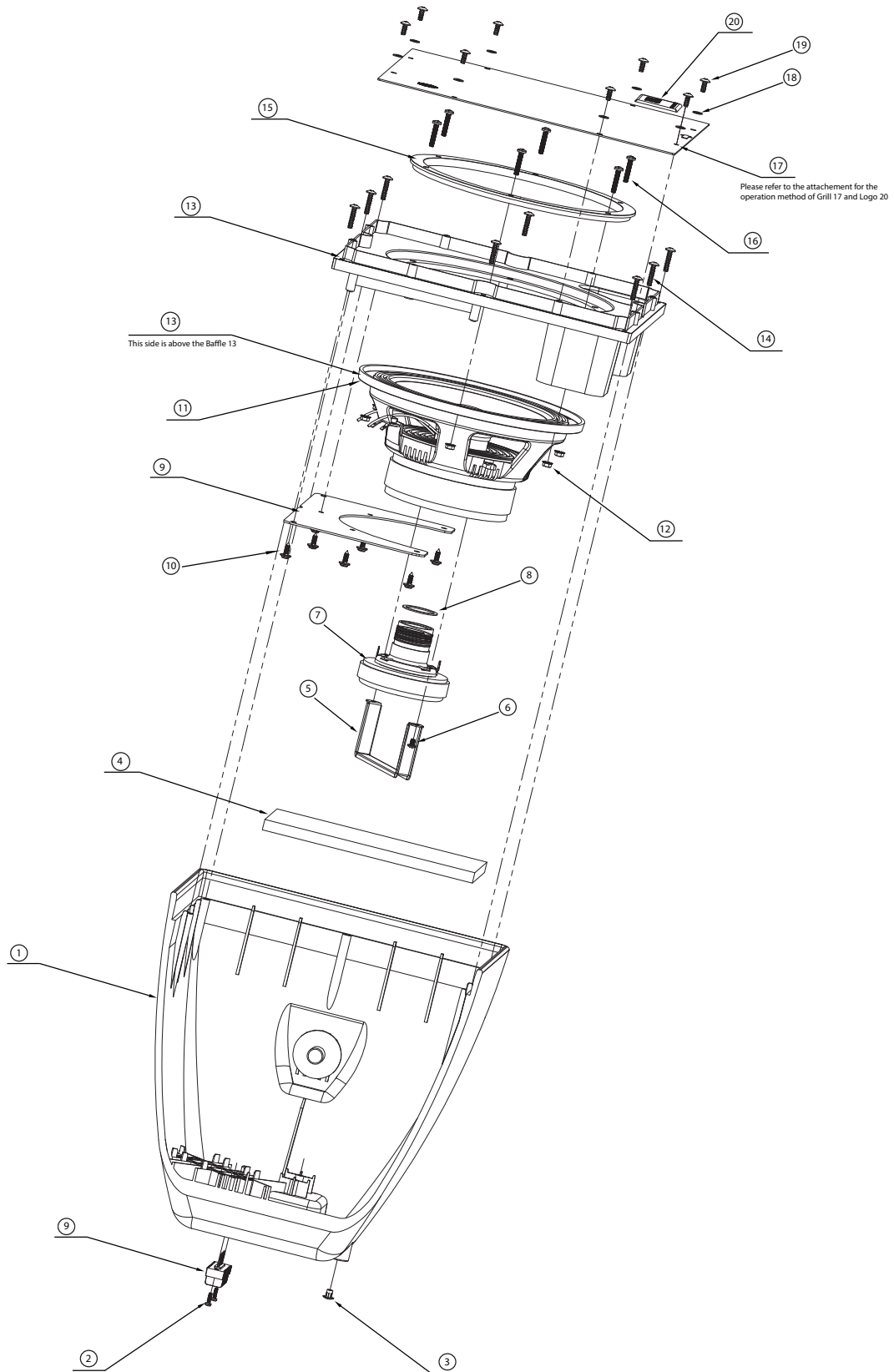

Refer to the corresponding Service Bill of Materials (SBOM) to order parts stocked by Harman.