

DISTRIBUTED IN NORTH AMERICA AS CROWN. EXPORTED AS AMCRON.®

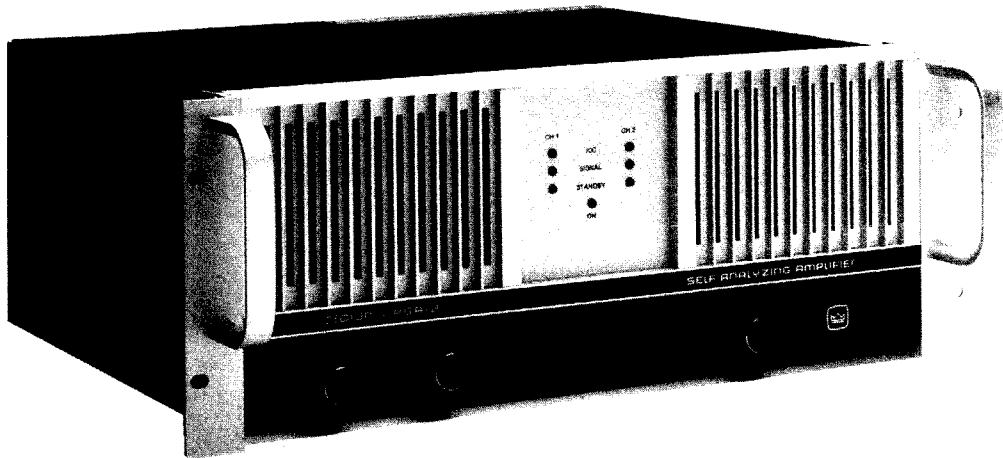

PSA-2X

PROFESSIONAL SELF-ANALYZING AMPLIFIER

OWNER'S MANUAL

©1991 by CROWN INTERNATIONAL, INC.

Mailing Address:
P.O. Box 1000
Elkhart, IN 46515-1000

Shipping Address:
57620 C.R. 105
Elkhart, IN 46517

Crown®, *Amcron*® and *IOC*® are registered trademarks of Crown International, Inc.



The body of this manual is
printed on recycled paper.

K80008D6
8/91

The information furnished in this manual does not include all of the details of design, production, or variations of the equipment. Nor does it cover every possible situation which may arise during installation, operation or maintenance. If you need special assistance, beyond the scope of this manual, please contact our Technical Services Department.

Crown/Amcron Technical Services Dept., P.O. Box 1000, Elkhart, Indiana 46515-1000
Phone: 800/342-6939 or 219/294-8200. Crown Fax: 219/294-8329. Amcron Fax: 219/294-8346

CAUTION

**RISK OF ELECTRIC SHOCK—DO NOT OPEN.
NO USER SERVICEABLE PARTS INSIDE.
REFER SERVICING TO QUALIFIED PERSONNEL.**

ATTENTION

**RISQUE DE CHOC ÉLECTRIQUE—
NE PAS OUVRIR**



WARNING

**TO REDUCE THE RISK OF ELECTRIC
SHOCK, DO NOT EXPOSE THIS
EQUIPMENT TO RAIN OR MOISTURE!**



FULL THREE-YEAR WARRANTY



SUMMARY OF WARRANTY

We, AMCRON, a division of Crown International, Inc., 1718 West Mishawaka Road, Elkhart, Indiana U.S.A. 46517-4095 warrant to you, the ORIGINAL PURCHASER and ANY SUBSEQUENT OWNER of each NEW Amcron product, for a period of three (3) years from the date of purchase by the original purchaser (the "warranty period") that the new Amcron product is free of defects in materials and workmanship, and we further warrant the new Amcron product regardless of the reason for failure, except as excluded in this Amcron Warranty.

ITEMS EXCLUDED FROM THIS AMCRON WARRANTY

This Amcron Warranty is in effect only for failure of a new Amcron product which occurred within the Warranty Period. It does not cover any product which has been damaged because of any intentional misuse, accident, negligence, or loss which is covered under any of your insurance contracts. This Amcron Warranty also does not extend to the new Amcron product if the serial number has been defaced, altered, or removed.

WHAT THE WARRANTOR WILL DO

We will remedy any defect, regardless of the reason for failure (except as excluded), by repair, replacement, or refund. We may not elect refund unless you agree, or unless we are unable to provide replacement, and repair is not practical or cannot be timely made. If a refund is elected, then you must make the defective or malfunctioning product available to us free and clear of all liens or other encumbrances. The refund will be equal to the actual purchase price, not including interest, insurance, closing costs, and other finance charges less a reasonable depreciation on the product from the date of original purchase. Warranty work can only be performed at our authorized service centers. We will remedy the defect and ship the product from the service center within a reasonable time after receipt of the defective product at our authorized service center. All expenses in remedying the defect, including surface shipping costs to the nearest authorized service center, will be borne by us. (You must bear the expense of all taxes, duties and other customs fees when transporting the product.)

HOW TO OBTAIN WARRANTY SERVICE

You must notify us of your need for warranty service not later than ninety (90) days after expiration of the warranty period. All components must be shipped in a factory pack. Corrective action will be taken within a reasonable time of the date of receipt of the defective product by our authorized service center. If the repairs made by our authorized service center are not satisfactory, notify our authorized service center immediately.

DISCLAIMER OF CONSEQUENTIAL AND INCIDENTAL DAMAGES

YOU ARE NOT ENTITLED TO RECOVER FROM US ANY INCIDENTAL DAMAGES RESULTING FROM ANY DEFECT IN THE NEW AMCRON PRODUCT. THIS INCLUDES ANY DAMAGE TO ANOTHER PRODUCT OR PRODUCTS RESULTING FROM SUCH A DEFECT.

WARRANTY ALTERATIONS

No person has the authority to enlarge, amend, or modify this Amcron Warranty. This Amcron Warranty is not extended by the length of time which you are deprived of the use of the new Amcron product. Repairs and replacement parts provided under the terms of this Amcron Warranty shall carry only the unexpired portion of this Amcron Warranty.

DESIGN CHANGES

We reserve the right to change the design of any product from time to time without notice and with no obligation to make corresponding changes in products previously manufactured.

LEGAL REMEDIES OF PURCHASER

No action to enforce this Amcron Warranty shall be commenced later than ninety (90) days after expiration of the warranty period.

THIS STATEMENT OF WARRANTY SUPERSEDES ANY OTHERS CONTAINED IN THIS MANUAL FOR AMCRON PRODUCTS.

Amcron, P.O. Box 1000, 1718 W. Mishawaka Rd., Elkhart, Indiana
U.S.A. 46515-1000. Phone: 219/294-8000. Fax: 219/294-8346.



FULL THREE-YEAR WARRANTY



SUMMARY OF WARRANTY

We, CROWN, a division of Crown International, Inc., 1718 West Mishawaka Road, Elkhart, Indiana U.S.A. 46517-4095 warrant to you, the ORIGINAL PURCHASER and ANY SUBSEQUENT OWNER of each NEW Crown product, for a period of three (3) years from the date of purchase by the original purchaser (the "warranty period") that the new Crown product is free of defects in materials and workmanship, and we further warrant the new Crown product regardless of the reason for failure, except as excluded in this Crown Warranty.

ITEMS EXCLUDED FROM THIS CROWN WARRANTY

This Crown Warranty is in effect only for failure of a new Crown product which occurred within the Warranty Period. It does not cover any product which has been damaged because of any intentional misuse, accident, negligence, or loss which is covered under any of your insurance contracts. This Crown Warranty also does not extend to the new Crown product if the serial number has been defaced, altered, or removed.

WHAT THE WARRANTOR WILL DO

We will remedy any defect, regardless of the reason for failure (except as excluded), by repair, replacement, or refund. We may not elect refund unless you agree, or unless we are unable to provide replacement, and repair is not practical or cannot be timely made. If a refund is elected, then you must make the defective or malfunctioning product available to us free and clear of all liens or other encumbrances. The refund will be equal to the actual purchase price, not including interest, insurance, closing costs, and other finance charges less a reasonable depreciation on the product from the date of original purchase. Warranty work can only be performed at our authorized service centers or at the factory. We will remedy the defect and ship the product from the service center or our factory within a reasonable time after receipt of the defective product at our authorized service center or our factory. All expenses in remedying the defect, including surface shipping costs in the United States, will be borne by us. (You must bear the expense of shipping the product between any foreign country and the port of entry in the United States and all taxes, duties, and other customs fees for such foreign shipments.)

HOW TO OBTAIN WARRANTY SERVICE

You must notify us of your need for warranty service not later than ninety (90) days after expiration of the warranty period. All components must be shipped in a factory pack, which, if needed, may be obtained from us free of charge. Corrective action will be taken within a reasonable time of the date of receipt of the defective product by us or our authorized service center. If the repairs made by us or our authorized service center are not satisfactory, notify us or our authorized service center immediately.

DISCLAIMER OF CONSEQUENTIAL AND INCIDENTAL DAMAGES

YOU ARE NOT ENTITLED TO RECOVER FROM US ANY INCIDENTAL DAMAGES RESULTING FROM ANY DEFECT IN THE NEW CROWN PRODUCT. THIS INCLUDES ANY DAMAGE TO ANOTHER PRODUCT OR PRODUCTS RESULTING FROM SUCH A DEFECT. SOME STATES DO NOT ALLOW THE EXCLUSION OR LIMITATIONS OF INCIDENTAL OR CONSEQUENTIAL DAMAGES, SO THE ABOVE LIMITATION OR EXCLUSION MAY NOT APPLY TO YOU.

WARRANTY ALTERATIONS

No person has the authority to enlarge, amend, or modify this Crown Warranty. This Crown Warranty is not extended by the length of time which you are deprived of the use of the new Crown product. Repairs and replacement parts provided under the terms of this Crown Warranty shall carry only the unexpired portion of this Crown Warranty.

DESIGN CHANGES

We reserve the right to change the design of any product from time to time without notice and with no obligation to make corresponding changes in products previously manufactured.

LEGAL REMEDIES OF PURCHASER

THIS CROWN WARRANTY GIVES YOU SPECIFIC LEGAL RIGHTS. YOU MAY ALSO HAVE OTHER RIGHTS WHICH VARY FROM STATE TO STATE. No action to enforce this Crown Warranty shall be commenced later than ninety (90) days after expiration of the warranty period.

THIS STATEMENT OF WARRANTY SUPERSEDES ANY OTHERS CONTAINED IN THIS MANUAL FOR CROWN PRODUCTS.

Crown, P.O. Box 1000, 1718 W. Mishawaka Rd., Elkhart, Indiana U.S.A. 46515-1000.
Phone: 219/294-8000. Crown Fax: 219/294-8329, Amcron Fax: 219/294-8346.

CONTENTS

1	Welcome	1-1
	1.1 Unpacking	1-1
	1.2 Features	1-1
2	Facilities	2-1
3	Installation	3-1
	3.1 Mounting	3-2
	3.1.1 Preventing Ground Loops	3-2
	3.2 Cooling	3-2
	3.3 Wiring	3-2
	3.3.1 Mode of Operation	3-3
	3.3.2 Input	3-3
	3.3.3 Output	3-4
	3.3.4 Load Protection	3-5
	3.3.5 Inductive Loads	3-5
	3.3.6 Power	3-5
	3.3.7 Converting Voltages	3-5
4	Operation	4-1
	4.1 Precautions	4-1
	4.2 Front Panel Displays	4-1
	4.3 Controls	4-1
	4.4 Protection	4-1
	4.5 Cleaning	5-1
5	Service	5-1
	5.1 Service at a Crown Service Center	5-1
	5.2 Factory Service	5-1
6	Technical Information	6-1
	6.1 Overview	6-1
	6.2 Circuit Theory	6-1
7	Specifications	7-1
	7.1 Performance	7-1
	7.2 Power	7-1
	7.3 Controls	7-1
	7.4 Indicators	7-1
	7.5 Input/Output	7-1
	7.6 Protection	7-2
	7.7 Construction	7-2
8	Balanced Input Module	8-1
	8.1 Features	8-1
	8.2 Circuit Theory	8-4
	8.3 Specifications	8-4

ILLUSTRATIONS

1.1	PSA-2X Amplifier	1-1
2.1	Front Facilities	2-1
2.2	Rear Facilities	2-2
3.1	System Connection for Stereo and Mono	3-1
3.2	Mounting Dimensions	3-2
3.3	Input Capacitor Selection	3-3
3.4	Unbalanced RFI Filters	3-3
3.5	Wire Size Nomograph	3-4
3.6	Fuse Selection for Loudspeaker Protection	3-5
6.1	Circuit Block Diagram	6-2
7.1	PSA-2X Power Matrix	7-3
7.2	Typical Frequency Response	7-4
7.3	Typical Output Phase Response	7-4
7.4	Typical Crosstalk	7-4
7.5	Typical IM Distortion	7-5
7.6	Typical Noise Spectrum	7-5
7.7	Typical Damping Factor (8 ohm)	7-6
7.8	Typical Power Output: 16, 8, 4 and 2 ohm	7-6
7.9	Typical Output Impedance	7-7
7.10	Typical Low-Frequency Protect Action	7-7
8.1	Balanced Input Module	8-1
8.2	Low/High Pass Conversions Formulas	8-2
8.3	AGC Threshold Control Positions	8-3
8.4	Typical Freq Response, Balanced Input Mod	8-5
8.5	Typical CMR Through Balanced Input Mod	8-5
8.6	Typical AGC Action	8-5

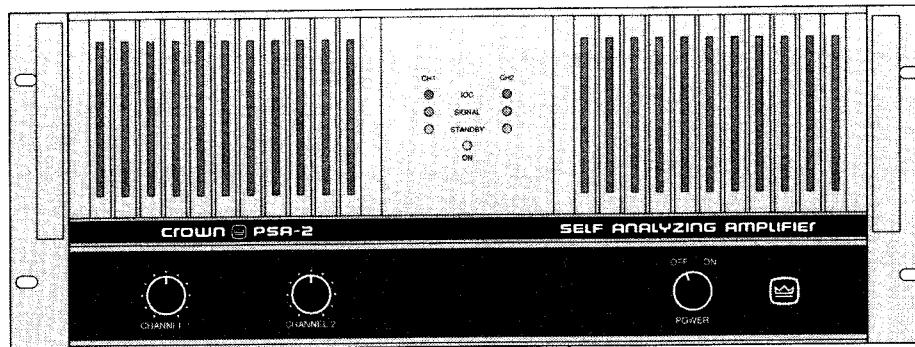

Fig. 1.1 PSA-2X Amplifier

1 Welcome

Congratulations on your purchase of the PSA-2X professional self-analyzing power amplifier. The PSA-2X is designed for precision amplification, high power output, and dependable performance in demanding professional use.

It incorporates unique on-board analog computers to monitor the *safe operating area (SOA)* of its output transistors to provide higher power without the arbitrary voltage or current restrictions of most amplifiers. The result: maximum output as well as maximum safety.

Crown has engineered your new amplifier for high reliability, using only the finest materials and protecting your investment with the most comprehensive three-year warranty in the music industry.

This manual will help you successfully install and use your PSA-2X amplifier. In order to gain maximum benefit from your amp we strongly recommend you read all the instructions, warnings and cautions contained within. Also for your protection, please send in your warranty registration card today and save your bill of sale since it is your **official proof of purchase**.

1.1 Unpacking

Please unpack and inspect your new amplifier for any damage that may have occurred during transit. If damage is found, notify the transportation company immediately. Only you, the consignee, may initiate a claim with the carrier for damage resulting during shipment. Crown will be happy to cooperate fully as needed. Save the shipping carton as evidence of damage for the shipper's inspection.

Even if the unit arrived in perfect condition, as most do, save all packing materials so you will have them if you ever need to transport the unit. **NEVER SHIP THE UNIT WITHOUT THE FACTORY PACK.**

You should find these items when you unpack:

- 1 15 A-20 Amp AC adapter
- 4 mounting screws
- 4 nylon washers

1.2 Features

- Front panel of extra rugged extruded aluminum features Signal Presence, Standby, and IOC® indicators as well as level controls for each channel.
- Stereo-Mono switch on back panel allows quick conversion from stereo mode to bridged-mono mode for higher-powered single-channel operation.
- IOC (Input/Output Comparator) circuitry immediately alerts of any distortion over 0.05%.
- Patented Crown circuitry handles extreme voltage swings without putting output transistors in series, resulting in lower distortion, greater reliability.
- Very low harmonic and intermodulation distortion give best *dynamic transfer function* in the industry.
- Full protection against shorted outputs, open circuits, mismatched loads, general overheating, and high-frequency overloads.
- Separate voltage supplies for each channel provide excellent crosstalk characteristics as well as provide improved reliability.
- Efficient heat sinks and a self-contained forced air cooling system prevent overheating and prolong component life.
- Mounts in a standard 19-inch (48.3 cm) equipment rack; also can be stacked on its rubber feet.

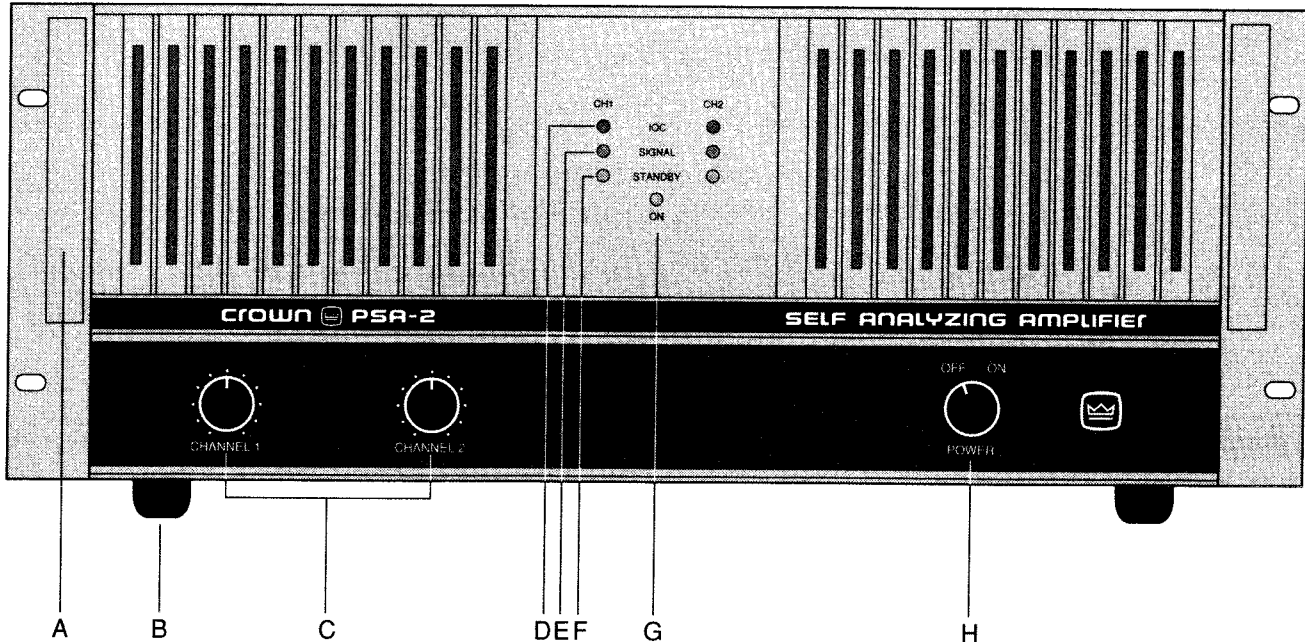

Fig. 2.1 Front Facilities

2 Facilities

A. Front Panel

Rugged satinized aluminum panel with rack mount holes and sturdy handles.

B. Rubber Feet

Removable heavy-duty rubber feet permit stacking of amplifiers.

C. Level Controls

Separate level controls for each channel.

D. *IOC*[®] Indicators

Red LEDs show *Input/Output Comparator (IOC)* status for each channel. The LEDs light up when the output waveform differs from the input waveform by more than 0.05%. Factors which can cause such distortion are too high an input level and improper load impedance.

(NOTE: occasional flashing of *IOC* after turn-off is normal; also, *IOC* and Signal Presence indicators will NOT illuminate simultaneously.)

E. Signal Indicators

Green LEDs indicate signal presence of at least 1.2 peak volts at the output of that respective channel. Under normal operation, the Signal lights will be on.

F. Standby Indicators

Yellow LEDs glow when either channel is in the standby state. This will occur when utilizing the DELAY feature.

G. Power On Indicator

Amber LED indicates the presence of AC power. The power switch engages only the cooling system and low-voltage power supply.

H. Power Switch

A two-position switch turns the unit on and off.

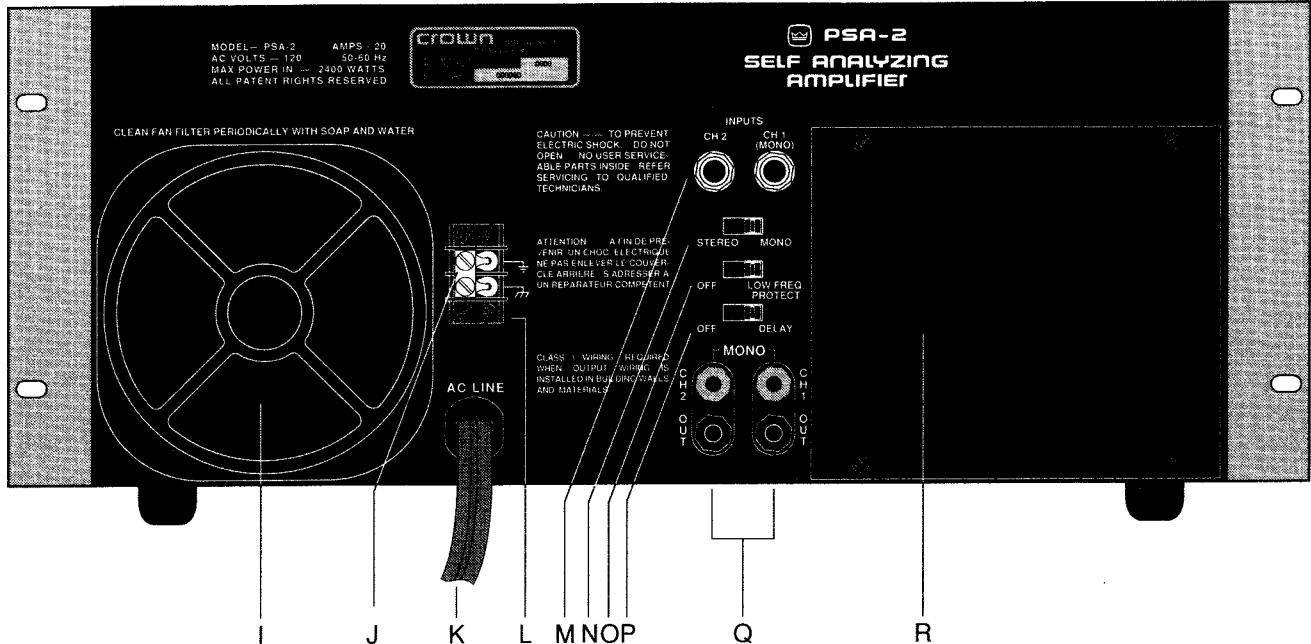

Fig. 2.2 Rear Facilities

I. Fan Intake

The PSA-2X has a dust filter on the air intake to the cooling system. The filter may be removed for cleaning.

J. Shorting Strap

Isolation of chassis ground from signal ground is easily accomplished by removing the shorting strap from the terminal strip. This may correct hum problems caused by ground loops.

K. Power Cord

20-amp power cord with standard three-wire grounded connector.

L. Ground Barrier Strip

2-lug terminal block with removable shorting strap provides a means for isolating or uniting chassis and signal grounds.

M. Input Jacks

Unbalanced 1/4-inch phone jacks are provided for input.

N. Stereo-Mono Switch

Slide left for Stereo operation, right for Bridged Mono.

O. Low Frequency Protect Switch

Engaging this switch causes the unit to cycle through the "STANDBY" mode if low frequency (DC-10 Hz) appears at the output.

Caution: Whenever the LOW FREQ PROTECT switch is engaged, also engage the DELAY switch.

P. Delay Switch

This switch activates a four-second delay in the transition state from "turn-on" to high-voltage power supplies on.

Q Output Connectors

Banana jacks are provided at the output of each channel. It is recommended that banana plugs be used on the loudspeaker cables for connection to the output jacks.

R. Cover Plate

Allows installation of optional Balanced Input Module (PSA-2 MOD). See Section 8 for details.

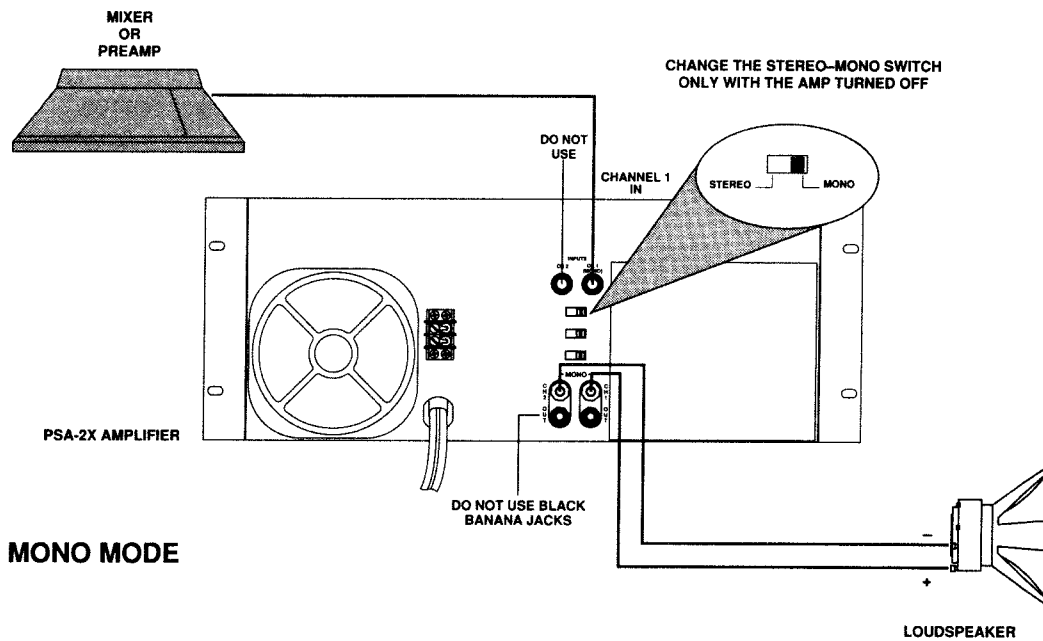
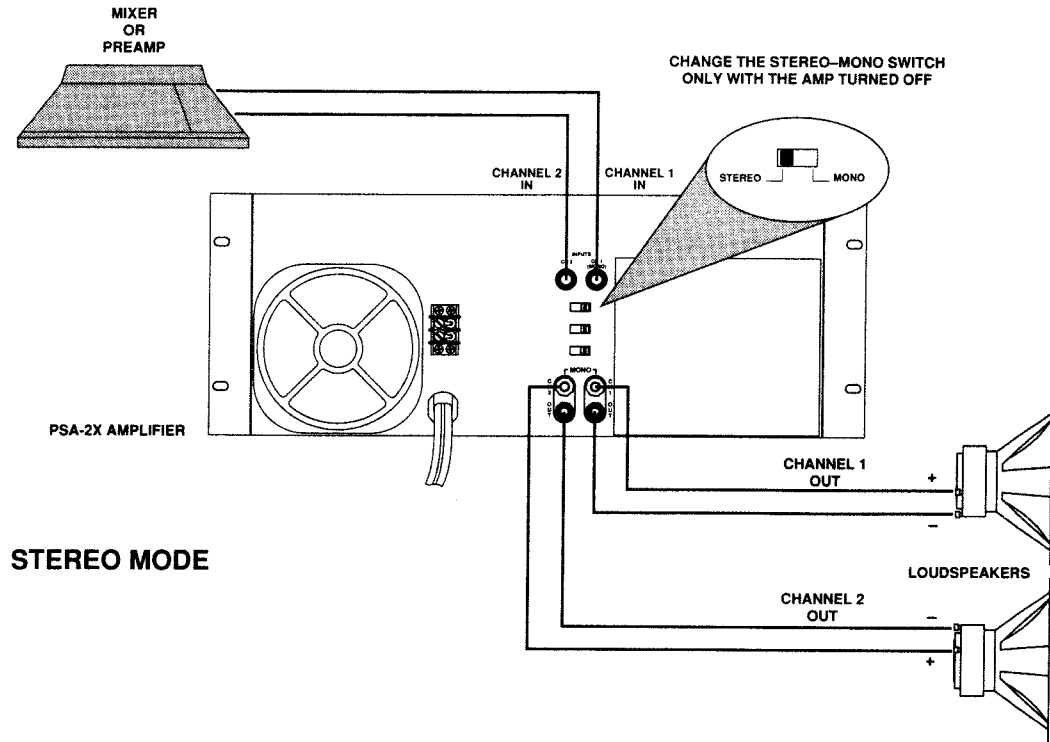

Fig. 3.1 System Connection for Stereo and Mono Operation

3 Installation

3.1 Mounting

The PSA-2X amplifier is designed for standard 19-inch (48.3 cm) rack mounting as well as stack mounting without a cabinet. Please pay close attention to the cooling requirements (see Section 3.2).

When rack mounting is chosen, take care to protect the amplifier if the rack is likely to be subjected to usage that could result in mechanical shock.

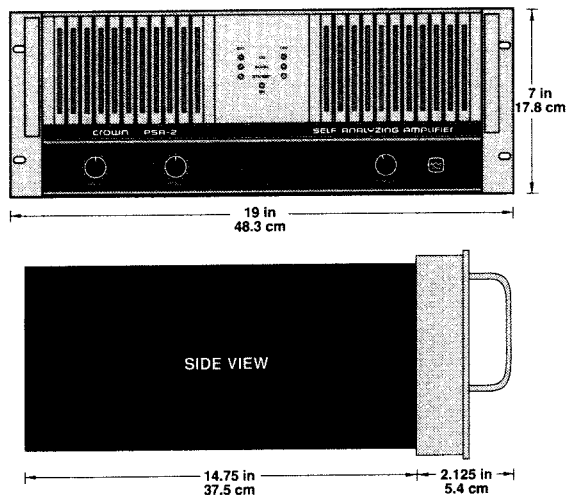

Fig. 3.2 Mounting Dimensions

Important: Because of the weight of the unit, the rear should be securely supported.

The simplest form of support is to use end supporting angles joined to the sides of the rack. These support the amplifier from beneath. If chassis slides are used, care should be taken to avoid toppling the rack when the slides are extended. The center of gravity of the amplifier is approximately 5.4 inches (13.7 cm) behind the front panel.

3.1.1 Preventing Ground Loops

If a number of units are being racked on electrically common rails, and a very high signal/noise ratio is to be maintained, it may be necessary to separate the chassis ground from the signal ground. Do this by removing the strap from the rear-panel ground-terminal strip. This will reduce the possibility of ground loop hum.

3.2 Cooling

NEVER block the air vents in the sides, front, and back of the amplifier. A clearance of 1.75 inches (4.5 cm) should be allowed above the unit for hot air discharge.

A source of cooling air should be provided for the fan intake. A vent tube to the outside of the rack may be necessary if the rack ventilation is poor and/or the amplifier heat output is high. Never install the amp in a small unventilated cabinet; automatic thermal derating or transformer shutdown will occur after prolonged operation under such conditions.

If the air supply is unusually dusty, you will want to pre-filter it using commercial furnace filters, etc., to prevent rapid loading of the unit's own air filter. When needed, the unit's filter can be cleaned with mild detergent and water (see Section 4.5).

3.3 Wiring

Figure 3.1 shows how to install a PSA-2X amplifier into a sound system for either STEREO or MONO operation. Please use care in making connections, selecting signal sources and controlling the output level.

It is always wise to remove power from the unit and turn the input level controls off while making or changing connections—especially if the load is a loudspeaker system. This will eliminate any chance of loud blasts or damage to the loudspeakers. The load you save may be your own! Crown assumes no liability for damaged loads resulting from careless amplifier use and/or deliberate overpowering.

Input Wiring Tips

1. Use only shielded cable. The higher the density of the shield (the outer conductor), the better the cable. Spiral wrapped shield is not recommended.
2. When using unbalanced lines, keep the cables as short as possible. Avoid cable lengths greater than 10 feet (3 meters).
3. Do not run signal cables together with high-level wiring such as loudspeaker wires or AC cords. (This greatly lessens the chance of hum or noise being induced or picked up from asymmetrical ground loops.)
4. Turn the entire system off before changing any connections and turn the Level control all the way down before powering the system back up. Crown is not liable for damage incurred when any transducer or component is overdriven.

3.3.1 Mode of Operation

The PSA-2X may be operated in STEREO or BRIDGED MONO by switching the stereo/mono slide switch on the rear panel. There are VERY IMPORTANT wiring differences between these modes which are detailed next.

STEREO

The installation is very intuitive in STEREO mode. The Channel 1 input signal is amplified at the Channel 1 output. The same is true of Channel 2. To put the amplifier into STEREO mode, first turn the amplifier off, then slide the Stereo-Mono switch to the STEREO position, and properly connect the output wiring. Observe correct loudspeaker polarity (see the first example in Figure 3.1) and be very careful not to short the two outputs together while in STEREO mode.

CAUTION: Never parallel the two outputs by directly tying them together or paralleling them with the output of any other amplifier. Such connection does not result in increased power output and can cause premature activation of the protection circuitry to prevent overheating.

MONO

When the switch is in the MONO position, the input circuitry of the PSA-2X is altered so that the two channels are "added" (bridged) for mono output.

Care must be taken in the external hook-up to assure proper operation. Observe the following:

1. Plug the input line into the Channel 1 input jack. The level is adjusted with the Channel 1 level control only. Unplug the input to Channel 2 and completely turn down the Channel 2 level control (CCW).

Note: the Channel 2 input jack and level control are not defeated in the MONO mode. **DO NOT USE THE CHANNEL 2 INPUT OR THE SIGNAL LEVEL AND QUALITY MAY BE GREATLY DEGRADED.**

2. Connect the load across the two red banana posts with the positive lead from the load attaching to the red post of Channel 1 and the negative lead of the load attaching to the red post of Channel 2 (see the second example in Figure 3.1).

Because of the panel mounting configuration of the dual banana output jacks, it is possible to use only one banana plug. Both load leads are connected to the red connectors only. **THE TWO BLACK BANANA OUTPUT POSTS ARE NOT USED AND SHOULD NOT BE SHORTED. The load must be balanced** (neither side shorted to ground).

CAUTION: All equipment (meters, switches, etc.) connected to the mono output lines must be balanced. To prevent oscillations, isolate both sides of the line from the input grounds.

3.3.2 Input

Unbalanced 1/4-inch phone input jacks are provided for each channel on the rear panel. When you connect the inputs, take precautions to prevent problems in three areas: 1) undesirable signals to the inputs, 2) ground loops, and 3) feedback from output(s) to input(s).

Large **subsonic (subaudible) frequencies** are sometimes present in the input signal and can overload, overheat or otherwise damage loudspeakers.

A simple visual test for DC on the inputs (providing the woofer is visible) is to slowly turn up the input level control with the amp on and watch for displacement of the loudspeaker cone. If much displacement is observed, the DC content of the input may be excessive.

To remove such frequencies, place a capacitor in series in the input signal line. The graph in Figure 3.4 shows how the value of the capacitor affects the frequency response. Use only a low-leakage paper, mylar or tantalum capacitor.

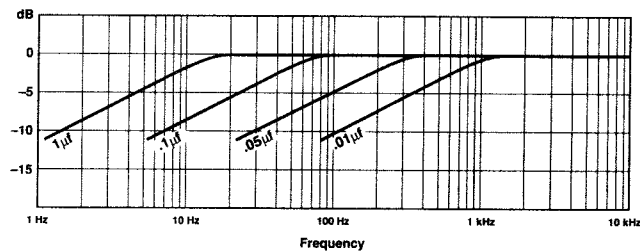
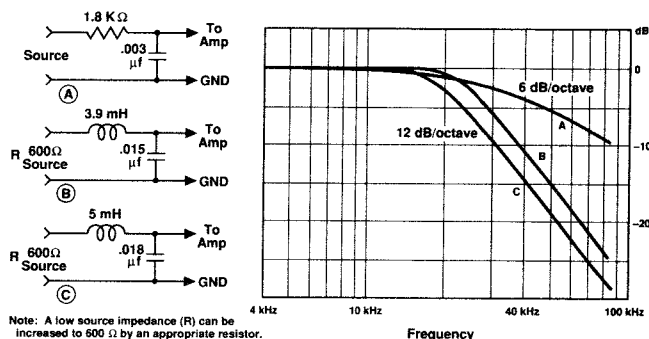

Fig. 3.3 Input-Capacitor Selection

If large amounts of **ultrasonic frequencies** or RF (radio frequency) are found on the input, such as bias from tape recorders, radio stations, etc., put a low-pass filter on the input.

While the highest RF levels that can be reasonably expected may not damage the amplifier, they can burn out tweeters or other sensitive loads, activate the amplifier's protection system or overload the controlled-slewing-rate stage of the amp. (This stage provides RF overload protection.)

The following filters are recommended for such situations:



Note: A low source impedance (R) can be increased to 600 Ω by an appropriate resistor.

Fig. 3.4 Unbalanced RFI Filters

Another problem to prevent is **ground loops**—undesirable currents flowing in a grounded system, possibly causing hum in the output. A common form of loop is a pair of input cables whose area is subjected to a magnetic hum field. To prevent ground loops causing magnetic induction, lace both cables together along their length and keep them away from the power transformer. **DO NOT CONNECT THE INPUT AND OUTPUT GROUNDS TOGETHER.**

Feedback oscillation can occur when input and output grounds are tied together as in testing or metering. When the amp is driving an AC-grounded device such as a meter, follow this procedure. For safety, plug all the devices' 3-prong AC plugs into grounded outlets. Then, to break up the ground loop, disconnect the cable shield from the output of the device driving the amp input.

To isolate the signal ground from the AC (chassis) ground, remove the ground shorting strap between the ground terminals on the rear panel (Fig. 2.2).

3.3.3 Output

Consider the power handling capacity of your load before connecting it to the amplifier. Crown is not liable for damage incurred at any time due to the load being overpowered. The use of loudspeaker protection fuses is highly recommended (see Section 3.3.4). Please also pay close attention to the Operating Precautions (Section 4.1).

Use speaker cables of sufficient gauge (thickness) for the length used. Otherwise, power is lost through cable heating and the damping factor decreased due to cable resistance. Refer to the nomograph (Fig. 3.6) for wire size.

Use the nomograph as follows:

1. Note the load resistance of the speakers connected to each channel of the amplifier. Mark this value on the nomograph "Load Resistance" line.
2. Choose an acceptable system damping factor (50 is typical). Mark this value on the "Damping Factor" line.
3. Draw a pencil line through these two points, intersecting the "Source Resistance" line.
4. On the "2-Cond. Cable" line, mark the length of cable run.
5. Draw a pencil line from the intersection point on the "Source Resistance" line through the mark on the "2-Cond. Cable" line.
6. Note where the pencil line intersects the "Annealed Copper Wire" line. This value is the required gauge of speaker cable.
7. If the cable size exceeds what you want to use, settle for a lower damping factor and try again or use more than one cable for each line. A rule of thumb for the latter choice is: Every time you double the number of conductors (of equal gauge) the resulting apparent gauge is three less.

For example, you determine that you need #10 AWG wire but this is too large, so you decide instead to use two #13 AWG wires in place of each #10 wire and achieve the same effect. In this same example you could also substitute four #16 AWG wires.

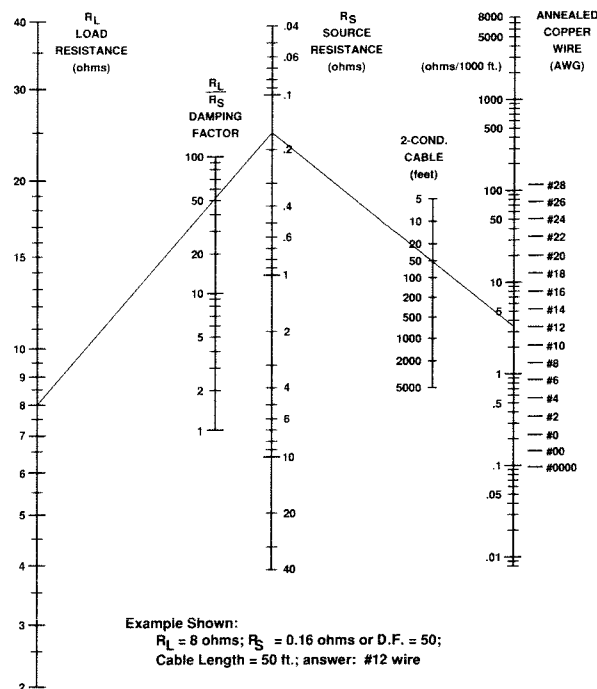

Fig. 3.5 Wire-Size Nomograph

To prevent high-frequency oscillations:

1. Lace the loudspeaker cables together.
2. Keep speaker cables well separated from input cables.
3. Never connect the amplifier's input and output grounds together.
4. Install a low-pass filter on the signal input line (see preceding Input section).

Use Good Connectors

1. To prevent short circuits, be sure male connectors on speaker cables are not exposed.
2. Do not use connectors which might accidentally cause the two channels to be tied together during connecting or disconnecting. (A common example is the standard 3-wire ¼-inch stereo phone plug.)
3. Do not use connectors which can be plugged into AC receptacles.
4. Do not use connectors having low current-carrying capacity.
5. Do not use connectors having any tendency to short, or having shorted leads.

3.3.4 Load Protection

Since PSA-2X amplifiers generate high power, you may desire to protect your loudspeakers (or other sensitive loads) from damage resulting from excessive power. A common way to do this is to put a fuse in series with the load. The fuse may be single, fusing the overall speaker system or it may be multiple, with one fuse on each driver.

Fuses help prevent damage due to prolonged overload, but provide essentially no protection against damage from large transients. To minimize this problem, use high-speed instrument fuses such as the Littlefuse 361000 series. Figure Fig. 3.7 is a nomograph showing fuse size versus loudspeaker peak power ratings.

If, on the other hand, the loudspeaker is only susceptible to damage caused by overheating, use a fuse or circuit breaker having the same slow thermal response as the loudspeaker itself (such as a slow-blow fuse).

3.3.5 Inductive Loads

Loads that are primarily inductive, such as 70-V step-up transformers and electrostatic loudspeakers, require special attention. To prevent large low-frequency currents from damaging them, it may be necessary to install a high-pass filter at the input.

We recommend a 3-pole (18 dB/octave) filter that rolls off at 80 Hz or higher. Such a filter, installed at the input, will protect the load and isolate the amplifier from the unwanted low-frequency problems discussed in Section 3.3.2.

3.3.6 Power

The PSA-2X comes with a three-wire 20 A, 120 VAC plug and a 15 A wall-socket adapter as standard equipment. A 20 A wall outlet should be used whenever possible.

Use the third-wire ground with caution since it may introduce a ground loop in a system (opening the ground shorting strap on the back panel will remove this loop). Power must be at 50-60 Hz. (Operation at 400 Hz is not possible unless a cooling fan motor rated at 400 Hz is utilized; NOT AVAILABLE from Crown.)

3.3.7 Converting Line Voltages

The amplifier power supplies offer multiple connections for operation at different line voltages. The serial plate indicates which voltage the amplifier was wired for at the factory.

Converting from one voltage to another is a fairly complex operation and should be attempted only by a competent technician. Voltage conversion instructions are given on the last page of this manual.

The high-voltage supplies use dual power transformers which must be wired identically. Failure to properly wire the primaries can result in transformer damage.

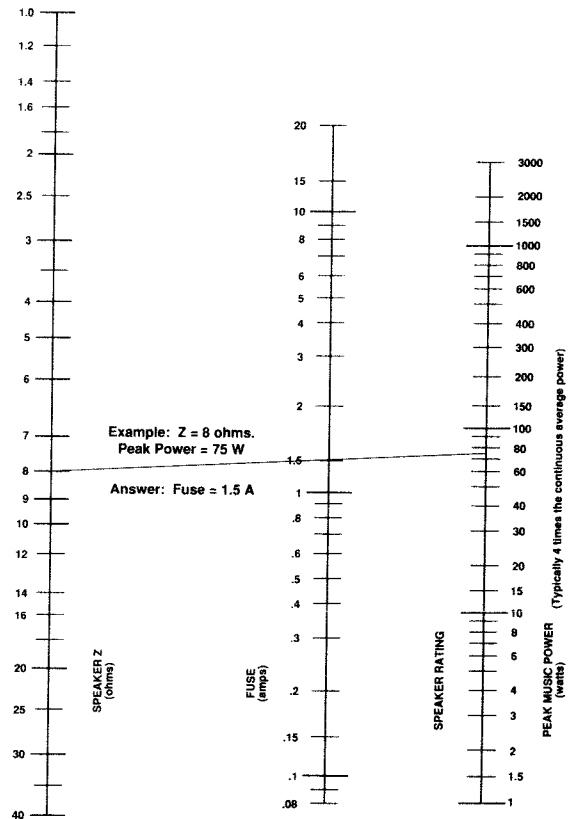

Fig. 3.6 Fuse Selector Nomograph for Loudspeaker Protection

Note: To change the voltage, first disconnect power and remove the bottom cover from the unit. (**Caution—the main supplies often remain charged for several minutes.**) The voltage connections are made with push-on connectors and terminal strips.

After the correct operating voltage has been chosen and all the primary leads identified, the conversion can be performed by following the connect drawing located on the interior of the bottom cover. Be sure to also make all necessary fuse changes (if needed).

When testing the amplifier, the line voltage must be the peak equivalent to a sinusoid of the indicated line voltage when at full load. Line regulation problems can introduce a substantial reduction in the available output power on an amplifier of this size.

Voltages above 150 V (100 V and 120 V connection) or 300 V (200 V and 240 V connection) are potentially damaging to the +15 V regulator, filter capacitors and output transistors and should be avoided.

4 Operation

4.1 Precautions

Although your amplifier is well protected from any external faults, we recommend the following precautions be taken for safe operation:

1. There are important differences between Stereo and Mono operating modes. Refer to section 3.3.1 for information on system hookup.
2. **WARNING: Do not change the position of the Stereo-Mono switch unless the amplifier is first turned off.**
3. Use care when making connections, selecting signal sources and controlling the output level. The load you save may be your own.
4. Do not short the ground lead of an output cable to the input signal ground. This may form a ground loop and cause oscillations.
5. Never parallel the output with any other amplifier's output. Such connection does not result in increased power output. Damage incurred by such operation is not covered under warranty.
6. Never drive a transformer-coupled device or any other device which appears as a low-frequency short (less than 3 ohms at DC) without a series isolating capacitor. Such operation may damage the device and/or needlessly waste output power.
7. Operate the amplifier from AC mains of not more than 10% variation above or below the selected line voltage and only the specified line frequency.
8. Never connect the output to a power supply output, battery or power main.
9. Turn the amp off and unplug it from the AC line before removing and cleaning the dust filter.
10. Tampering in the circuit by unqualified personnel or making unauthorized circuit changes invalidates the warranty.

Remember: Crown is not liable for any damage resulting from overdriving other components in your system.

4.2 Front Panel Displays

The front panel contains several helpful indicator LEDs (see Figure 2.1). An amber **Power On** LED, driven by the low-voltage power supply, will glow to indicate that power is on.

Two green **Signal** LEDs indicate signal presence of at least 1.2 volt peak at the output of that respective channel.

Red LEDs show **IOC** (Input/Output Comparator) status for each channel. When more than 0.05% distortion (of any type) occurs, they will illuminate. Since transient distortion

can occur very rapidly, a delay circuit ensures that these LEDs will remain on long enough to be easily noticed. **Note: occasional flashing after turn-off is normal.**

The yellow **Standby** lights illuminate at any time the amplifier is in the standby state. This will occur most often when using the DELAY feature immediately after turn-on.

4.3 Controls

Front Panel Controls:

Level controls for both channels are located on the left side of the front panel. Turn these full counterclockwise BEFORE turning on the power switch.

The **AC Power** switch, at the lower right-hand corner of the unit, is a simple 2-position on/off control. If the power switch is set at ON, the power indicator LED should be on unless power is not connected or an internal problem exists.

Rear panel controls:

The **Stereo-Mono** Switch sets the mode of operation.

The **Low Frequency Protection** switch, when turned on, causes the unit to go into standby mode if low frequency (DC-10 Hz) appears at the output. The unit will cycle back on from standby after the excessive low-frequency output subsides. Protects sensitive loads from low-frequency damage. **Note: When Low-Freq protect switch is engaged, always engage the Delay switch as well.**

The **Delay** switch causes a 4-5 second delay of main power supply turn-on. This protects the loads against turn-on transients.

4.4 Protection

The PSA-2X is protected against all common hazards that plague high-power amplifiers, including shorted, open or mismatched loads; overloaded power supplies; excessive temperature, chain-destruction phenomena, input-overload damage, and high-frequency blowups. The unit protects loudspeakers from DC in the input signal and from turn-on/turn-off transients. **It also detects and prevents unwanted DC on the outputs.**

The basic output-protection mechanism represents a dramatic departure from conventional designs. Computer analysis of transistor stress-test data, leading to design of appropriate dynamic transistor environment analog circuits, forms the heart of the system.

A continuous flow of operating data produces an analog output proportional to the changing Safe Operating Area (SOA) of the transistor. This output controls the limits imposed by a current gain stage ahead of the output section. The output limits this change along with actual operating conditions. The maximum advantage may then be taken of

the transistor's SOA, without risk of destroying the device when conditions are less than ideal.

Internal fuses, in combination with the power transformer's thermal switch embedded in the windings, protect the power supplies against overload. If the transformers overheat, the thermal switch shuts off automatically, waits until the unit has cooled to a safe temperature and then resets itself. In the rare event that an internal fuse blows, refer the amplifier to a qualified technician.

CAUTION: Never change fuses with power applied!

The high-voltage power supply is fused with a 20 A fuse for 100 V/120 V and a 10 A fuse for 200 V/220 V/240 V. The low-voltage power supply and cooling fan are fused with a 0.5 A fuse for 100 V/120 V and a 0.25 A fuse for 200 V/220 V/240 V. **The use of other fuse sizes will invalidate the warranty.**

4.5 Cleaning

A dust filter is provided on the air intake to the cooling system. If this filter becomes clogged, the unit will not cool as efficiently as it should and may produce lower-than-normal output levels due to high heat-sink temperature.

To clean, remove the filter by loosening the screws on the intake cover, turning the cover counterclockwise slightly so screws line up with larger part of opening, and pulling straight out. Use mild dishwashing detergent and warm water for best cleaning. Replacement filters may be ordered from the factory.

Dust filters are not 100% efficient. Long term use will require that the internal heatsinks be cleaned by a qualified technician. Internal cleaning information is available from our Technical Services Department.

5 Service

Your amplifier has very sophisticated circuitry which should only be serviced by a fully trained technician. This is one reason why each unit bears the following label:

CAUTION: TO PREVENT ELECTRIC SHOCK DO NOT OPEN. NO USER SERVICEABLE PARTS INSIDE. REFER SERVICING TO A QUALIFIED TECHNICIAN.

5.1 Amcron Service

Amcron customers may obtain service from an authorized Amcron Service Center. Your local Amcron representative or our office can supply a list of authorized service centers. Simply present the defective unit along with your bill of sale as proof of purchase to an Amcron Service Center. They will handle the necessary paperwork and repair.

Remember to transport your unit in the original factory pack. Amcron will pay the surface shipping costs both ways **for warranty service** to the authorized service center nearest you after receiving copies of all shipping receipts. You must bear the expense of all taxes, duties, and customs fees when transporting the unit.

5.2 Crown Service

Crown customers may obtain service either from an authorized Crown Service Center or from the Crown factory in Elkhart, Indiana. It is important that you have your copy of the bill of sale as your proof of purchase.

5.2.1 Service at a Crown Service Center

This method usually saves you the most time and effort. Simply present your bill of sale along with the defective unit

to an authorized Crown Service Center. They will handle the necessary paperwork and repair. Remember to transport your unit in the original factory pack.

5.2.1 Crown Factory Service

To obtain factory service, fill out the Service Information card in the back of this manual and send it along with proof of purchase and the defective unit to the Crown factory. Enclose a letter explaining the nature of the problem and what service you would like. Include your return shipping address and telephone number.

The unit must be shipped in the original factory pack. If you no longer have the original shipping pack, contact us and we will send you a replacement.

Crown will pay surface shipping costs both ways in the United States for warranty service upon receiving copies of all shipping receipts. Shipments should be sent UPS Ground. The factory will return your serviced unit via UPS Ground. Please contact us if other arrangements are necessary.

**Crown/Amcron
Technical Services Department
57620 C.R. 105
Elkhart, Indiana 46517**

**Phone: 1-800/342-6939 or: 1-219/294-8200
Crown Fax: 1-219/294-8329
Amcron Fax: 1-219/294-8346**

6 Technical Information

6.1 Overview

The PSA-2X is a high-power direct-coupled amplifier. It automatically and continuously analyzes its own dynamic environment and thus is able to control the output level relative to the output transistors' Safe Operating Area. The result: maximum output with maximum safety.

The output circuitry employs 16 rugged 150-watt transistors (2400 W dissipation), each tested on the Crown SOA III Transistor Analyzer. This testing verifies the safe operating area of each output device, which in turn helps improve the amplifier's overall circuit performance.

The output transistors operate in the AB mode of operation where quiescent current is carried by both the driver stages and the output stages. The output is a quasi-complementary design in which the common point between positive and negative output stages is returned to ground. Therefore, the power supplies are allowed to float with the signal output terminal common to the center tap of the high voltage power transformer.

The high-voltage power supply contains two transformers (one per channel) for driving the output stages. Because of this independence, a single channel output stage problem (very unlikely) will not affect the performance of the other. The single low-voltage power supply is responsible for pre-output signals and low power components (LEDs, fan, etc.).

All heat-sinking is internal, eliminating handling problems when the unit is hot as well as providing a shorter and more efficient path for air flow than standard convection cooling.

6.2 Circuit Theory

Refer to the block diagram, Fig 6.1. The diagram does not show all circuit connections or feedback loops due to circuit complexity, but there is sufficient data to grasp the function of each circuit. Note that only channel 1 is shown for simplicity.

An input signal is fed to the initial stages via the standard unbalanced input or the optional balanced input. Both cannot be used simultaneously due to the "interrupt" function of the unbalanced input jacks.

(The balanced input jacks are located on a separate rear-panel plug-in module. See Section 8 for information on the Balanced Input Mod.)

The input amplifier receives the signal next and sends any necessary error-correcting into the Compressor Control circuitry as well as sending the main signal on to the

Balanced Stage. Essentially, this feedback path (from the output of the input amp through the Compressor Control circuitry) adjusts the amount of compression needed at that particular instant to provide distortion-free output.

In order to drive the Positive and Negative Output Stages, a Balanced Stage is necessary. Should a situation be encountered where protection of the Output Stages is needed, the Protection Circuitry will automatically reduce the drive available to the Balanced Stage and thus remove the stress on the output devices.

Both the Positive and Negative Output Stages consist of four SOA-analyzed and V_{BE}-matched output transistors plus a predriver/driver combination that also aid in carrying the quiescent power load. Together they help form the quasicomplementary Class AB method of operation used in the PSA-2X.

Feeding positive current to the POSITIVE OUTPUT STAGE, and negative current to the NEGATIVE OUTPUT STAGE, are the POS and NEG V_{cc} (High Voltage) Supplies. The common point between the two Output Stages is ground. A departure from previous smaller Crown amps, this method allows sophisticated information to be fed to the protection Circuitry from the Output Stages with reference to ground. Both channels' High Voltage supplies work independently of one another.

The point Common to the Neg and Pos V_{cc} supplies is the "hot" signal of the output terminal which also feed the front panel Display, the Mono switch (for selectable stereo-mono output) and several of the main feedback paths.

The Control Logic is responsible for the action of the Lo Freq Protect, Delay, Standby and thermal protection of the unit. When signaled by the Lo Freq Protect, Standby and/or Delay feature, the Control Logic will remove the power from the V_{cc} supplies. In the case of Low Freq Protect, when the output has subsided it will place the high-voltage supplies back into operation from Standby or cycle through the same procedure again depending upon the existence of the problem.

Thermal protection may involve the same procedure as mentioned above but only in extreme cases. A thermal switch imbedded in the high-voltage transformer's windings will activate the Control Logic when potentially damaging current demands are being placed on it.

The Low Voltage supply drives all low-power signal path circuitry including the Control Logic, Display and Fan speed logic. At an internal temperature of 47° C (117° F), the unit will automatically shift to high fan-speed operation for additional cooling.

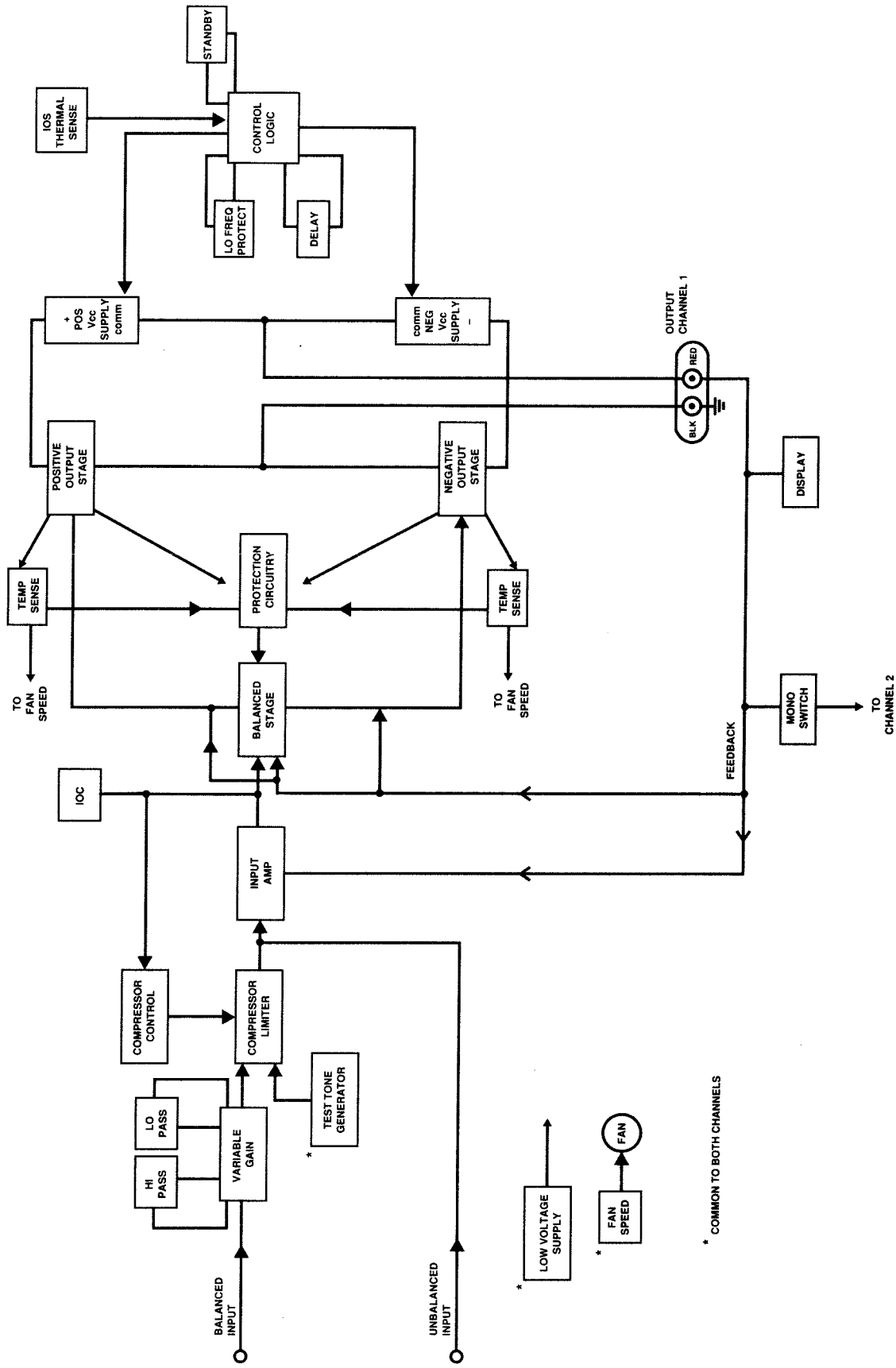

Fig. 6.1 Circuit Block Diagram

7 Specifications

7.1 Performance

Note: 8 ohm loads were used unless specified otherwise.

Frequency Response

Stereo: ± 0.1 dB from 20 Hz to 20 kHz at 1 watt. +0, –1.5 dB from DC (0 Hz) to 80 kHz. See Figure 7.2.

Bridged Mono: ± 0.2 dB from 20 Hz to 20 kHz at 1 watt into 16 ohms.

Phase Response: +0, –15 degrees from DC (0 Hz) to 20 kHz at 1 watt. See Figure 7.3.

Hum and Noise: 115 dB below rated output (A-weighted). 110 dB below rated output (20 Hz to 20 kHz).

Total Harmonic Distortion (THD)

Stereo: Less than 0.002% from 20 Hz to 1 kHz and increasing linearly to 0.05% at 20 kHz at 220W/channel.

Bridged Mono: Less than 0.003% from 20 Hz – 1 kHz and increasing linearly to 0.08% at 20 kHz at 500 W into 16 ohms. Less than 0.005% from 20 Hz – 1 kHz and increasing linearly to 0.12% at 20 kHz at 800W into 8 Ω .

IM Distortion (IMD)

Stereo: Less than 0.01% from 0.25 watts to 220 watts per channel. See Figure 7.5.

Bridged Mono: Less than 0.015% from 0.25 watts to 500 watts into 16 ohms. Less than 0.015% from 0.25 watts to 700 watts into 8 ohms.

Crosstalk: See Figure 7.4.

Slew Rate

Stereo: Greater than 30 volts per microsecond.

Bridged Mono: Greater than 60 volts per microsecond.

Damping Factor: Greater than 700 from DC to 400 Hz. See Fig. 7.7.

7.2 Power

Output Power

Note: Maximum average power at 1 kHz with no more than 0.1% THD. (See power matrix for further details.)

Stereo: 700 W per channel into 2 Ω . 460 W per channel into 4 Ω . 275 W per channel into 8 Ω . See Fig. 7.8.

Bridged Mono: 915 W into 8 ohms.

Load Impedance: Rated only for 16 to 2 ohm usage (Stereo) and 16 to 8 ohm usage (Bridged Mono). Safe with all types of loads (even totally reactive ones).

Required AC Mains: 50-400 Hz AC with selectable transformer taps for 100, 120, 200, 220 and 240 V ($\pm 10\%$) operation.

It is extremely important to have adequate AC power available to the amplifier. Power amplifiers can not create energy—they must have the required **voltage and current** to deliver the undistorted rated wattages you expect.

AC Line Connector: Standard three-wire grounded connector.

High Voltage Supply: Two 800 VA transformers with computer grade capacitors powered through 10 A relays.

Low Voltage Supply: ± 15 VDC supplies are provided by a current-limited short-proof regulator.

7.3 Controls

Power: A two-position switch, located on front panel, turns the unit on and off.

Level: A level control for each channel is located on the front panel.

Stereo-Mono: A two-position switch, located on the back panel, selects between Stereo and Bridged-Mono modes of operation.

Low Freq Protect: A two-position switch, located on the back panel, activates the subsonic protection circuitry.

Delay: A two-position switch, located on the back panel, activates a 4-second turn-on delay to protect loudspeakers from unwanted turn-on transients.

7.4 Indicators

On: An amber indicator which shows the unit has been turned on.

Standby: Normally off, these yellow indicators turn on if a channel is placed in STANDBY mode.

Signal: These green indicators flash synchronously with the input signal to show its presence.

IOC: Normally off, these red indicators flash in the rare event the output waveform differs from that of the input by 0.05% or more.

7.5 Input/Output

Input Connector: Unbalanced 1/4-inch phone jack for each channel.

Input Impedance: Nominally 25 K ohms ($\pm 30\%$).

Input Sensitivity

Stereo: 2.1 volts for 220 watts into 8 ohms per channel.

Bridged Mono: 2.2 volts for 500 watts into 16 ohms.

Output Connector: Color-coded dual binding posts (banana jacks) on standard 3/4 inch centers, spaced 3/4 inch apart.

Output Impedance

Stereo: Less than 12 milliohms in series with less than 1.2 microhenries. See Figure 7.9.

Bridged Mono: Less than 24 milliohms in series with less than 2.4 microhenries.

Output Signal

Stereo: Unbalanced, two-channel.

Bridged Mono: Balanced, single-channel. The controls of Channel 1 are active and the controls of Channel 2 are inactive but not removed from operation. This means the Channel 2 controls should NOT be used but should be turned down for proper mono operation.

DC Output Offset: 0.0 ± 10 millivolts with shorted input.

Voltage Gain

Stereo: 20:1 $\pm 2\%$ or 26 dB ± 2 dB at maximum gain.

Bridged Mono: 40:1 $\pm 2\%$ or 32 dB ± 2 dB at maximum gain.

Chassis Ground: Two-terminal barrier block with shorting strap.

Accessory: An internal plug, accessed through the rear panel cover plate, accepts optional balanced-input module.

7.6 Protection

Protection circuitry limits the output level to protect the output transistor stage, even in the case of elevated temperature. Transformer overheating results in shutdown

(STANDBY) of that particular channel. Controlled slewing rate voltage amplifiers protect the unit against RF (radio frequency) burnouts. Input overload protection is furnished by a resistor at the input of the amplifier to limit current.

Turn On: Can be selected for either instantaneous or four-second delay after applying power. The unit, itself, creates no dangerous transients.

Low Frequency Load Protection: A switchable protection circuit is provided to place the unit in STANDBY mode when subsonic output (from DC to 10 Hz) is greater than 26 V. See Figure 7.10.

7.7 Construction

All aluminum construction for maximum heat conduction and minimum weight with specially-designed "flow-through" ventilation top, front and side panels. Satinized aluminum front panel with grey suede Lexan insert and black painted aluminum chassis covers.

Cooling: Forced-air with high-efficiency coolers. A two-speed fan with an intake filter (washable) mounted on the back panel forces air through the coolers and out both the top and side panels.

Dimensions: 19 inch (48.3 cm) standard rack mount width (EIA Std. RS-310-B), 7 inch (17.8 cm) tall, 14.75 inch (37.5 cm) deep behind front mounting surface.

Weight: 57 pounds (25.9 kg).

Mounting: Standard EIA 310 front-panel rack mounting.

Crown specifications are guaranteed for three years.

At Crown our published specifications are *guaranteed* for three years. Further, because our “in-house” specs are more stringent than our published specs, *every* Crown amplifier will *exceed* its published specs.

Other manufacturers may publish specifications with a tolerance of ±1 dB or worse. This means their amplifier can deviate more than 20% in output! For example, a 100 watt amp would meet their spec if it only produced 79.4 watts. Still other manufacturers qualify their specs by saying they are “typical” or “subject to manufacturing tolerances,” thereby removing any performance guarantee.

Why a Power Matrix?

The maximum output power an amplifier can produce varies with both the type of load and the type of input signal. This is why we provide the following power matrix—to provide power data for a variety of conditions. The power matrix also gives you enough data to accurately compare the high power producing capabilities of our amplifiers with the amps of other manufacturers. Without this data you might be comparing “apples to oranges.” Some spaces in the table may be left blank because we do not provide a guaranteed spec for that situation—however, your amplifier will perform well under all conditions whether shown in the matrix or not.

We believe you should get what you pay for.

P S A - 2X							
Configuration & Load (ohms)	FTC Continuous Average Power at 0.1% THD (See note 1)		Max Average Power at 0.1% THD (See note 2)	1 Cycle Tone Burst Watts at <0.05% THD (See note 3)	40 mS Tone Burst Watts at <0.05% THD (See note 4)	EIA Watts at 1% THD (See note 5)	
	20Hz-20kHz	1 kHz	1 kHz	1 kHz	1 kHz	1 kHz	
Stereo (both channels powered)	2		580	700	840	740	650
	4	380	425	460	640	470	470
	8	265	260	275	335	280	285
	16	150	150	150	170	155	160
Bridge-Mono (balanced output)	4		1,210				
	8	760	850	915	1,260	950	920
	16	520	520	545	670	565	565

Fig. 7.1 Power Matrix

Notes:

All of the above specifications were performed with 0.1% regulated AC mains of 120 VAC, 60 Hz and an ambient room temperature of 70° F (21° C).

1. Continuous power in the context of Federal Trade Commission testing is understood to be a minimum of five minutes of operation. Harmonic distortion is measured at the RMS sum total as a percentage of the fundamental output voltage. This applies for all wattages greater than 0.25 watts.
2. A 1 kHz sine wave is presented to the amplifier and the output monitored for non-linear distortion. The level is increased until the THD reaches 0.1%. At this level the average power per channel is reported.
3. A single cycle of sine wave is fed to the amplifier and monitored for non-linear distortion. The average power during the burst is reported. Speakers must be able to withstand this level to be safely used with this amplifier.
4. A 40 millisecond burst or two cycles of sine wave (whichever is of greater duration) is used and the power computed as the average power during the burst. The duty cycle of this test is 10 percent. This power level is a measure of how loud an amplifier is as perceived by the hearing process.
5. EIA standard RS-490 (both channels driven).

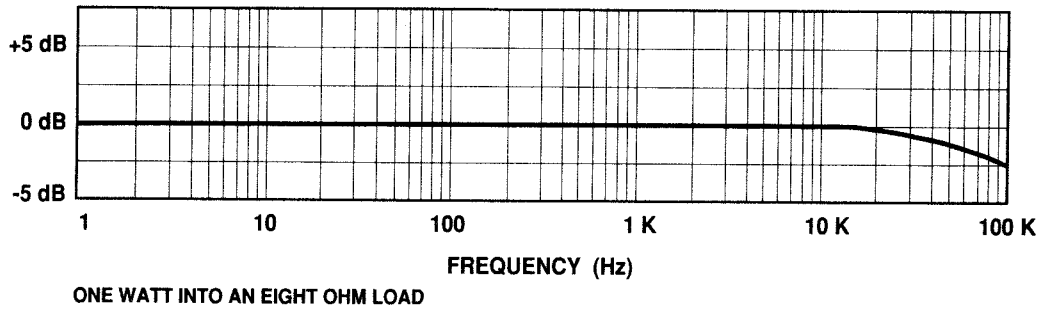

Fig. 7.2 Typical Frequency Response

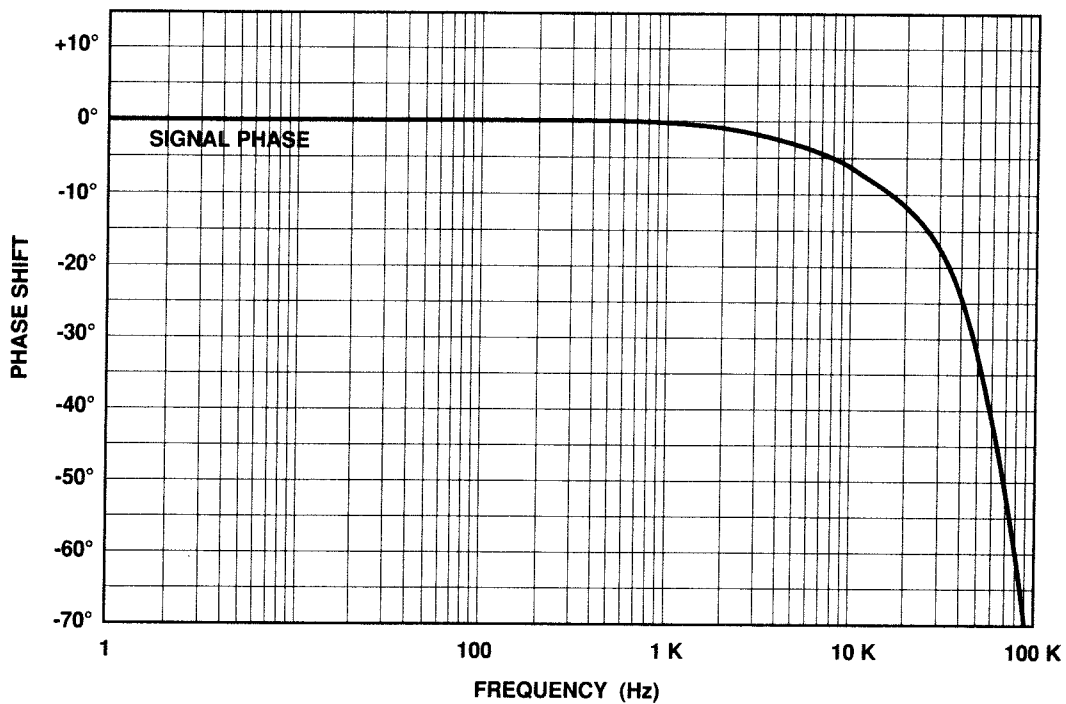

Fig. 7.3 Typical Output Phase Response

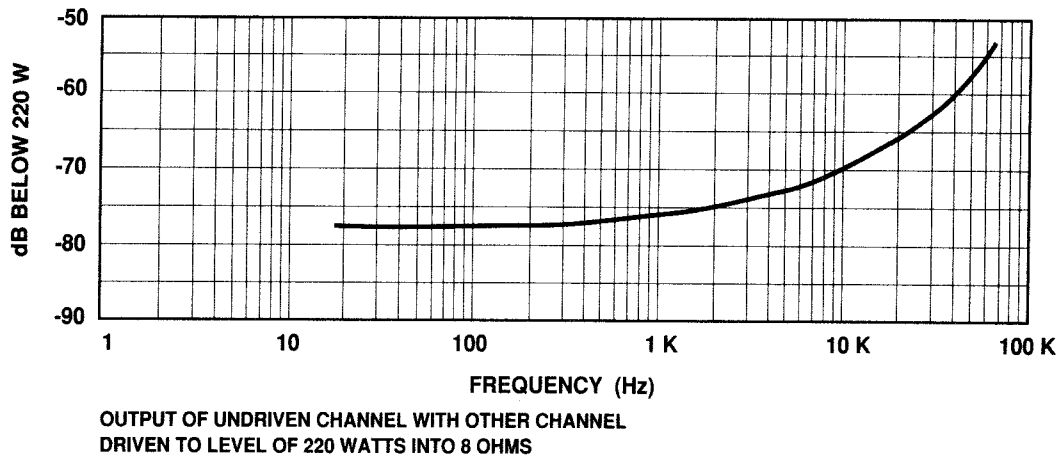

Fig. 7.4 Typical Crosstalk

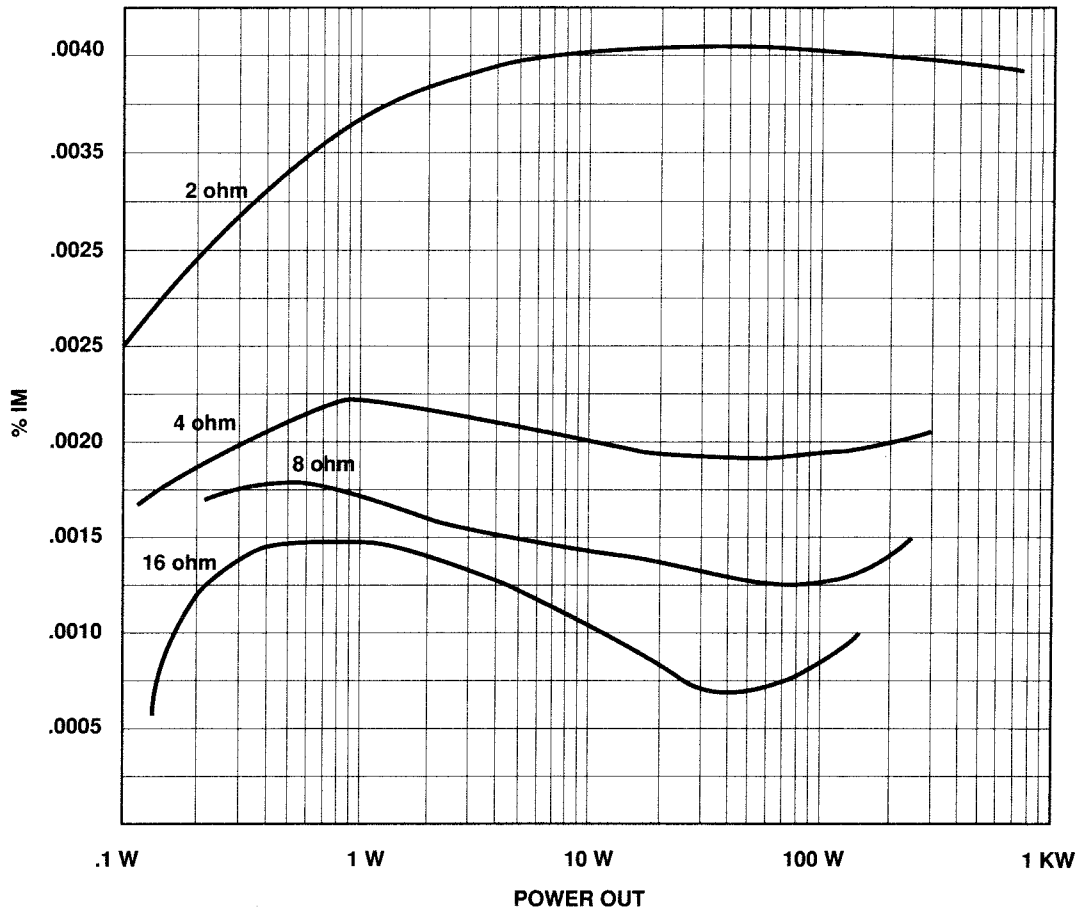

Fig. 7.5 Typical IM Distortion

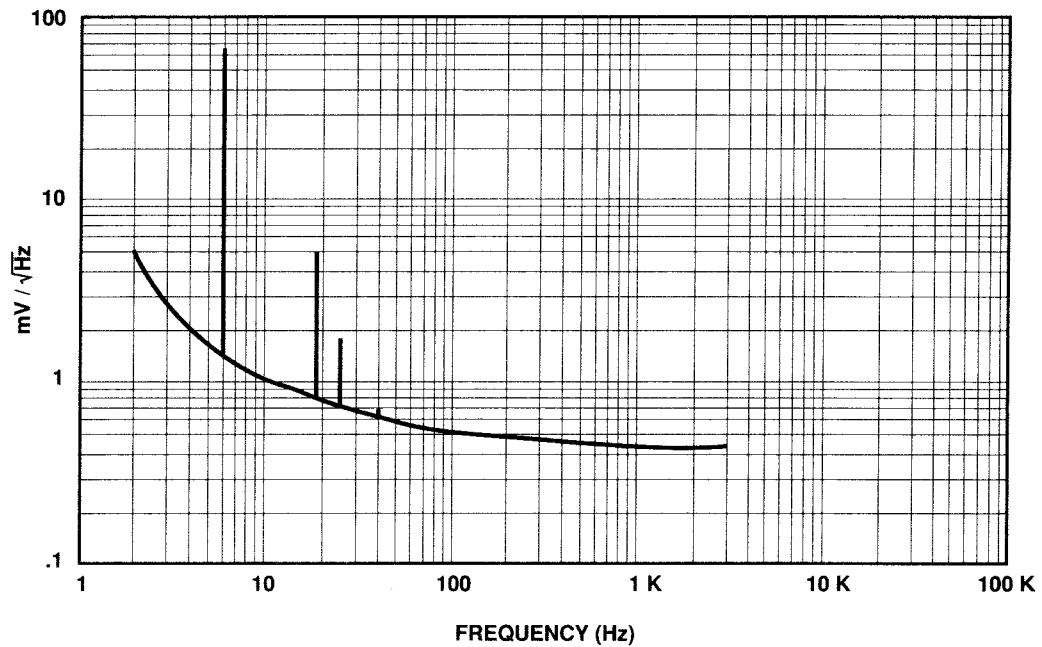

Fig. 7.6 Typical Noise Spectrum

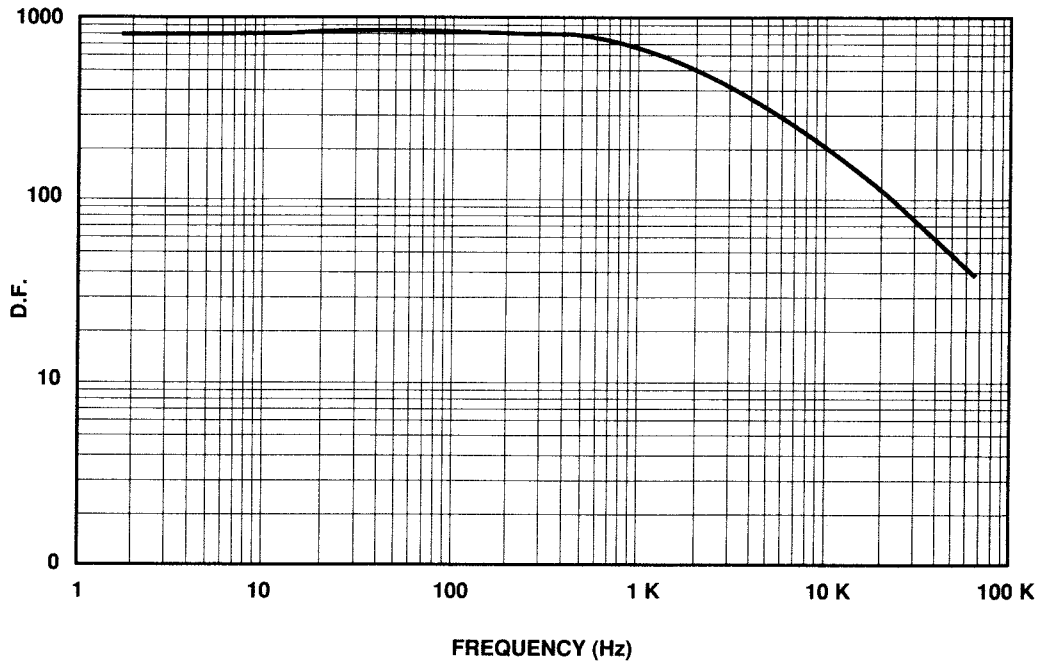

Fig. 7.7 Typical Damping Factor (8 ohm)

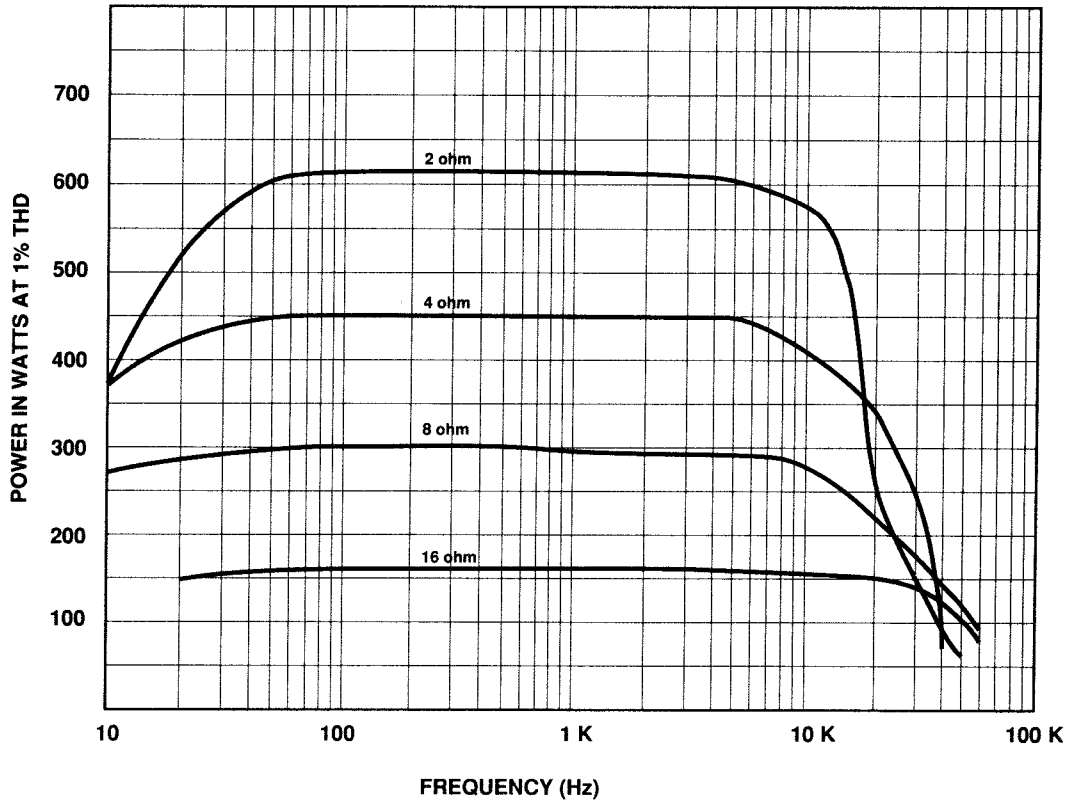

Fig. 7.8 Typical Power Output, 16, 8, 4 and 2 ohm

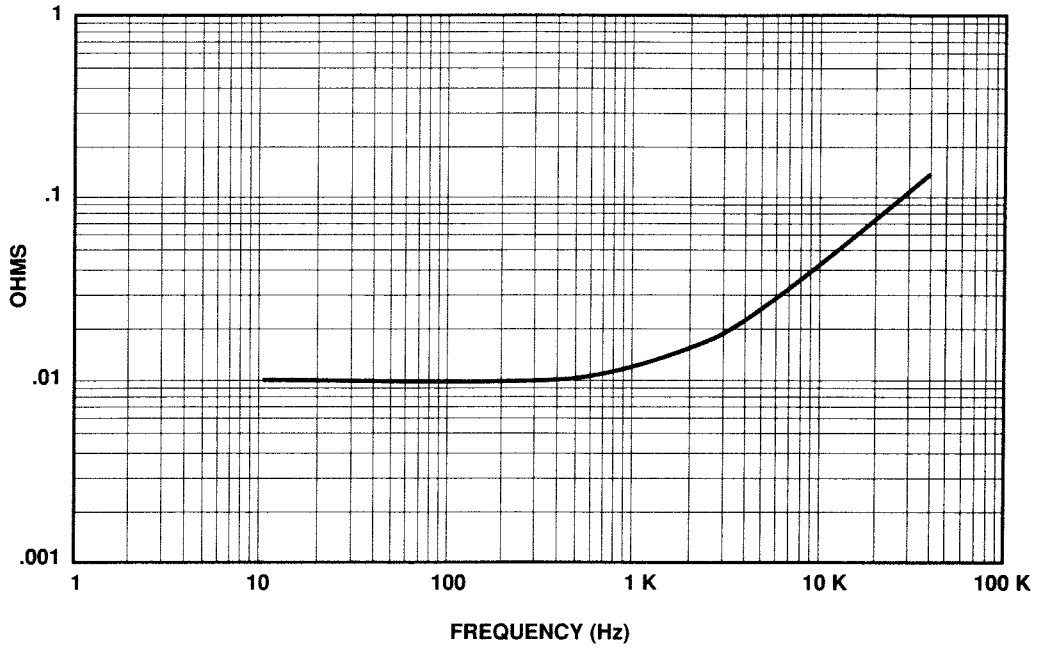

Fig. 7.9 Typical Output Impedance

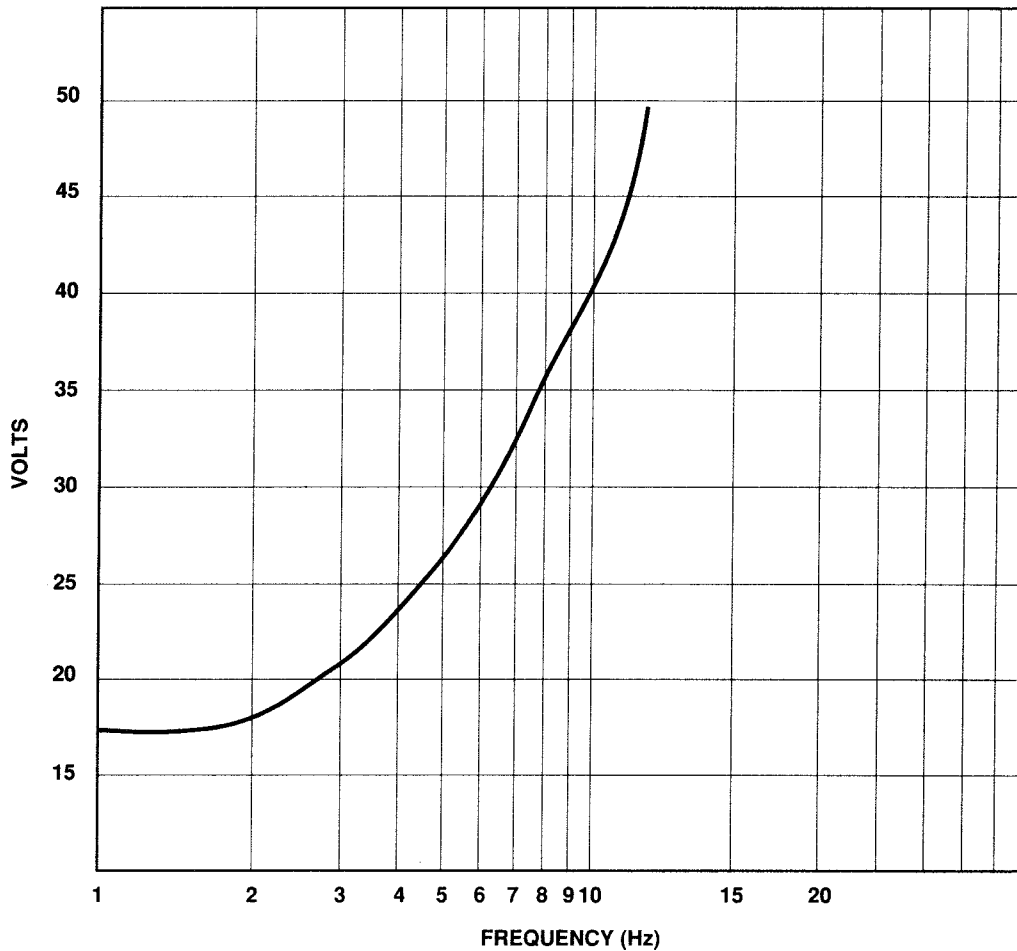

Fig. 7.10 Typical Low-Frequency Protect Action

8 Balanced Input module

8.1 Features

The PSA-2 Balanced Input Mod (PSA-2 Mod) is an accessory card that plugs into the rear of the PSA-2X. It contains several professional features:

- XLR-type balanced input connectors
- Gain adjustment controls
- Test-tone generator
- High-pass and low-pass filters
- Automatic gain control (AGC)

XLR-type balanced input connectors: One per channel, these greatly reduce hum and noise picked up by the input lines. Pin 1 is ground, pin 2 is audio in-phase, and pin 3 is audio return. Connecting to the unbalanced phone-jack inputs disables the XLR input connectors.

Gain adjustment controls: These potentiometers control the amplifier's internal gain (from 0-10 dB). In most cases, the input sensitivity of the PSA-2 is sufficient to achieve full output from most mixers, etc. However, if additional gain is necessary, simply increase the control, being careful not to overload the input stages of the amplifier. The unit is factory shipped with input gain adjustment at unity gain.

Test tone: This is a wideband pulse that covers 50 Hz to 20 kHz—extremely useful for system troubleshooting. The tone signal appears at the speaker dual-banana output jacks. Because the tone is a wide-band signal, it is possible to hear the tone throughout the woofer midrange and tweeter range.

To activate the tone, follow this procedure:

1. **Caution:** Turn input level controls completely CCW before activating the test tone generator.
2. Activate the test-tone slide switch between the XLR input jacks.
3. Use the front panel level controls to bring the level up slowly!!

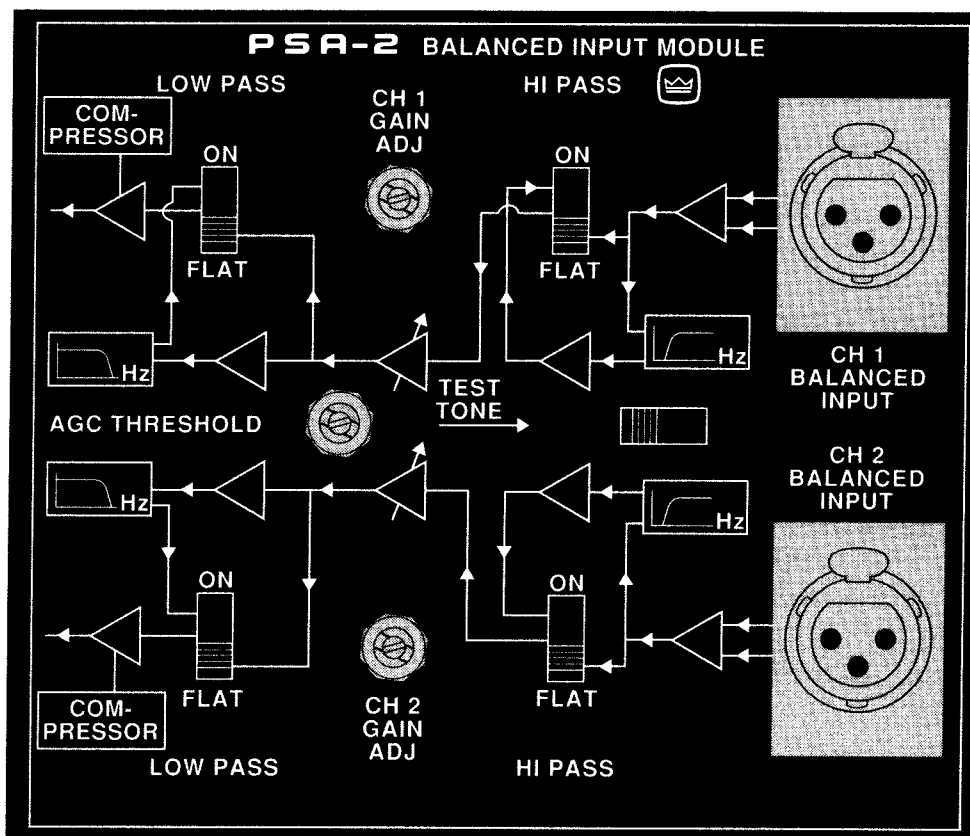

Fig. 8.1 PSA-2 Balanced Input Module

High-pass and low-pass filters: Each channel of the balanced input module incorporates a low-pass and high-pass filter slide switch. By engaging either switch, you activate that channel's filter at the factory-set frequency of 50 Hz for the high-pass filter and 15 kHz for the low-pass filter. These filters help prevent load damage at subsonic and ultra-high signal frequencies. They are switchable, 3-pole Butterworth filters.

Should the rolloff frequency need changing, you must change several components located on the input module.

Figure 8.2 lists the component changes and formulas needed for any desired cutoff frequencies.

Component changes for various high-pass and low-pass cutoff frequencies

1. C103, 203, 104, 204, 105, and 205 all equal C*
2. R107, 207, 108, 208, 109, and 209 all equal R*
3. R* and C* are chosen according to the following general limitations:
 - a) $1K < R^* < 330K$ (increasing R* value gives increased noise)
 - b) R102, 202 > 2K
 - c) R104, 204 < 1M
4. With valid values of R* and C*, the other resistor and capacitor values are chosen according to the following formulas:

$$R_{102,202} = \frac{.7184}{2\pi f_h C^*}$$

$$R_{103,203} = \frac{.2820}{2\pi f_h C^*}$$

$$R_{104,204} = \frac{4.941}{2\pi f_h C^*}$$

$$C_{107,207} = \frac{1.392}{2\pi f_l R^*}$$

$$C_{108,208} = \frac{3.546}{2\pi f_l R^*}$$

$$C_{109,209} = \frac{.2024}{2\pi f_l R^*}$$

When f_h = high-pass cutoff
When f_l = low-pass cutoff

5. For values shown in schematic $f_h = 50$ Hz and $f_l = 15$ kHz

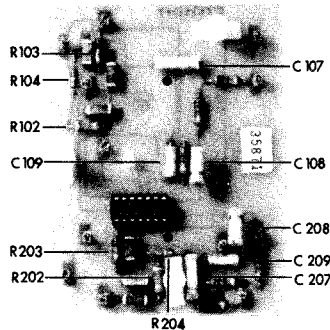

Fig. 8.2 Low-/High-Pass Conversion Formulas

Automatic Gain Control (AGC) Threshold Adjust: The Automatic Gain Control circuit is a limiter-compressor circuit designed for use with sound-reinforcement systems. It effectively controls excessive signals with a minimum of waveform distortion. The AGC Threshold Adjust controls the point at which the AGC circuit begins to limit the output.

The unit is shipped from the factory with the control fully clockwise. This means a higher output level is attainable before any limiting action takes place as compared to a lower output level with the control decreased (turned CCW). See the graphs in Fig. 8.3 for various control positions and functions.

As shown on these graphs, no matter where the Threshold Control is adjusted, a constant 13 dB of compression is available after that point. With an increased input level under 13 dB, the output signal will not rise. Over 13 dB, the signal will continue to rise as if the limiter/compressor circuitry was not utilized.

Note that the shaded areas indicate the "clip area" of operation. This is the reason the front panel *IOC* indicators begin and continue to illuminate throughout this region. Therefore, you can operate the amplifier with the *IOC* indicators illuminated (graph A), but with relatively little distortion produced at the output of the amplifier because of the constant limit on the signal.

There are basically two methods which may be used to properly adjust the AGC Threshold Control: the listening method or the measurement method.

Listening Method

This method required the use of two important tools: your right and left ears (one may be used in case of emergency).

1. Connect the PSA-2 as shown in Fig. 3.1.
2. Loosen the locking level nut from the AGC Threshold Control and adjust full counter-clockwise (minimum).
3. Increase the listening level (either by the input source or by the front panel input level controls) until the output remains at a constant level. This level is the 13 dB of limiting shown in the previous graphs.
4. Continue increasing the input source until the output level rises abruptly (limiting no longer effective).
5. Increase the AGC Threshold Control to maximum desired listening level ("x" dB).
6. The input may now be increased by the same amount ("x" dB) without increasing the output level into severe clipping.

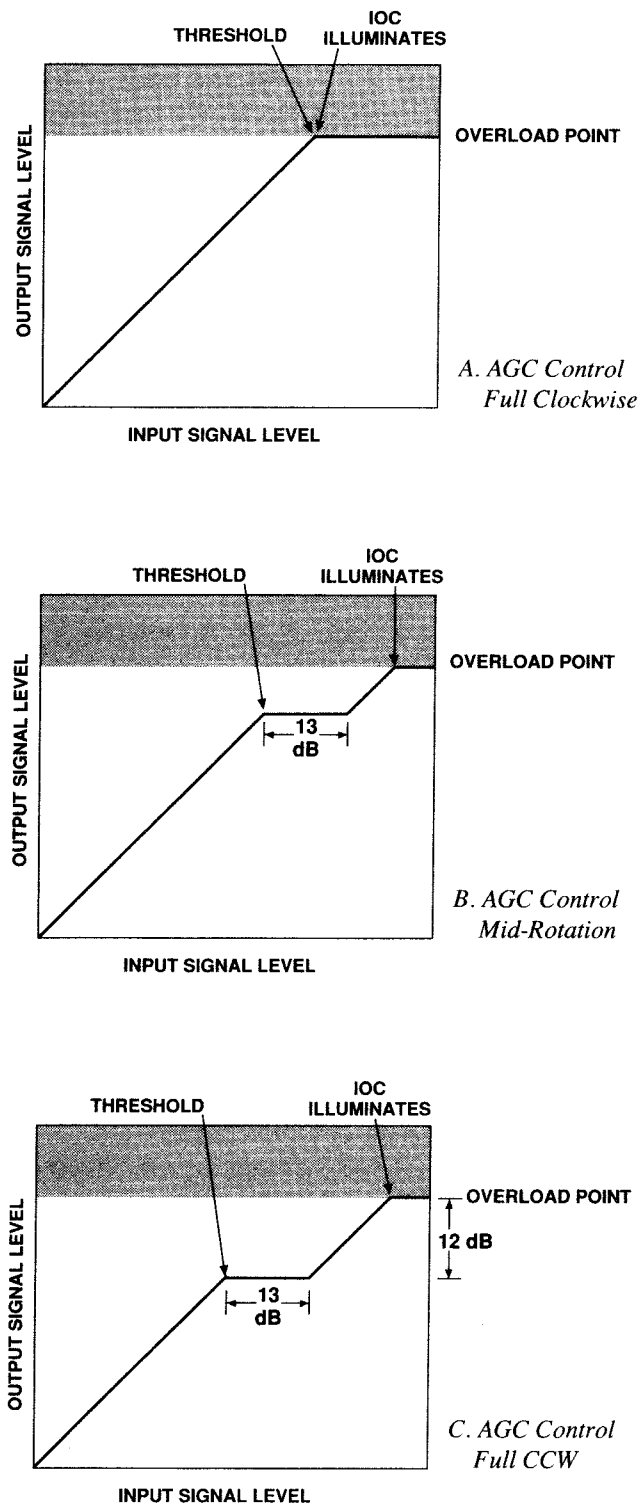

Fig. 8.3 AGC Threshold Control Positions

Measurement Method

1. Connect the PSA-2 as shown in Fig. 3.1 except replace the load with a RMS voltmeter.
2. Determine the amount of voltage necessary to produce the desired wattage level with a specific speaker. For example:

Speaker rating: 8 ohm

Desired wattage: 30 watts continuous

Desired voltage: calculated by $E^2=PR$

$$E^2=30 \times 8$$

$$E^2=240$$

$$E=15.5 \text{ V RMS}$$

3. Loosen the locking level nut from the AGC Threshold Control, and adjust to full counter-clockwise (minimum).
4. Increase the input level until the output remains at a constant voltage (use an input signal representative of the application).
5. Continue increasing the input signal until the output voltage rises abruptly (limiting no longer effective).
6. Increase the AGC Threshold Control to the desired RMS voltage.
7. Input may now be increased without altering the output level voltage (for the 13 dB range).

The AGC circuitry is limited to 13 dB in order to eliminate severe feedback problems that could exist during pauses of program material.

If you don't want the AGC feature, you can deactivate it by removing several components. Refer to the Balanced Input Module Schematic MI-277;

1. To deactivate both channels, remove LM339 Comparator, U6.
2. To deactivate only channel 1, remove U4 (do not remove U6).
3. To deactivate only channel 2, remove U5 (do not remove U6).

8.2 Circuit Theory

An input signal is fed to the initial stages via the standard unbalanced input or the balanced input. Both cannot be used simultaneously due to the "interrupt" function of the unbalanced input jacks.

The balanced input jacks are located on a separate, rear-panel plug-in module (PSA-2 Mod) which also contains several other professional features.

A Variable Gain stage, next in line on the Balanced Input Module, adds an adjustable voltage gain (0-10) ahead of the main amplifier.

Connected to this stage are high- and low-pass filters, factory set at 50 Hz and 15 kHz respectively.

The resultant of the above-mentioned stage, along with a switch-controlled wide-bandwidth Test Tone Generator signal, is fed to the Compressor-Limiter circuitry. At its output point, an unbalanced signal may enter if so desired via 1/4" phone jacks.

The input amplifier receives the signal next and sends any necessary error-correcting info to the Compressor Control circuitry as well as sending the main signal on to the Balanced Stage. Essentially, this feedback path (from the output of the input amp through the Compressor Control circuitry) adjusts the amount of compression needed at that particular instant to provide distortion-free output.

8.3 Specifications

Controls: Channel 1 and Channel 2 input gain adjust, also the AGC Threshold adjust.

Hum and Noise: -85 dBm equivalent input noise, 20 Hz-20 kHz, 600-ohm source, gain set at unity.

Frequency Response: Flat ± 0.2 dB, 20 Hz to 20 kHz. See Figure 8.4.

High Pass and Low Pass Filters: 3-pole Butterworth 18 dB per octave; 50 Hz and 15 kHz standard frequencies. (Other roll-off points available; see Fig. 8.2 for details.) Slide switch activated.

Compressor Action: Range of compression restricted to 13 dB by design (wider range would aggravate feedback in live performance). Threshold adjustable from overload level of main amplifier to 12 dB lower. See Figure 8.6.

Balanced Input Voltage Gain: Variable 0-10.

Test Tone: Switch-activated wideband pulse, 50 Hz-20 kHz.

Common-Mode Rejection: 70 dB from 5 Hz-20 kHz; 55 dB at 20 kHz. See Figure 8.5.

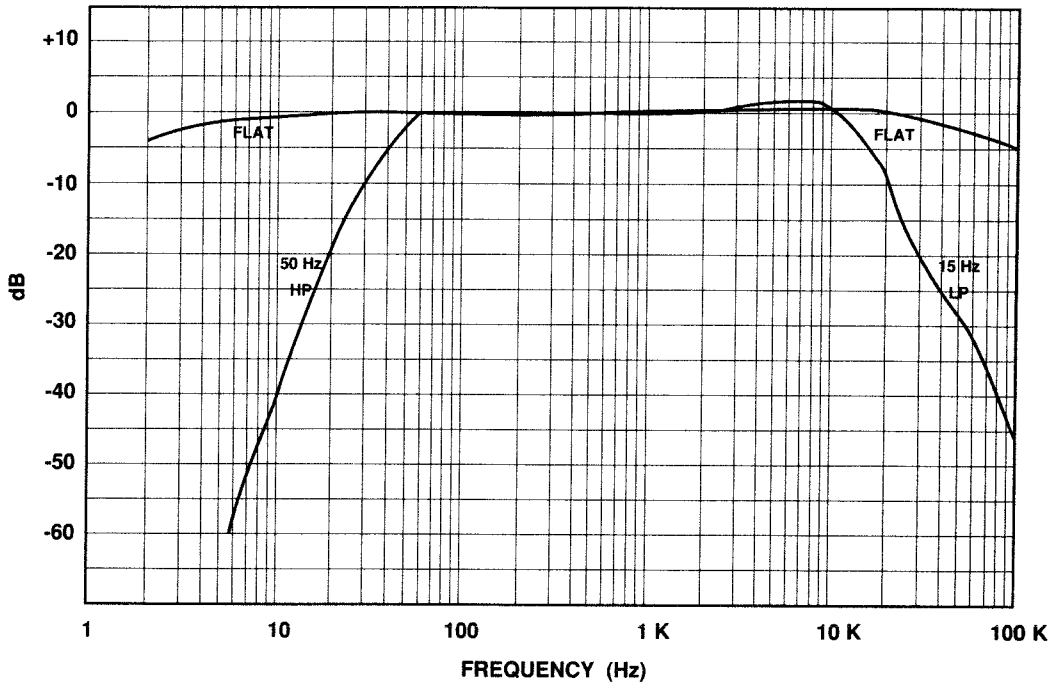

Fig. 8.4 Typical Frequency Response—Balanced Input Module

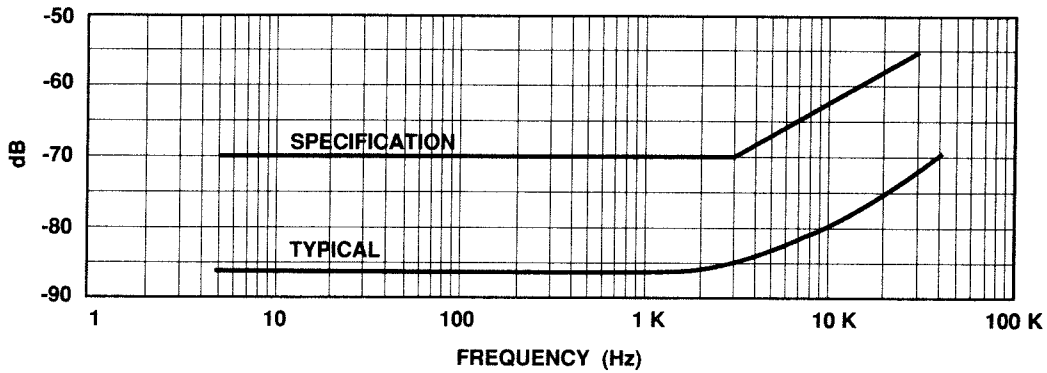

Fig. 8.5 Typical CMR Through Balanced Input Module

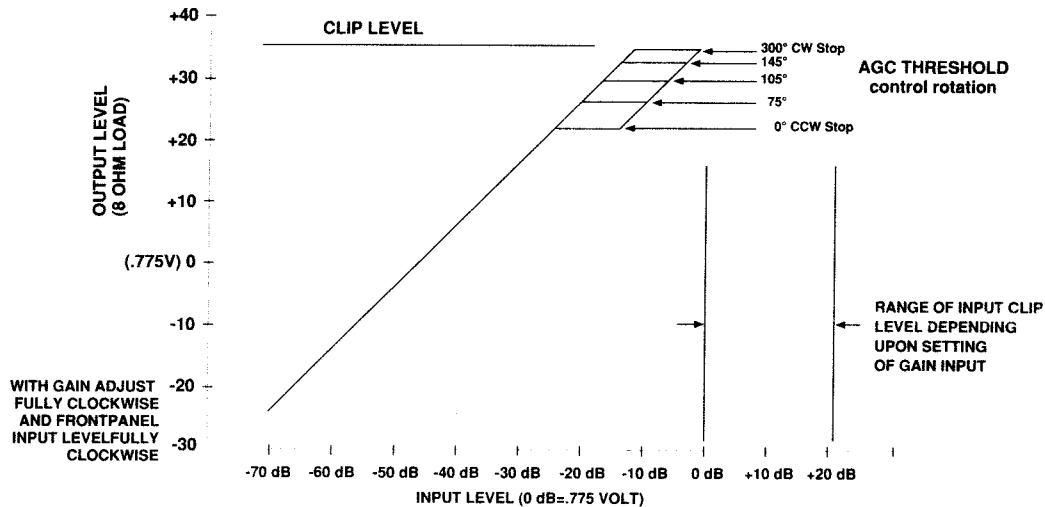
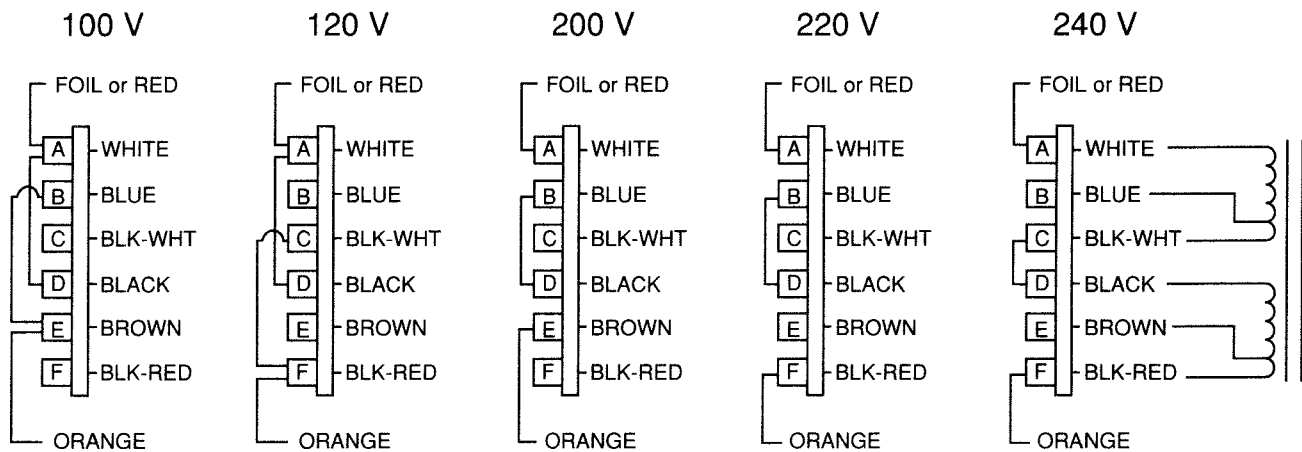

Fig. 8.6 Typical AGC Action

Voltage Conversion Instructions

1. Disconnect power and remove bottom cover.
2. Select the desired operating voltage.
3. Identify all leads and follow the connect drawing shown below.
All connectors are made with push-on terminals.
4. Make all necessary fuse changes (if needed).

VOLTAGE CHANGE JUMPERS



NOTE:

Three sets of jumpers must be changed. One set on each large power transformer and one set on the relay board. When selecting 100 or 120 volts, F1 and F2 (refer to schematic diagram) should be 20 amps and F3 1/2 amp. For 200, 220 and 240 volts, both F1 and F2 should be 10 amps and F3 should be 1/4 amp.

