

AETECHRON



CIS-25

Conducted/Induced Susceptibility EMC Testing Kit

Operation Manual

574.295.9495 | www.aetechron.com
2507 Warren Street, Elkhart, IN 46516



CIS-25 System

1 About the CIS-25 Test System



Congratulations on your purchase of an AE Techron CIS-25 test system, designed for use in the Aviation industry for EMC testing. The CIS-25 Test Kit combines into a single, complete package the items needed to accurately test to important Aviation standards like DO-160 sections 18 and 19.

Included with the kit are three coupling transformers (T1000, T2000, and T3700), the CR 600 Chattering Relay accessory, and a secure storage cabinet to keep the equipment safe.

The CIS-25 kit also comes with two hours of expert consulting provided by EMC Specialist Patrick G Andre, who will answer any questions you might have about set-up or testing.

The DSR 100-25 test system, which is included with the CIS-25 Test Kit, has power in reserve. Each of our DSR Series models provides continuous DC power as rated, and is able to provide 4X rated power for in-rush testing up to 200 ms (such as is required in DO 160 Section 16). Plus, the DSR 100-25 system includes the complete 3110A Standard's Library, so the CIS-25 Test Kit can be used for many other tests.*

The equipment is easy to set up and use; all elements in the kit are robust and will provide you with many years of trouble-free service.

The AE Techron brand is known throughout the world for its robust precision amplifiers and test systems as well as its product service and support.

1.1 Capabilities

The CIS-25 meets the requirements for testing to these Standards:

- DO-160 Section 18
- DO-160 Section 19
- Airbus ABD0100.1.8
- MIL STD 461 (CS101)

1.2 Disclaimer

Although AE Techron has made substantial effort to ensure the accuracy of the Standards' test files (SWG files), which are included with the DSR 100-series cabinet, no warranty, expressed or implied, is made regarding accuracy, adequacy, completeness, legality, reliability or usefulness of the information provided. It is the responsibility of the user to ensure the accuracy and applicability of these test files for their intended purposes.

***Some Standards' tests included in the 3110A Library may require voltages above the maximum voltage available in your DSR 100-25 system. To run those tests, connect the 3110A to a different amplifier or amplifier system that can generate the required voltage.**

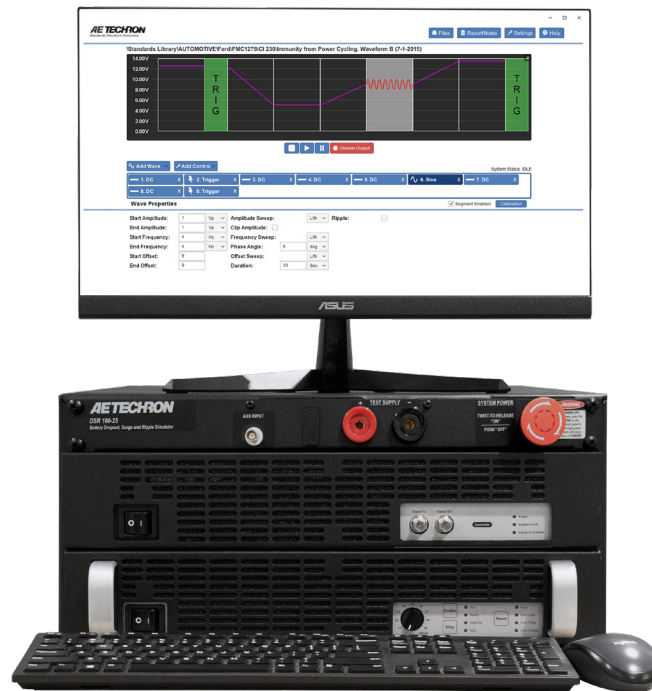

DSR 100-25

Dropout, Surge, Ripple Simulator and AC/DC Voltage Source

Operation Manual

Three-Year, No-Fault Warranty

SUMMARY OF WARRANTY

AE TECHRON INC., of Elkhart, Indiana (Warrantor) warrants to you, the ORIGINAL COMMERCIAL PURCHASER and ANY SUBSEQUENT OWNER of each NEW **AE TECHRON INC. product, for a period of three (3) years from the date of purchase, by the original purchaser (warranty period) that the product is free of defects in materials and workmanship and will meet or exceed all advertised specifications for such a product. We further warrant the new AE Techron product regardless of the reason for failure, except as excluded in the Warranty.**

ITEMS EXCLUDED FROM WARRANTY

This AE Techron Warranty is in effect only for failure of a new AE Techron product which occurred within the Warranty Period. It does not cover any product which has been damaged because of any intentional misuse, or loss which is covered under any of your insurance contracts. This warranty does not extend to any product on which the serial number has been defaced, altered, or removed. It does not cover damage to loads or any other products or accessories resulting from **AE TECHRON INC.** product failure. It does not cover defects or damage caused by the use of unauthorized modifications, accessories, parts, or service.

WHAT WE WILL DO

We will remedy any defect, regardless of the reason for failure (except as excluded), by repair or replacement, at our sole discretion. Warranty work can only be performed at our authorized service centers or at our factory.

Expenses in remedying the defect will be borne by **AE TECHRON INC.**, including one-way surface freight shipping costs within the United States. (Purchaser must bear the expense of shipping the product between any foreign country and the port of entry in the United States and all taxes, duties, and other customs fees for such foreign shipments.)

HOW TO OBTAIN WARRANTY SERVICE

When you notify us or one of our authorized service centers of your need for warranty service, you will receive an authorization to return the product for service. All components must be shipped in a factory pack or equivalent which, if needed, may be obtained

from us for a nominal charge. We will take corrective actions and return the product to you within three weeks of the date of receipt of the defective product, or will make available to you a product of equal or better performance on temporary loan until your product can be repaired or replaced and returned to you. If the repairs made by us are not satisfactory, notify us immediately.

DISCLAIMER OF CONSEQUENTIAL AND INCIDENTAL DAMAGES

You are not entitled to recover from us any consequential or incidental damages resulting from any defect in our product. This includes any damage to another product or products resulting from such a defect.

WARRANTY ALTERATIONS

No person has the authority to enlarge, amend, or modify this warranty. The warranty is not extended by the length of time for which you are deprived of the use of this product. Repairs and replacement parts provided under the terms of this warranty shall carry only the unexpired portion of this warranty.

DESIGN CHANGES

We reserve the right to change the design of any product from time to time without notice and with no obligation to make corresponding changes in products previously manufactured.

LEGAL REMEDIES OF PURCHASER

There is no warranty that extends beyond the terms hereof. This written warranty is given in lieu of any oral or implied warranties not contained herein. We disclaim all implied warranties, including, without limitation, any warranties of merchantability or fitness for a particular purpose. No action to enforce this Warranty shall be commenced later than ninety (90) days after expiration of the warranty period. This statement of warranty supersedes any others contained in this manual for AE Techron products.

AE TECHRON INC. **Customer Service Department**

2507 Warren St. Elkhart, IN, 46516, U.S.A.
(574) 295-9495
www.aetechron.com

Contents

1	About the DSR 100-25 Test System	5
1.1	Features	5
1.2	Disclaimer.....	5
2	System Setup.....	6
2.1	Safety First.....	6
2.2	Unpacking and Installing	6
2.3	Configuration Options.....	6
2.4	Connections	7
2.5	Startup Procedure	8
2.6	Shutdown Procedure.....	8
3	Operation	10
3.1	System Controls and Connectors.....	10
3.2	3110A Operation.....	11
3.3	Amplifier Module Operation	12
4	Applications.....	15
4.1	Configure for Low-Voltage Testing	15
4.2	Using an External Signal Source.....	16
4.3	Using an External Amplifier	17
5	Maintenance	19
5.1	Clean Filter and Grill on Amplifier Module.....	19
6	Troubleshooting	20
6.1	Factory Service:	21

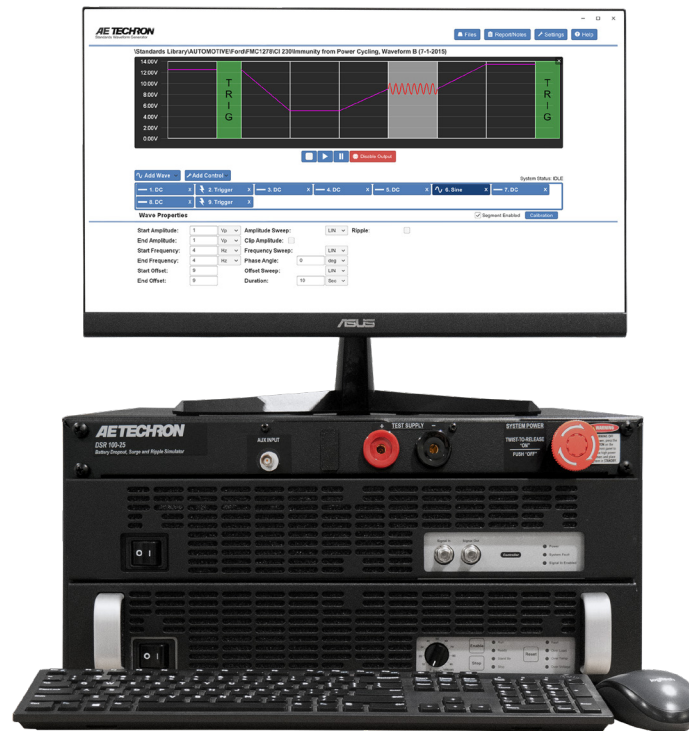

Figure 1.1 – DSR 100-25 System

1 About the DSR 100-25 Test System

Congratulations on your purchase of an AE Techron DSR 100-25 test system, designed for use in EMC testing as a dropout, surge, ripple simulator and AC/DC voltage source. A DSR 100-25 test system provides a complete, single-box solution for immunity testing. It includes a simple-to-use yet powerful 3110A Standards Waveform Generator matched with an industry leading power supply technology and comes with an extensive library of tests for many automotive and aviation standards.*

The DSR 100-25 is 4-quadrant, allowing it to source and sink current. It has power in reserve; it is able to provide 4X rated power for in-rush testing up to 200 ms, as is required in DO 160 Section 16.

The AE Techron brand is known throughout the world for its robust precision amplifiers and test systems as well as its product service and support.

***Some Standards' tests included in the 3110A Library may require voltages above the maximum voltage available in your DSR 100-25 system. To run those tests, connect the 3110A to a different amplifier or amplifier system that can generate the required voltage.**

1.1 Features

- Includes a library of 3000+ pre-entered Automotive and Aviation Standards' test routines
- Operate as a free-standing system using the included monitor, keyboard and mouse, or control via LAN
- Very easy to modify existing tests or build new test sequences
- Can function as a controller or node in a larger test system via built-in LAN and GPIO controls

1.2 Disclaimer

Although AE Techron has made substantial effort to ensure the accuracy of the Standards' test files (SWG files), which are included with the DSR 100-series cabinet, no warranty, expressed or implied, is made regarding accuracy, adequacy, completeness, legality, reliability or usefulness of the information provided. It is the responsibility of the user to ensure the accuracy and applicability of these test files for their intended purposes.

2 System Setup

2.1 Safety First

Throughout these instructions, special emphasis is placed on good safety practices. The following graphics are used to highlight certain topics that require extra precaution.

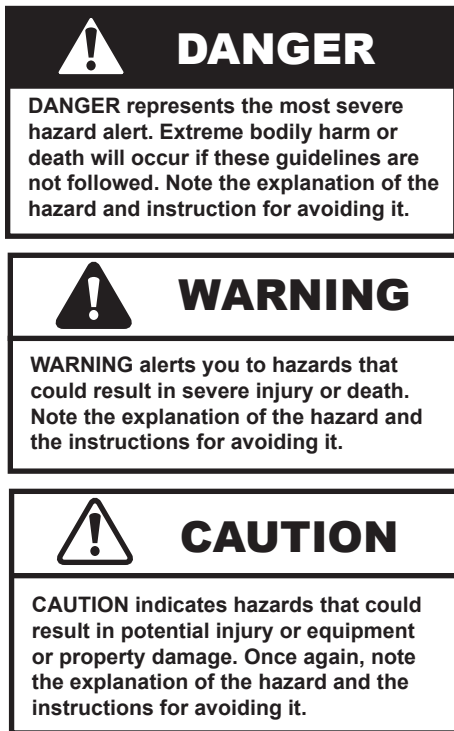

2.2 Unpacking and Installing

Carefully unpack the DSR 100-25 and accessories from the two cartons and visually inspect the contents for damage. All units are tested and inspected for damage before leaving the factory, so if any damage is found, please notify the shipping company immediately. Save the shipping cartons and materials as evidence of damage.

2.2.1 Check Contents

In addition to the DSR 100-25 system, your shipment should include the following:

1. LCD monitor
2. Monitor power cord
3. HDMI-to-DVI monitor cable
4. USB mouse
5. USB keyboard
6. Mating Supercon connectors (2)
7. Ethernet cable
8. Mouse pad
9. System power cord
10. Quick Start Guide
11. DSR 100-25 Operation Manual on USB drive

2.2.2 DSR System Location

The DSR 100-25's case features heavy-duty handles to allow the user to move the system from bench-top to bench-top. Locate the system near a 120V, 20AAC supply,

2.3 Configuration Options

Your DSR 100-25 system includes an integrated 3110A Standards Waveform Generator that contains an extensive library of tests for many automotive, aviation, and industry standards. The 3110A provides a powerful yet simple-to-use interface to help streamline the testing process. 3110A test files (.swg) are easy to link, build from scratch, or customize using time-saving controls like triggers and loops with changing variables. Plus, the 3110A's intuitive, drag-and-drop interface makes it easy to modify existing tests or build new tests.

The 3110A can produce standard signals and waveforms with or without a DC offset. Frequency, amplitude and DC offset can be fixed or swept, and sinewave sweeps can be linear, logarithmic or exponential. It can create dropouts and surges and can also produce ripple waveforms of up to 1 MHz

As it ships from the factory, the DSR 100-25 is capable of performing thousands of different EMC immunity tests. However, in order to meet some test requirements, changes to the DSR system's configuration may be needed.

These alternative configurations include:

Low-Voltage Testing: Standards Tests having a maximum voltage of less than 30V may require an increase in the signal-to-noise performance of the DSR 100-25 system in order to achieve accurate results.

External Signal Source: The DSR 100-25 system can be configured to use an external signal source in place of the internal 3110A signal generator,

External 7000 Series Amplifier: The DSR 100-25 system can be configured to use an external AE Techron 7000 Series amplifier in place of the internal amplifier.

The settings and connections required for these special uses are detailed in the **Applications** section of this manual.

2.4 Connections

Make the following connections to prepare the DSR 100-25 system for standard operation.

2.4.1 Connect Signal Input

Using a standard BNC cable, connect from the Signal Out BNC connector located on the front panel of the 3110A to the Aux Input BNC connector located on the DSR 100-25's I/O panel. See **Figure 2.1**.

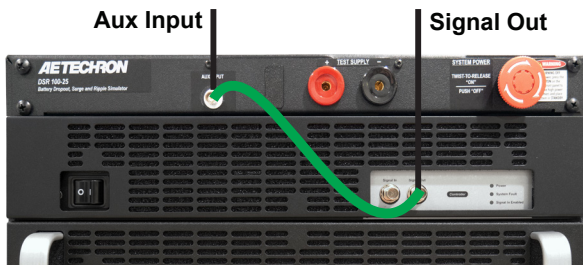

Figure 2.1 – Signal Input Connections

2.4.2 Connect to the Device Under Test

Make sure the DSR 100-25 system is turned off and AC power is disconnected. Using the supplied mating output connectors and wiring appropriate for your application, connect from the DSR 100-25

! WARNING

ELECTRIC SHOCK HAZARD.

Output potentials can be lethal. Make connections only with AC Power unplugged or switched off at the source and the system's AC power switch in the OFF position.

system's front-panel positive and negative Test Supply connectors to the device under test. See **Figure 2.2**.

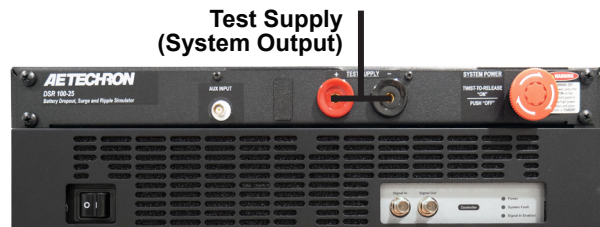

Figure 2.2 – Test Supply Connectors

2.4.3 Connect the 3110 Accessories

Complete the following steps to connect the 3110A cables and accessories provided to the DSR 100-25 back panel. Refer to **Figure 2.3** for component locations.

- A. Plug the USB keyboard into the USB port labeled KEYBOARD on the DSR 100-25 back panel.

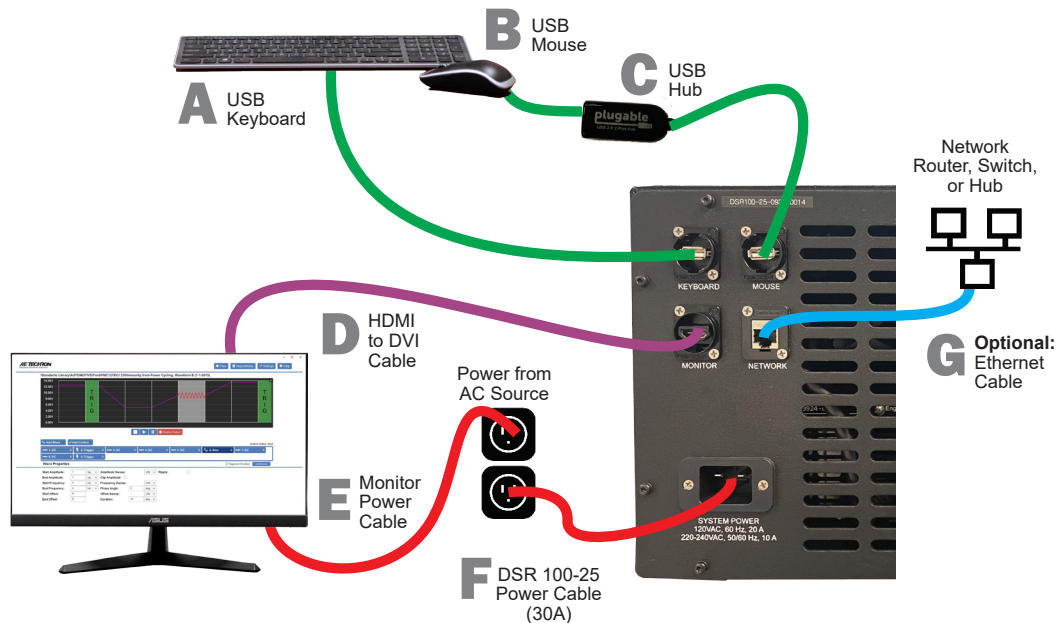

Figure 2.3 – Connecting the 3110A Cables and Accessories on the DSR 100-25

- F. Plug the DSR 100-25 power cord into the power connector located on the DSR 100-25 back panel, and then connect the cord to a 20A power source.
- G. **OPTIONAL:** To connect the DSR 100-25 to be accessed and controlled through a network: Plug the Ethernet cable to the Ethernet port labeled NETWORK, and then plug the Ethernet cable into a router, switch or hub on the network. Refer to the topic “Remote Operation” in the **3110A Help** files for more information.

Note on Network Control of the 3110A: After network control of the 3110A has been implemented, the monitor, keyboard and mouse can be disconnected from the 3110A and the system can be operated remotely. See the topic “Remote Operation” in the **3110A Help** files for more information.

2.5 Startup Procedure

Complete the following steps to power up the DSR system.

1. Use the monitor’s power switch (last button on the right) to turn on the monitor.
2. Check the power/breaker switch on the 3110A and the amplifier module. Make sure both units are switched ON. See **Figure 2.4**.
3. Check the amplifier modules’s gain control and make sure it is fully clockwise. See **Figure 2.5**.
4. Depress the SYSTEM POWER switch to turn the DSR system ON. See **Figure 2.6**.
5. Wait for the 3110A interface to load (loading will take up to 30 seconds). Press the Help button to access this manual from within the program.
6. Run the System Calibration test to determine the proper settings for your system. Note that the default system gain for the DSR 100-25 will be 10. See the “**Calibration**” section in the **3110A Help** files for more information.

2.6 Shutdown Procedure

IMPORTANT: Any powered amplifiers (Including the integrated amplifier module or any external amplifiers) that are connected to the

3110 Standards Waveform Generator



Amplifier Module



Figure 2.4 – Locations of Power/Breaker Switches for System Modules

Amplifier Module



Figure 2.5 – Gain Control Location



Figure 2.6 – System Power Switch Location

3110A must first be disabled before shutting down the 3110A or DSR 100-25 System. Failure to follow the proper shutdown procedure can result in damage to the amplifiers or any connected load/ DUT.

Complete the following to safely shut down a 3110/ amplifier combination or DSR System:

1. Make sure any amplifiers connected to the system are disabled, including the integrated amplifier module in the DSR system and/or

any connected external amplifiers or amplifier systems. You can turn the integrated amplifier module off by using the module's power switch. See **Figure 2.4** for power switch location.

To quickly disable external AE Techron 7000 series amplifiers, press the Stop button on the front panel of the amplifier or on any amplifier

in an amplifier system to place all connected units in Standby mode.

2. After all amplifiers have been disabled, turn the system OFF by pressing the System Power button.

NOTE: If the 3110A is not connected to any amplifiers, it can be safely shut down by simply pressing the 3110A front-panel power switch.

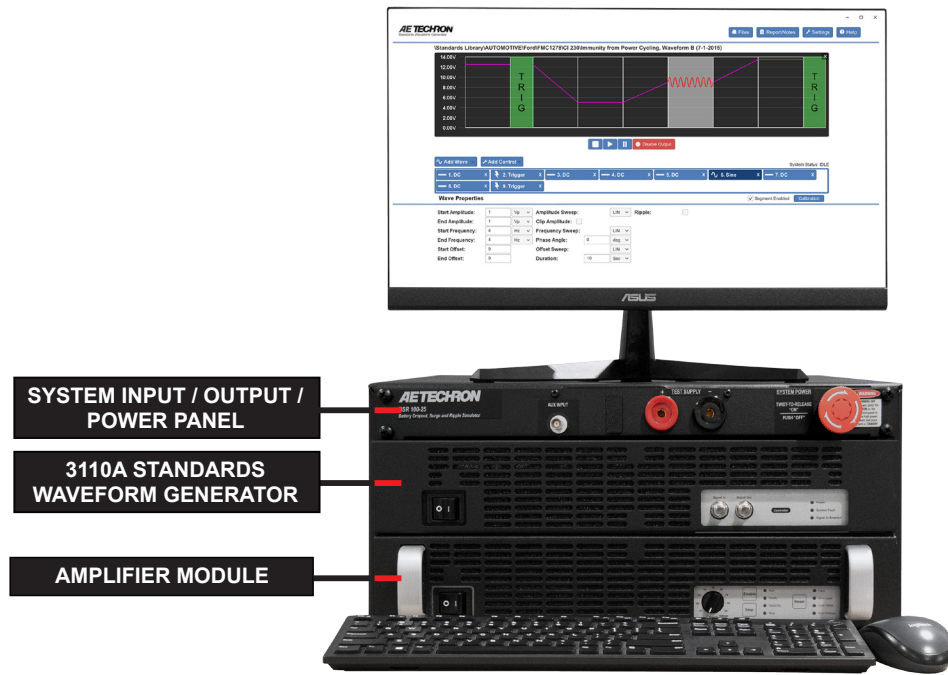

Figure 3.1 – DSR 100-25 Module Locations

3 Operation

IMPORTANT: Before operating the DSR 100-25 system, the **3110A System Calibration Procedures** should be performed to verify the correct System Gain and DC Offset settings for your system. See the topic “System Calibration” in the **3110A Help** files for more information.

System Overview

Your DSR 100-25 system provides one integrated signal generation device to produce the test sequences, and one amplifier module to reproduce and amplify the output signal. The location of each module is specified in **Figure 3.1**.

3.1 System Controls and Connectors

System level controls and connectors are located on the Input/Output/Power panel installed at the

top front of the unit. Refer to **Figure 3.2** for component locations.

Aux Input: An unbalanced BNC connector is used to provide the input signal to the DSR 100-25 system from the 3110A or an external signal generator.

Test Supply (System Output): A pair of high-current connectors are provided to supply the test signal to the DUT. Connector type, either Anderson or Supercon, must be specified when ordering. Mating connectors are provided with the unit.

System Power: A power/emergency stop switch is provided which controls the power supply to the system and all system components. Turn clockwise to power the system on. Press in to power off the system.

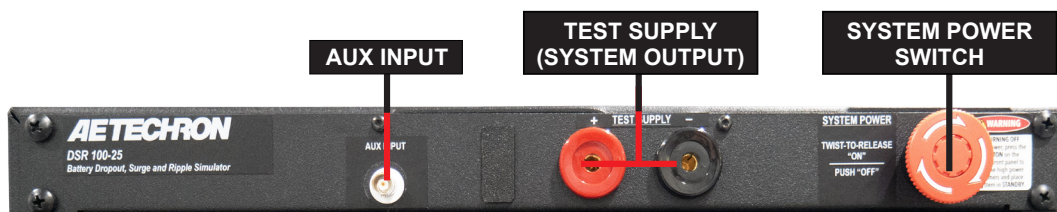

Figure 3.2 – DSR 100-25 System Controls and Connectors

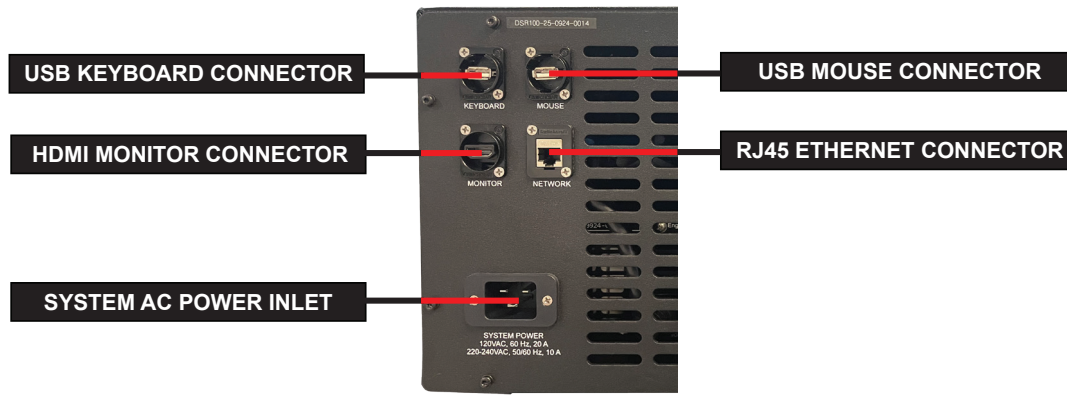

Figure 3.3 – Back-Panel Connectors for System Power and 3110A Accessories

3.2 3110A Operation

The AE Techron 3110A Standards Waveform Generator provides an intuitive interface for waveform sequence creation and generation. The following sections describe the 3110A connection and operation.

3.2.1 3110A Accessories

The accessories required for operation of the 3110A are connected using the Accessories panel located on the cabinet rear. Refer to **Figure 3.3** for connector locations.

3.2.2 3110A Front-Panel Controls, Connectors, and Indicators

See **Figure 3.4** for item locations.

Power Switch: The Power switch controls the AC mains power to the 3110A. Switch to the ON position (I) to turn the 3110A on. Switch to the OFF position (O) to turn the 3110A off..

Signal In (Diagnostics Port): An unbalanced BNC connector is available for diagnostic use by Factory Service..

Signal Out: An unbalanced BNC connector is used to provide the signal from the 3110A to an external amplifier.

Power Indicator: The LED will light when the 3110A has AC power and is ready for operation.

System Fault Indicator: The LED will light if a fault condition occurs in the 3110A system.

Signal In Enabled: The LED will light when diagnostic equipment connected to the 3110A's Signal In Port and enabled.

3.2.3 3110A Software Basic Operation

To select a pre-programmed test from the Standard's Library, simply use the Files button to open the files window and select the test file. Refer to **Figure 3.5** for on-screen controls' locations.

Custom test files can be created by adding waveforms and controls to the test sequence display. For help in getting up and running quickly on the 3110A, please see the "3110A Tutorials" section in the **3110A Help** files.

Please also refer to the **3110A Help** files for general operation and troubleshooting information, The **Help** files are available by selecting the Help button from the 3110A main window. They are also provided in pdf format on the USB drive shipped with your DSR 100 system, or on the AE Techron website at aetechron.com.

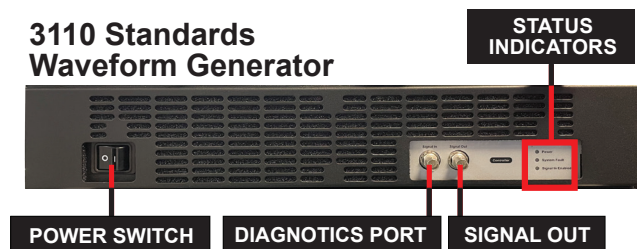

Figure 3.4 – 3110A Front-Panel Controls, Connectors, and Indicators

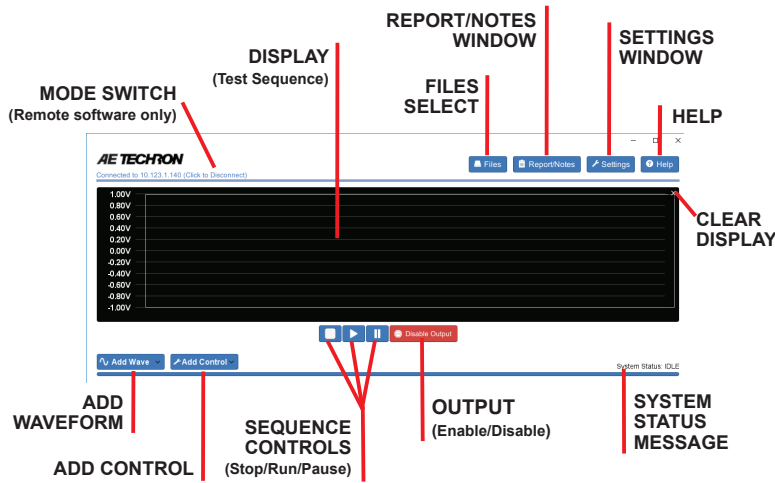

Figure 3.5 – AE Techron 3110A On-screen Controls

3.3 Amplifier Module Operation

Your DSR system contains one amplifier module to provide the high-current output required for many Standards’ tests. The following sections describe the controls and indicators found on the DSR 100-25 amplifier module.

3.3.1 Front-Panel Controls

See **Figure 3.6** for item locations.

Power/Breaker Switch - The Power/Breaker Switch controls the AC mains power to the amplifier module. Switch to the ON position (I) to turn the module on. Switch to the OFF position (O) to turn the module off.

The Power/Breaker Switch also serves as a Breaker. When the Breaker is tripped, this switch moves to a neutral position between ON and OFF. To reset the Breaker, turn the Power/Breaker Switch OFF (O) and then turn it back ON (I).

Gain Control - The Gain Control knob increases/ decreases the gain from 0 – 100% of the overall Gain. Turn the Gain Control fully clockwise for maximum output from the amplifier module.

Input Buttons

Three push buttons on the amplifier module’s front panel control basic operation of the module.

Enable – Enable will release the amplifier module from Stop mode and place it in Run mode (both

Ready and Run LEDs will be lit). When the amplifier module is placed in Run mode, the high-voltage transformers will be energized and the module will amplify the input signal.

Stop – Stop will place the amplifier module in Stop mode (both Standby and Stop LEDs will be lit). When an amplifier module is in Stop mode, the low-voltage transformer is energized but the high-voltage transformers are not.

Reset – When a fault condition occurs, the amplifier module may be placed in Standby mode (Standby LED will be lit), depending on the fault condition. To release the module from Standby mode, clear the fault condition and then press the Reset button. If the amplifier module is in Run mode when the fault condition occurs, pressing the Reset button will return the module to Run mode. If the amplifier module is in Stop mode when the fault condition occurs, pressing the Reset button will return the module to Stop mode.

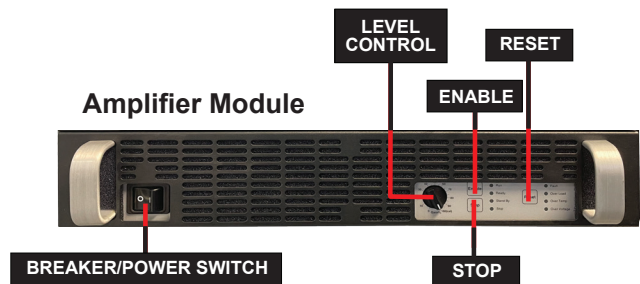

Figure 3.6 – Amplifier Module Controls



Figure 3.7 – Amplifier Module Status Indicators

3.3.2 Front-Panel Status Indicators

Please refer to **Figure 3.7** for item locations.

Main Status Indicators

Four Main Status indicators are located on the amplifier module’s front-panel. These LEDs monitor the internal conditions of the module and indicate the current state of operation. The chart in **Figure 3.8** details the operational modes indicated by the Main Status indicators.

Figure 3.8 – Main Status Indicators

● ● ● Indicator is lit ● Indicator is not lit ○ Indicator may be lit

Main Status Indicators	State of Operation	Action Needed to Return to Run Mode
<ul style="list-style-type: none"> ● Run ● Ready ● Standby ● Stop 	<p>Run mode: The amplifier module’s high-voltage transformers are energized and the unit will amplify the input signal. Run mode is initiated by: (1) the Enable push button when the amplifier module is in Standby mode, or (2) when the amplifier module powers up..</p>	N/A
<ul style="list-style-type: none"> ● Run ○ Ready ● Standby ● Stop 	<p>Standby mode: Standby mode indicates that the amplifier module is functioning properly and all Fault Status modes are clear, but it is being held in Standby by an external condition. The amplifier module will enter Standby mode briefly after powering up, and then will move automatically into Run mode. In Standby mode, the amplifier module’s low-voltage transformer is energized but the high-voltage transformers are not.</p>	If the amplifier module remains in Standby mode, it may require servicing. Please contact AE Techron Technical Support.
<ul style="list-style-type: none"> ● Run ● Ready ● Standby ● Stop 	<p>Stop mode: When the Stop button on the amplifier front panel is pressed, the amplifier will enter Stop mode. In Stop mode, the amplifier’s low-voltage transformer is energized but the high-voltage transformers are not.</p>	To release the amplifier from Stop mode, press the Enable button.

Fault Status Indicators

Four Fault Status indicators are located on the amplifier module’s front panel. These LEDs monitor the internal conditions of the module and will illuminate when a fault condition occurs. Depending on the fault condition, the DSR 100-25 system

may be placed in Standby mode when a fault condition occurs. Refer to the chart in **Figure 3.9** to determine the fault condition being indicated and the action required to clear the fault condition.

Figure 3.9 – Fault Status Indicators

● ● ● Indicator is lit ● Indicator is not lit ○ Indicator may be lit

Main Status Indicators	Fault Status Indicators	State of Operation	Action Needed to Clear Fault Condition and Return to Run Mode
<ul style="list-style-type: none"> ● Run ● Ready ● Standby ● Stop 	<ul style="list-style-type: none"> ● Fault ● Over Load ● Over Temp ● Over Voltage 	<p>Output Fault status: This indicates that an Output Fault condition has occurred and the amplifier module has been placed in Standby mode. The Fault indicator will light under two conditions: 1) High-frequency oscillation is causing high shoot-through current; or 2) An output transistor has shorted, causing the output fault condition.</p>	<p>This fault condition cannot be cleared using the front-panel Reset button. See the Troubleshooting section for more information on diagnosing and clearing this fault condition.</p>

Main Status Indicators	Fault Status Indicators	State of Operation	Action Needed to Clear Fault Condition and Return to Run Mode
<ul style="list-style-type: none"> ● Run ● Ready ○ Standby ● Stop 	<ul style="list-style-type: none"> ● Fault ● Over Load ● Over Temp ● Over Voltage 	<p>Over Load status: This indicates that the output of the dsr 100-25 system could not follow the input signal due to voltage or current limits. Under normal operation with the factory-default settings, an Over Load condition will not place the amplifier module in Standby mode.</p>	<p>To remedy the Over Load fault during operation, turn down the level of the input signal until the Over Load indicator turns off.</p>
<ul style="list-style-type: none"> ● Run ● Ready ● Standby ● Stop 	<ul style="list-style-type: none"> ● Fault ● Over Load ○ Over Temp ● Over Voltage 	<p>Over Temp status: The system monitors the temperature inside the amplifier module's high-voltage transformers, low-voltage transformer and in the output stage heat sinks. The Over Temp indicator will light and the amplifier module will be placed in Standby mode when the temperature sensors detect a condition that would damage the module. If the Over Temp pulse is extremely short, as in the case of defective wiring or switches, the Over Temp LED may be lit too briefly to observe.</p>	<p>To reset after an Over Temp fault has occurred, make sure the fans are running in the amplifier module, and then remove the input signal from the amplifier module. Allow the fans to run for about 5 to 15 minutes, and then push and hold the Reset button until the Standby LED turns off. Release the Reset button to return the system to Run mode. See the Troubleshooting section for information on correcting the cause of an Over Temp fault condition.</p>
<ul style="list-style-type: none"> ● Run ● Ready ● Standby ● Stop 	<ul style="list-style-type: none"> ● Fault ● Over Load ● Over Temp ● Over Voltage 	<p>Over Voltage status: This indicates that the AC mains voltage is more than +10% of nominal. The amplifier module will be forced to Standby when an Over Voltage condition occurs. When the Over Voltage condition is cleared, the module will automatically return to Run mode.</p>	<p>To clear an Over Voltage fault condition, the AC mains must be brought down to the nominal value. Once the Over Voltage condition has been cleared, press the Reset button to return the amplifier module to Run mode. If the module does not return to Run mode, it may require servicing. Please see the Troubleshooting section for more information.</p>

4 Applications

The DSR 100-25 has been configured at the factory for use as a general-purpose system capable of generating the test signal for a wide range of Standards' testing.

When the **default** configuration is used, the 3110A controller in the DSR system will produce the test waveform and the amplifier module in the DSR system will amplify the test signal.

Three additional configurations are detailed in this manual:

Low-Voltage Testing: Standards Tests having a maximum voltage of less than 30V may require an increase in the signal-to-noise performance of the DSR 100 system in order to achieve accurate results.

External Signal Source: The DSR 100-25 system can be configured to use an external signal source in place of the internal 3110A signal generator,

External Amplifier: The DSR 100-25 system can be configured to use an external amplifier in place of the internal amplifier. Note that the amplifier should be an AE Techron 7000 Series or equivalent.

Each alternate use requires different setup and startup procedures. Please refer to the following instructions to setup and operate the DSR 100-25 system according to your requirements.

4.1 Configure for Low-Voltage Testing

Standards Tests having a maximum voltage of less than 30V may require an increase in the signal-to-noise performance of the DSR 100-25 system in order to achieve accurate results. This can be achieved by lowering the DSR 100-25's gain. Only a few test sequences will require use of this configuration. **NOTE: When using this configuration, the DSR 100-25's system gain will be 6.**

4.1.1 Setup Procedure

Complete the following steps to configure and connect the DSR 100-25 system and other required equipment.

1. Adjust the Amplifier Module's DIP Switch Setting:

Open the system's access door located on the back of the unit. Find the bank of eight (8) DIP switches located on the amplifier module's back panel. See **Figure 4.1**.

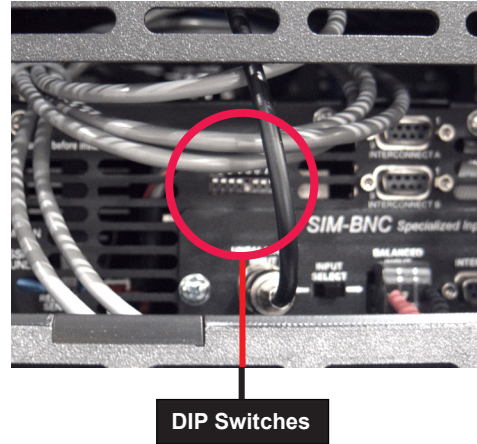

Figure 4.1 – Location of Amplifier Module's DIP Switches

Move DIP switch #4 to the DOWN position. (Note: DIP switches are numbered from left to right).

2. Connect 3110A Accessories:

If not already connected, follow the instructions in the **System Setup** section of this manual to connect the 3110A accessories.

3. Connect the Signal Source:

Using a standard BNC cable, connect from the Signal Out BNC connector located on the front panel of the 3110A to the Aux Input BNC connector located on the DSR 100-25's I/O panel. See **Figure 4.2**.

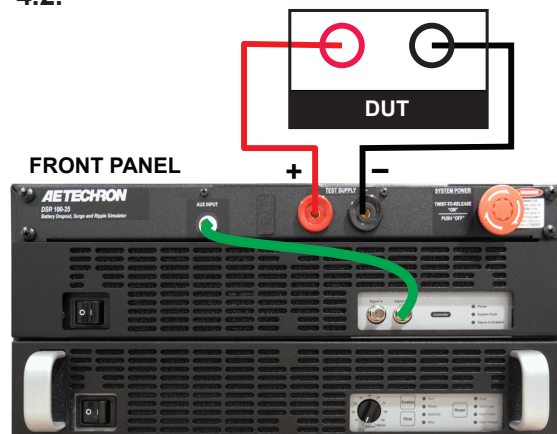

Figure 4.2 – Connections for Low-Voltage Testing



Figure 4.3 – Locations of Controls for Low-Voltage Testing

4. **Connect the Outputs:** Using the supplied mating output connectors and wiring appropriate for your application, connect from the DSR 100-25's positive and negative test supply connectors to the device under test. See **Figure 4.2**.

4.1.2 Startup Procedure:

Complete the following to enable the DSR 100-25 system: Refer to **Figure 4.3** for control locations.

1. Make sure the breaker/power switch on the amplifier module is in the ON position.
2. Make sure the power switch on the 3110A controller is in the ON position.
3. Make sure the Gain control on the amplifier module is fully clockwise.
4. Turn the System Power switch clockwise to turn the DSR system ON.

4.2 Using an External Signal Source

This application uses an external signal source and the DSR system's internal amplifier. **NOTE: When using this configuration, the DSR 100-25's system gain will be 20.**

4.2.1 Setup Procedure

Complete the following steps to connect the DSR 100-25 system and other required equipment.

1. **Connect 3110A Accessories:** If not already connected, follow the instructions in the **System Setup** section of this manual to connect the 3110A accessories.

2. **Connect the Signal Source:** Use a BNC cable to connect from the signal output connector on your external signal source to the DSR100-25's BNC connector labeled Aux Input. See **Figure 4.4**.
3. **Connect the Outputs:** Using the supplied mating output connectors and wiring appropriate for your application, connect from the DSR 100-25's positive and negative test supply connectors to the device under test. See **Figure 4.4**.

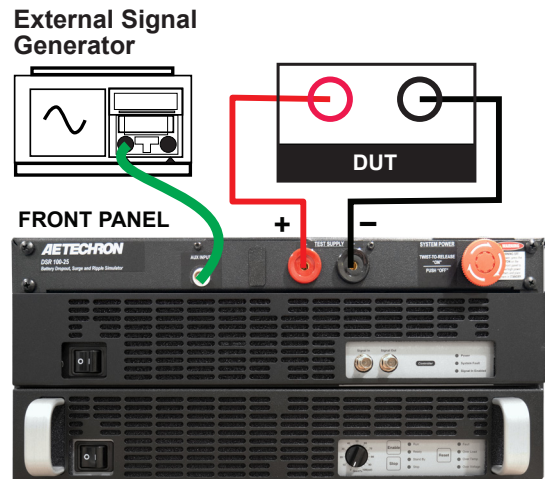

Figure 4.4 – Connecting an External Signal Source

4.2.2 Startup Procedure:

Complete the following to enable the DSR 100-25 system: Refer to **Figure 4.5** for control locations.

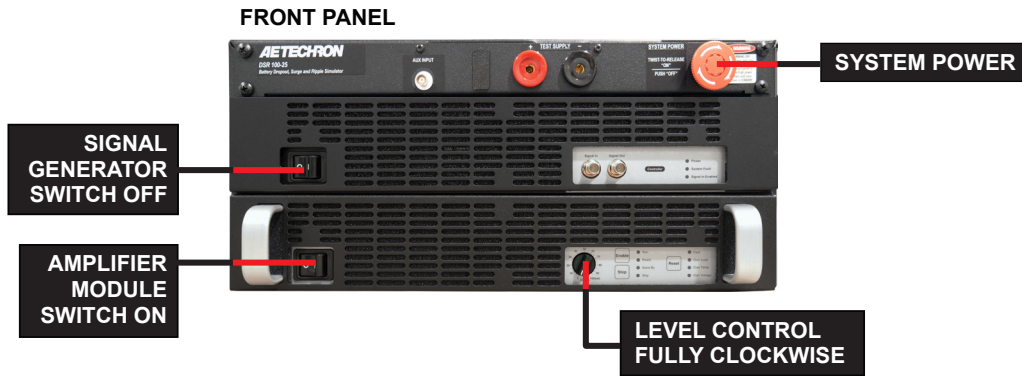

Figure 4.5 – Locations of Controls for Operation with an External Signal Source

1. Make sure the breaker/power switch on the amplifier module is in the ON position.
2. Make sure the power switch on the 3110A controller is in the OFF position.
3. Make sure the Gain control on the amplifier module is fully clockwise.
4. Turn the System Power switch to turn the DSR system ON.
5. Turn your external signal source ON and enable your desired signal. Consult the manual of your external signal source, if needed, for instructions on operating the unit.

4.3 Using an External Amplifier

This application uses an external amplifier and the DSR system’s internal waveform generator.

NOTE: Consult your amplifier specifications to determine the system gain.

4.3.1 Setup Procedure

Complete the following steps to connect the DSR 100-25 system and other required equipment.

1. **Connect 3110A Accessories:** If not already connected, follow the instructions in the **System Setup** section of this manual to connect the 3110A accessories.
2. **Connect External Amplifier:** Use a BNC cable to connect from the BNC connector labeled Signal Out located on the DSR 100-25 3110A waveform generator’s front panel to the signal input connector on the external amplifier. See **Figure 4.6**.

3. **Connect the Outputs:** Using the supplied mating output connectors and wiring appropriate for your application, connect from the external amplifier’s positive and negative output connectors to the device under test. See **Figure 4.6**.

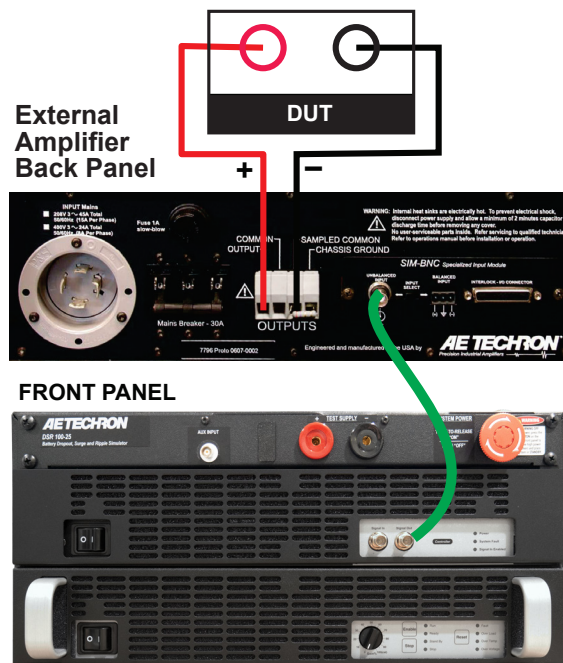

Figure 4.6 – Connecting an External Amplifier

4.3.2 Startup Procedure:

Complete the following to enable the DSR 100-25 system: Refer to **Figure 4.7** for control locations.

1. Use the monitor’s power switch (last button on the right) to turn on the monitor.
2. Make sure the breaker/power switch on the amplifier module is in the OFF position.

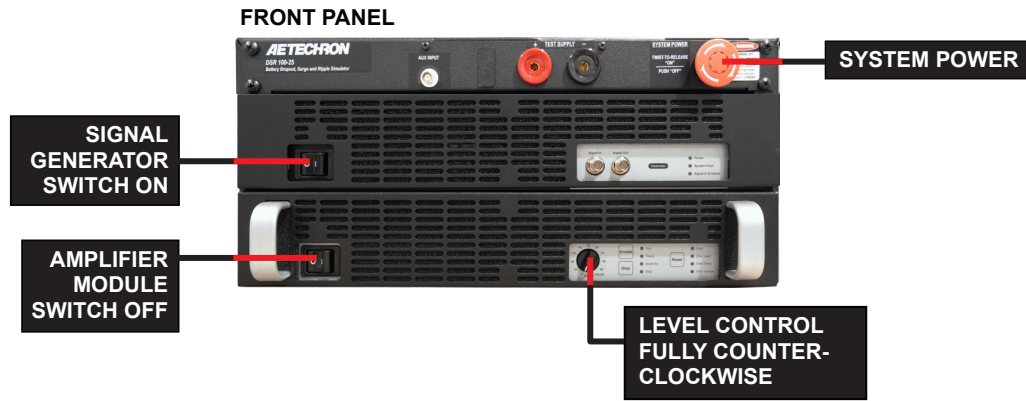

Figure 4.7 – Locations of Controls for Operation with an External Amplifier

3. Make sure the power switch on the 3110A controller is in the ON position.
4. Make sure the Gain control on the amplifier module is fully counter-clockwise.
5. Turn the System Power switch to turn the DSR system ON.
6. Turn your external amplifier ON. Consult the manual of your external amplifier, if needed, for instructions on operating the unit.
7. Wait for the 3110A software to load (loading will take up to 30 seconds). Then open the on-screen Help system for help with System Calibration and Operation.

5 Maintenance

Simple maintenance can be performed by the user to help keep the equipment operational. The following routine maintenance is designed to prevent problems before they occur. See the “Troubleshooting” section for recommendations for restoring the equipment to operation after an error condition has occurred.

Preventative maintenance is recommended after the first 250 hours of operation, and every three months or 250 hours thereafter. If the equipment environment is dirty or dusty, preventative maintenance should be performed more frequently.

The procedures outlined in this section are directed towards an experienced electronics technician; it assumes that the technician has knowledge of typical electronics safety and maintenance procedures.

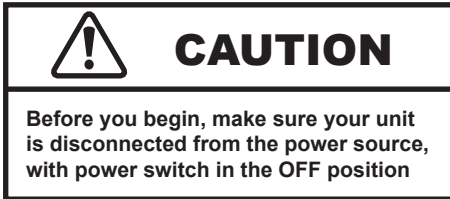

5.1 Clean Filter and Grill on Amplifier Module

Tools Required

The recommended equipment and supplies needed to perform the functions required for this task are described below.

- Vacuum cleaner
- Damp cloth (use water only or a mild soap diluted in water)

To ensure adequate cooling and maximum efficiency of the internal cooling fans, the amplifier's front grill should be cleaned periodically. To clean the amplifier grill and filter, complete the following steps:

1. Turn completely down (counter-clockwise) all level controls and turn the amplifier OFF. Disconnect the amplifier from its power source.
2. Using a vacuum cleaner, vacuum the front ventilation grill.
3. Remove the front grill by pulling the grill firmly away from the amplifier.
4. Remove the filter and vacuum. You can also clean the filter using mild soap and water. **IMPORTANT:** Make sure the filter is completely dry before reinstalling in the amplifier.
5. Using a damp cloth, clean the front ventilation grill. Dry with a clean cloth or allow to air dry. **IMPORTANT:** Grill should be completely dry before plugging in or restarting amplifier.
6. Reinstall the filter and replace the amplifier front grill.



6 Troubleshooting

If the DSR 100-25 system is not operating correctly, review the topics below for help with troubleshooting the problem. If the condition or error you are experiencing is not listed below, please contact **AE Techron Technical Support** at 574-295-9495 for additional help.

PROBLEM: The system has no signal output.

A: Check to make sure signal input is being generated using the 3110A Standards Waveform Generator or a stand-alone signal generator.

To see if signal is being generated by the 3110A, access the 3110A SWG software, and check to make sure that output is enabled for the test sequence and that the “Segment Enabled” option is selected for all wave segments.

If using a stand-alone signal generator, check the BNC cable connecting from the signal generator to the AMPLIFIER INPUT DIRECT connector on the front panel of the DSR system. Make sure the connections at both ends are secure.

PROBLEM: System does not power on; no LEDs are lit on the 3110A or the amplifier module.

A: Check that the power cord is completely inserted into the DSR 100-25’s back panel power inlet. Check that the power cord is connected to a power outlet and the AC mains is switched on.

PROBLEM: 3110A unit does not power on.

A: Check the front-panel power switch on the 3110A to make sure the unit is in the ON position.

PROBLEM: The SWG Windows Remote software will not load or will not connect remotely to the 3110A; instead, an error message indicates a “version mismatch.”

A: The 3110A software and the Windows Remote software versions must match for successful interaction between the two modules. See the topic “Updating the 3110A” in the **3110A Help** files for

Amplifier Module



Figure 5.1 – Amplifier Module’s Breaker/Power Switch Location

information about how to install new versions of these modules.

PROBLEM: No LEDs are lit and/or fans are inoperative on the amplifier module.

A: Check the breaker/power switch on the amplifier module to make sure it is in the ON position. See **Figure 6.1**.

PROBLEM: The amplifier module is displaying the Overvoltage Warning message/LED.

A: The amplifier module will protect itself from AC mains voltage that is 10% above the 120V rated operating voltage. If this condition occurs, reduce the AC mains voltage to the proper level. When the line voltage condition is corrected, the amplifier module will automatically reset, and the system will return to Run mode.

If the amplifier module does not automatically reset, the amplifier’s internal transformers may need to be rewired. See the Factory Service information at the end of this section.

PROBLEM: The amplifier module is displaying the Overtemp Warning message/LED.

A: The amplifier module may overheat due to one or both of the following conditions: Excessive power requirements and/or inadequate air flow.

An amplifier module will overheat if the required power exceeds the system’s capabilities. High duty cycles and low-impedance loads are especially prone to cause overheating. To see if excess power requirements are causing overheating, check the following:

1. Check the “Specifications” section in this manual to verify that your application’s requirements fall within the capabilities of this system.
2. Check for faulty output connectors and/or load.
3. Check for undesired DC offset at the output and on the input signal.

If the amplifier module chronically overheats with suitable power and load conditions, then the system or amplifier module may not be receiving adequate airflow. Check the following to determine the cause of inadequate airflow:

1. Check the amplifier module’s air filter for excess dirt and dust. Perform the steps outlined in the “Maintenance” section to clean the amplifier filter.
2. Visually inspect fans to assure correct operation while the system is on. Any inoperative, visibly slow, or reverse-spinning fans should be replaced. Please see the Factory Service information at the end of this section.

An Overtemp condition places the unit in Standby mode. If the Overtemp pulse is extremely short, as in the case of defective wiring or switches, the Overtemp pulse may be too brief to observe.

Resetting After Overtemp: To reset the system after an Overtemp has occurred, make sure fans are running in the amplifier module, then remove the input signal from the system input. Allow the fans to run for five minutes, and then push the Reset button on the amplifier module to reset the system.

PROBLEM: The amplifier module is displaying the Output Device Fault Warning message/LED.

A: The amplifier module contains protection circuitry that disables the module if an output stage is behaving abnormally. This usually indicates an output transistor has shorted.

To clear the Fault condition, follow these steps:

1. Turn off the signal source.
2. Turn off the system
3. Turn the system back on. If the Fault LED

doesn’t illuminate again, turn the signal source on.

4. If the Fault LED is still illuminated and the Fault condition doesn’t clear, return the system for Factory Service. Please see the Factory Service information at the end of this section.

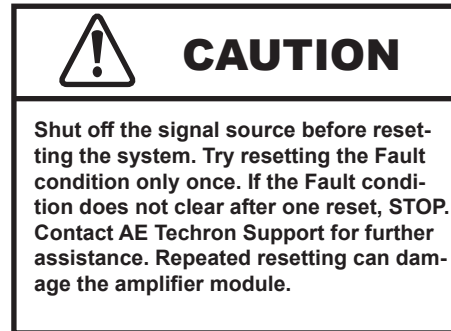

6.1 Factory Service:

If the troubleshooting procedures are unsuccessful, the DSR system may need to be returned for Factory Service. All units under warranty will be serviced free of charge (customer is responsible for one-way shipping charges as well as any custom fees, duties, and/or taxes). Please review the “Warranty” for more information.

All service units must be given Return Authorization Tickets by AE Techron, Inc. before being returned. Return Authorization Tickets can be requested on our website or by contacting our Customer Service Department.

Please take extra care when packaging your unit for repair. It should be returned in its original packaging or a suitable alternative. Replacement packaging materials can be purchased for a nominal fee.

Please send all service units to the following address and be sure to include your Return Authorization Ticket Number on the box.

AE Techron, Inc.

Attn: Service Department / RMA#

2507 Warren Street

Elkhart, IN 46516

AETECHRON



3110A Standards Waveform Generator

Help Files and Product Reference

574.295.9495 | www.aetechron.com
2507 Warren Street, Elkhart, IN 46516

Three-Year, No-Fault Warranty

SUMMARY OF WARRANTY

AE TECHRON INC., of Elkhart, Indiana (Warrantor) warrants to you, the ORIGINAL COMMERCIAL PURCHASER and ANY SUBSEQUENT OWNER of each NEW **AE TECHRON INC. product, for a period of three (3) years from the date of purchase, by the original purchaser (warranty period) that the product is free of defects in materials and workmanship and will meet or exceed all advertised specifications for such a product. We further warrant the new AE Techron product regardless of the reason for failure, except as excluded in the Warranty.**

ITEMS EXCLUDED FROM WARRANTY

This AE Techron Warranty is in effect only for failure of a new AE Techron product which occurred within the Warranty Period. It does not cover any product which has been damaged because of any intentional misuse, or loss which is covered under any of your insurance contracts. This warranty does not extend to any product on which the serial number has been defaced, altered, or removed. It does not cover damage to loads or any other products or accessories resulting from **AE TECHRON INC.** product failure. It does not cover defects or damage caused by the use of unauthorized modifications, accessories, parts, or service.

WHAT WE WILL DO

We will remedy any defect, regardless of the reason for failure (except as excluded), by repair or replacement, at our sole discretion. Warranty work can only be performed at our authorized service centers or at our factory.

Expenses in remedying the defect will be borne by **AE TECHRON INC.**, including one-way surface freight shipping costs within the United States. (Purchaser must bear the expense of shipping the product between any foreign country and the port of entry in the United States and all taxes, duties, and other customs fees for such foreign shipments.)

HOW TO OBTAIN WARRANTY SERVICE

When you notify us or one of our authorized service centers of your need for warranty service, you will receive an authorization to return the product for service. All components must be shipped in a factory pack or equivalent which, if needed, may be obtained

from us for a nominal charge. We will take corrective actions and return the product to you within three weeks of the date of receipt of the defective product, or will make available to you a product of equal or better performance on temporary loan until your product can be repaired or replaced and returned to you. If the repairs made by us are not satisfactory, notify us immediately.

DISCLAIMER OF CONSEQUENTIAL AND INCIDENTAL DAMAGES

You are not entitled to recover from us any consequential or incidental damages resulting from any defect in our product. This includes any damage to another product or products resulting from such a defect.

WARRANTY ALTERATIONS

No person has the authority to enlarge, amend, or modify this warranty. The warranty is not extended by the length of time for which you are deprived of the use of this product. Repairs and replacement parts provided under the terms of this warranty shall carry only the unexpired portion of this warranty.

DESIGN CHANGES

We reserve the right to change the design of any product from time to time without notice and with no obligation to make corresponding changes in products previously manufactured.

LEGAL REMEDIES OF PURCHASER

There is no warranty that extends beyond the terms hereof. This written warranty is given in lieu of any oral or implied warranties not contained herein. We disclaim all implied warranties, including, without limitation, any warranties of merchantability or fitness for a particular purpose. No action to enforce this Warranty shall be commenced later than ninety (90) days after expiration of the warranty period. This statement of warranty supersedes any others contained in this manual for AE Techron products.

AE TECHRON INC. **Customer Service Department**

2507 Warren St. Elkhart, IN, 46516, U.S.A.
(574) 295-9495
www.aetechron.com

Contents

1	About the 3110A.....	5
1.1	Disclaimer.....	5
2	Getting Started.....	6
2.1	Safety First.....	6
2.2	Stand-alone 3110A Setup.....	6
2.3	Connecting an Amplifier.....	7
2.4	Startup Procedure.....	7
3	Calibration.....	8
3.1	System Calibration	8
3.2	Segment Calibration.....	8
3.3	Calibration for Scripted Variable Loops	11
4	Operation.....	13
4.1	Main Window Controls and Functions.....	13
4.2	Remote Operation.....	14
4.3	Working in Demo Mode.....	16
4.4	USB Drive.....	16
4.5	Updating the 3110A/DSR System.....	17
4.6	Using the 6-to-1 Attenuator.....	18
4.7	Shutdown Procedure.....	19
5	Tutorials.....	20
5.1	3110A Basic Operation Tutorial.....	20
5.2	Working with Waves and Controls Tutorial.....	22
5.3	Running a Test.....	24
5.4	Creating an Exponential Sweep.....	25
6	Waveforms and Controls	27
6.1	Alternating Waves	27
6.2	Ripple Wave	29
6.3	DC Signal	32
6.4	Controls	33
7	Creating Reports and Notes	43
8	Navigating the Files System	45
9	Settings Window	48
10	Troubleshooting	54
11	3110A Calibration	55
11.1	Introduction.....	55
11.2	Documentation.....	55
11.3	Required Instruments.....	55
11.4	Connections and Settings.....	55
11.5	Output Assessments.....	56
12	3110A Capability Map	57
13	Attributions	58
A	3110A Calibration Tests	A68

New in Version 2.2.9

- **New Tests:** Tests from BMW GS95023 and GS95024-2; DO-160G; Ford FMC 1278; ISO 11452-10, 16750-2, and 21498-2; MBN LV 1234, LV123, and LIV148; MIL STD 1275E; Stellantis CS.00244, CS.00245, and CE.00246; Tesla TS-0000425-05 and TS-2024048; VW 80000 and VW 80300; and more. (See the v.txt file for all added tests.)
- **Software Changes:** Update that fixes Pause /Stop/ Run issue.

Bandwidth – DC to 1 MHz

Rise Time – 2 μ s

Cycle Time – 750 μ s*

Minimum Pulse Duration – Under 50 μ s*

*Testing performed using non-swept, fixed-loop segments for at least one minute.

**Testing performed using non-swept segments up to the capacity of the cache (maximum 127 segments).



Figure 1.1 – 3110A Standards Waveform Generator, Front Panel (shown with handles)

1 About the 3110A

The 3110A is a simple-to-use yet powerful standards waveform generator. It has been designed to be used quickly and easily with other AE Techron products to create a wide range of powerful and intelligent EMC test solutions.

The 3110A outputs a standard analog signal that can work with any AE Techron amplifier or other LF amplifiers that you already have. It has a scalable output, so the values entered in the 3110A interface will result in your desired system output. When coupled with AE Techron amplifiers, the 3110A can create virtually all waveforms, DC offsets, drop outs and surges needed for EMC tests with rise/fall times of 2 μ s or greater and frequencies from DC to 1 MHz.

The 3110A software is built around the simple concept of a waveform segment. Each waveform segment can have a unique waveform, (sine, square, triangle, and/or DC offset). Frequency, amplitude and DC offset can be clipped, fixed, variable or swept. Segments can be calibrated (as required in CS101) and set to continue on to the next segment or to hold for an external trigger.

The power of the system occurs when waveform segments are linked to create test sequences. These test sequences can be of any length and can be run as a single sequence, looped segments, or looped segments with multiple variables changing

within the loop (as required in multiple Toyota and GM standards). Finally, multiple test sequences can be combined to create a single customized extended test.

An extensive library of 3000+ tests for many automotive, aviation and industry Standards makes it possible for the 3110A to save time from day one. And, for customers that require over-testing or testing for products that have no predefined standard, tests from the Standards Library can be easily modified and saved for later use.

The 3110A delivers extensive capabilities for LF EMC testing with very short training-time requirements. Plus, it makes it easy to automate repetitive and labor-intensive tasks, making the 3110A a very efficient and cost-effective solution for LF EMC testing.

1.1 Disclaimer

Although AE Techron has made substantial effort to ensure the accuracy of the Standards' test files (SWG files), which are included with the 3110A unit, no warranty, expressed or implied, is made regarding accuracy, adequacy, completeness, legality, reliability or usefulness of the information provided. It is the responsibility of the user to ensure the accuracy and applicability of these test files for their intended purposes.

2 Getting Started

2.1 Safety First

Throughout these instructions, special emphasis is placed on good safety practices. The following graphics are used to highlight certain topics that require extra precaution.

⚠ DANGER

DANGER represents the most severe hazard alert. Extreme bodily harm or death will occur if these guidelines are not followed. Note the explanation of the hazard and instruction for avoiding it.

⚠ WARNING

WARNING alerts you to hazards that could result in severe injury or death. Note the explanation of the hazard and the instructions for avoiding it.

⚠ CAUTION

CAUTION indicates hazards that could result in potential injury or equipment or property damage. Once again, note the explanation of the hazard and the instructions for avoiding it.

2.2 Stand-alone 3110A Setup

The following steps explain how to connect a stand-alone 3110A unit using the cables and accessories provided. Refer to Figure 2.1 for component locations.

NOTE: For **DSR system setup**, including unpacking, installation and power-source connection, please refer to the **DSR Series Operation Manual**.

- A. Plug the USB keyboard into the USB port labeled **KEYBOARD** on the 3110A back panel.
- B. Plug the USB mouse into the USB hub, and then plug the USB hub into the port labeled **MOUSE** on the 3110A back panel.
- C. Plug the HDMI to DVI cable into the HDMI port labeled **MONITOR** on the 3110A back panel, and then connect the cable to the DVI port on the monitor.
- D. Plug the monitor power cord into the monitor, and then connect the cord to a power source.
- E. Plug the 3110A power cord into the power connector located on the 3110A back panel, and then connect the cord to a power source.
- F. **OPTIONAL:** To connect the 3110A to be accessed and controlled through a network: Plug

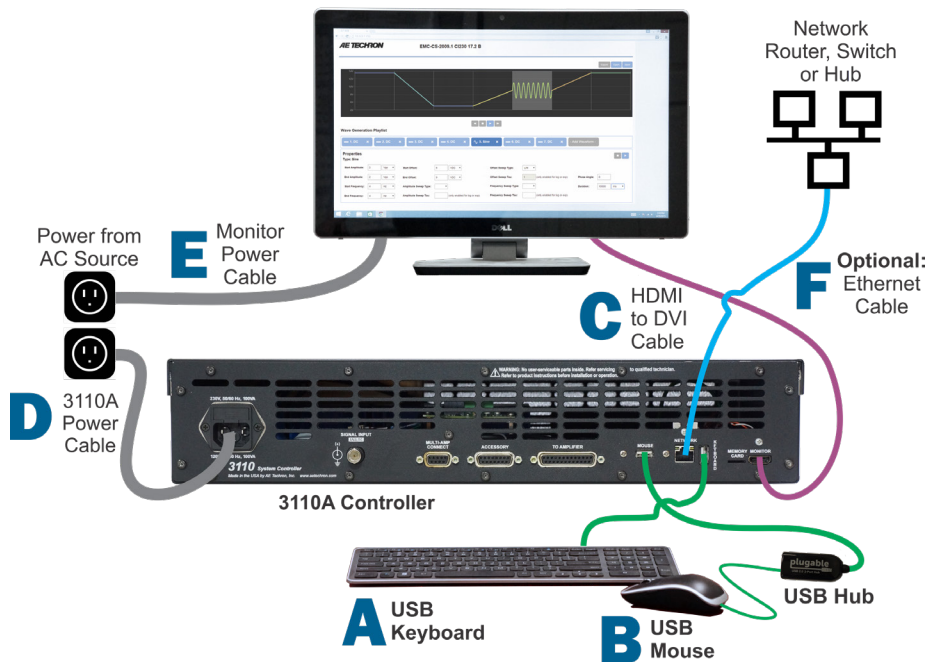

Figure 2.1 – Stand-alone 3110A Setup



Figure 2.2 – Connecting an amplifier to the 3110A

the Ethernet cable to the Ethernet port labeled NETWORK, and then plug the Ethernet cable into a router, switch or hub on the network. See the topic “3110A via Network” for more information.

2.3 Connecting an Amplifier

Complete the following steps to connect and configure an amplifier for use with the 3110A:

1. Complete the steps for “**Stand-alone 3110A Setup.**”
2. Connect from the 3110A’s front-panel Signal Out BNC connector to the signal input connector on your amplifier.

2.4 Startup Procedure

Complete the following steps to power up a 3110A unit and a connected power amplifier.



Figure 2.3 – Monitor on/off switch.

- A. Use the monitor’s power switch (last button on the right) to turn on the monitor.



Figure 2.4 – 3110A on/off switch.

- B. Depress the 3110A POWER switch to turn the 3110A ON.

7212, 7224 and 7226 amplifiers

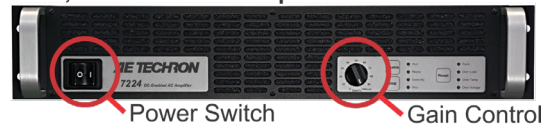

C

7548, 7794 and 7796 amplifiers

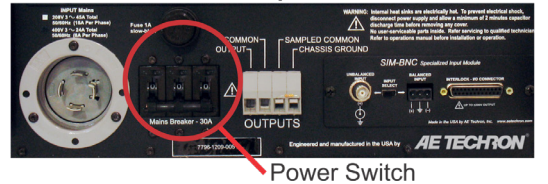

Figure 2.5 – Amplifier gain control and power switch.

- C. If the amplifier has a gain control, turn it fully ON (clockwise). Then turn the POWER switch ON to power up the amplifier.



Figure 2.6 – Electronic Help manual.

- D. Wait for the 3110A’s interface to load (loading will take up to 30 seconds). Press the Help button to access this manual from within the program.
- E. Run the System Calibration test to determine the proper settings for your amplifier. See the “**Calibration**” section for more information.

3 Calibration

IMPORTANT: Before operating the 3110A/DSR system for signal generation with any amplifier, transformer, or other system components, the 3110A System Calibration Test should be run to determine the correct system settings for the 3110A software. Likewise, when any components are added to or removed from the system, the System Calibration Test should be performed again to determine the new system gain.

The 3110A provides three types of calibration testing to help ensure that the output of your system matches the expected output as described in each test segment: system calibration, segment calibration, and calibration of non-linear variable loops.

System Calibration provides accuracy of output for many tests and test conditions. However, some tests may contain high-frequency waveforms or other conditions that will require a gain adjustment at the segment level only. In these situations, segment calibration allows adjustment to gain at the segment level.

Segment Calibration allows adjustments of all individual segments in the sequence. However, when a segment is included in a variable loop, each iteration of the segment will receive the same calibration adjustment.

In some cases, especially when components like transformers are a part of the system, each iteration of a looped segment requires unique adjustments. To provide for those requirements, a separate calibration system for **Scripted Variable Loops** is also available.

3.1 System Calibration

Unlike most ARBs and signal generators, the 3110A Standards Waveform Generator interprets the waveform properties settings as the output desired at the system’s output. These levels are calculated based on the Measured Output and

Measured DC Offset settings entered on the System Calibration tab in the Settings window.

In DSR Series systems, the system calibration settings will be factory set based on the number of amplifiers in the system. For stand-alone 3110A’s, the factory default is set to a System Gain of 20 and a DC Offset of 0, which are typical setting for a 3110A using one AE Techron amplifier.

However, your working configuration can vary greatly from this default configuration; it may contain two or more amplifiers, transformers, an attenuator, or more. Therefore, the factory-default settings must be verified and adjusted to reflect the measured gain and DC offset of your system.

If you are measuring the output of the a stand-alone 3110A (without an amplifier or other components), a System Gain of 1 can be used for 3110A calibration (maximum output will be limited to 10Vp/20Vpp).

3.1.1 System Calibration Procedure

Complete the steps provided on the following page to run the system calibration test and adjust the System Gain and DC Offset settings:

3.2 Segment Calibration

The Segment Calibration function is available in the properties window of any wave segment. Press the Calibration button to bring up the segment calibration dialog. See Figure 3.1.

When the **Run Calibration Test** button is pressed, the 3110A will continuously generate a waveform with characteristics matching the properties defined in the waveform segment. For swept waveforms, a waveform matching the characteristics at the beginning-state of the sweep will be gener-



Figure 3.1 – Segment Calibration Test Window

System Calibration

Complete the following steps to calibrate your 3110/3110A system. System Calibration should be performed when first setting up the system, and any time components are added or removed from the system. Systems using transformers should be calibrated twice: first without the transformer and then after the transformer has been added.

1. Select the Settings button and then open the System Calibration tab.
2. Check the System Gain setting. This should be equal to the approximate gain of the 3110/3110A system (including all amplifiers in the system). A gain of 20 is entered by default. Adjust the gain level to match the anticipated gain of your system. See Figure A.

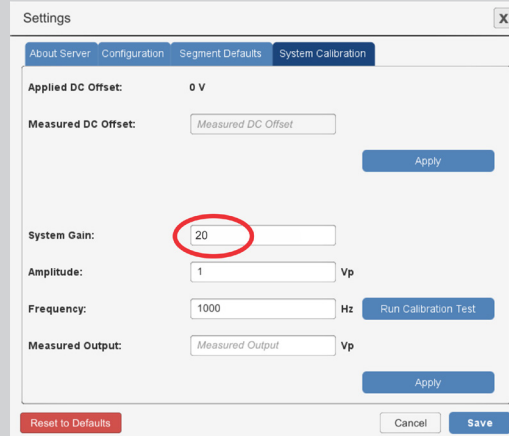

Figure A – Checking the System Gain setting.

3. Measure the DC offset at the output of your system. Enter the output you measured in the Measured DC Offset text box. Then press the Apply button to apply the offset correction. See Figure B.

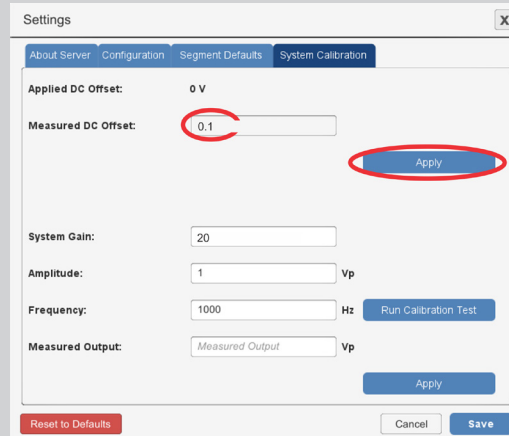

Figure B – Correcting the DC Offset setting.

4. Review the Calibration Test parameters and adjust, if desired. Then press the Run Calibration Test button. See Figure C.

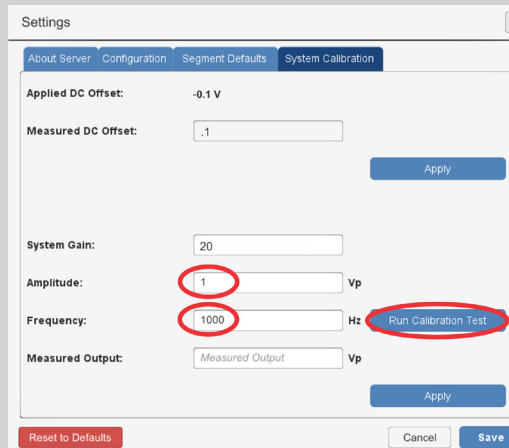

Figure C – Running the Calibration Test.

(continued on next page)

System Calibration (continued)

5. Measure the voltage at your system output, and then enter the measured voltage in the the Measured Output text box. Then press the Apply button to apply the gain correction. See Figure D.
6. You can retest using different test parameters, if desired. Both the Applied DC Offset and the System Gain will incrementally correct the applied levels after the results of each test are entered.
7. Press the Save button to save the system calibration settings and close the Settings window. See Figure E.

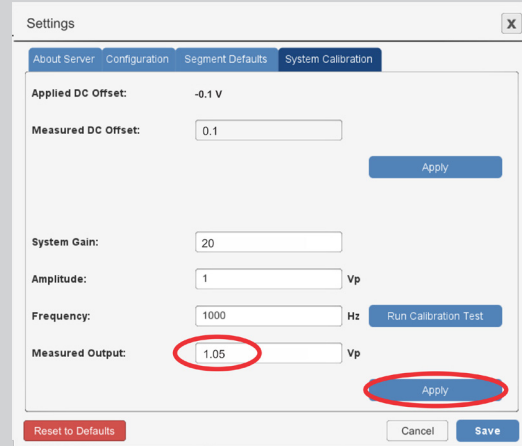

Figure D – Correcting the System Gain setting.

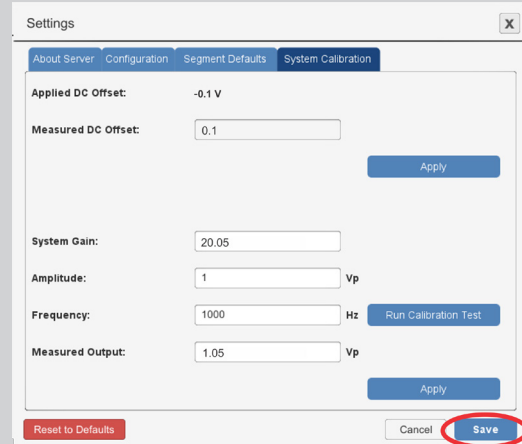

Figure E – Saving the System Calibration Settings

ated.* If the tested output voltage does not match the specified voltage, calculate the amount required to adjust the output voltage by dividing the specified output voltage by the measured output voltage. Enter the results into the Wave Gain input box.

For example, if the tested output is measured at 10.1V, but the specified voltage is 10V, divide 10 by 10.1. Enter the results (0.99) in the Wave Gain

* To validate a segment containing a sweep, we recommend placing one or more temporary wave segments with critical waveform properties defined (such as end-state properties) next to the sweep segment within the test sequence. Calibrate these segments along with the sweep segment to determine what adjustments are required. Then the temporary segments should be deleted before the final test is generated.

input box. Rerun the Segment Calibration test to verify the calibration.

The **Prev** and **Next** buttons can be used to quickly move to the next wave segment in the test sequence for additional calibration testing.

Pressing the **Close** button saves all calibration changes and closes the Segment Calibration window.

NOTE: The calibration test can only produce voltage levels within the voltage limits of the system. If levels above system limits are entered in the **Wave Gain** input box, the calibration test levels will remain at the highest level capable.

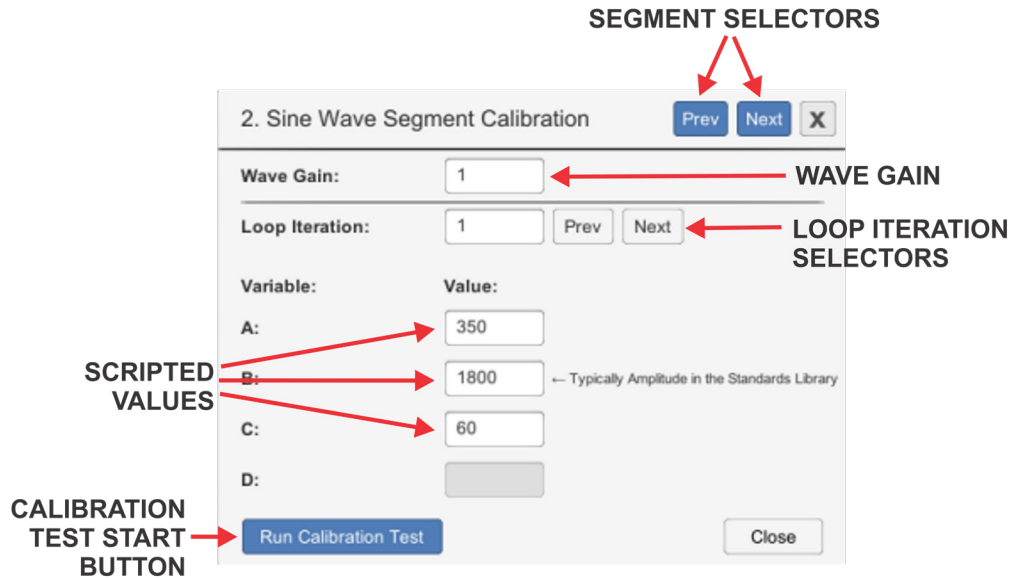

Figure 3.2 – Scripted Variable Loop Calibration Values Window

3.3 Calibration for Scripted Variable Loops

When a waveform segment is part of a scripted variable loop, the Calibration function allows a calibration test to be run for each iteration of the segment in the scripted variable loop.

Note: For instructions on creating a scripted variable loop, see the topic **“Variable Loops”** in the section **“Waveforms and Controls.”**

To perform the calibration, select a waveform segment contained within a scripted variable loop. Then press the Calibration button to open the Cali-

bration Values window. See **Figure 3.2.**

The values for all scripted variables in the first iteration of the segment within the variable loop will be shown in the Calibration Values window. Determine the variable that defines the amplitude of the segment (all scripted variable loops in the Standards Library use the variable “B” for amplitude levels). Note: Scripted variable loops using user-created CSV files are not supported by AE Techron.

Press the Run Calibration Test button to begin the

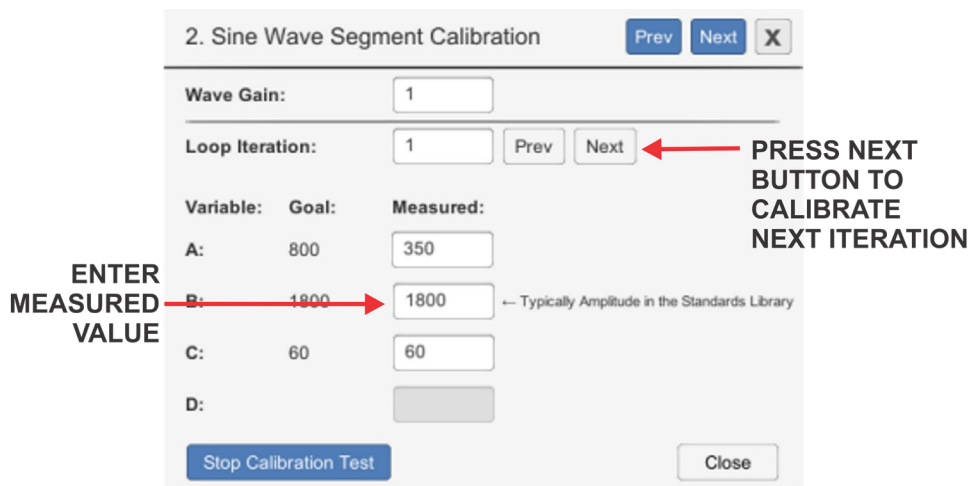

Figure 3.3 – Scripted Variable Loop Calibration Test Window

calibration testing. The Calibration Test window will open showing Goal and Measured values for each variable. See **Figure 3.3**. Note the value shown as the Goal for the variable that defines amplitude, and then note the actual level that is measured at the DUT. Type the measured value in the Measured column for the variable being tested, and then press Enter or click outside of the input box to enter the new value.

The SWG software will automatically calculate difference between the Goal and Measured values and increase or decrease the value of the amplitude for that iteration to create the desired value at the output. Check the new output being measured at the DUT. This should now closely match the Goal value from the scripted variable loop. If the value does not match within your tolerances, enter the new measured value in the measured column of the Calibration Test window. Repeat this step as many times as necessary to create the exact output desired.

Then press the white Next button to move to the next iteration in the loop.* Continue measuring and entering measured values for each of the iterations in the loop. When calibration testing is completed, press the Stop Calibration Test button. The calibration test will stop and you will be returned to the initial Calibration Test window. Note that the new amplitude values that have been calculated by the SWG software will be shown in the Value column.

Press the Close button to close the Calibration

window. Or, if you prefer, press the blue Next button to go to the next segment in your test sequence to continuing calibrating.

3.3.1 Wave Gain Other Than One

The value for Wave Gain shown in the Calibration windows will typically equal 1, and this value should not be changed. However, a wave segment move into a scripted variable loop from outside the loop may have been previously calibrated using the Segment Calibration method. In this case, the calibration value will be retained for the user's reference, but should be changed to a value of 1 before calibration testing using the Scripted Variable Loop calibration method.

3.3.2 Saving Calibrated Values

All new calculated values for the variable loop will be saved with the SWG file and can be reused. If a scripted variable loop will be used with different setups (for example, with different transformers), simply save the SWG file in the User Standards directory to maintain multiple versions of the calibrated scripted variable loop.

Note that saving the calculated values may save time when calibration is performed at a later date, but AE Techron always recommends performing appropriate calibration before running any test sequence.

4 Operation

IMPORTANT: Before operating the 3110A with an amplifier connected, the **3110A System Calibration Procedures** should be performed to determine the correct System Gain and DC Offset settings for your system. See the topic **“System Calibration”** in the **“Calibration”** section for more information.

For help in getting up and running quickly on the 3110A, please see the **“Tutorials”** section in this Help Manual.

4.1 Main Window Controls and Functions

Refer to **Figure 4.1** for information about the controls and functions available in the main window of the 3110A’s interface.

A. **Demo Mode message/Network Mode switch** (Windows’ Remote Client software only): This message will appear in the main window when the 3110A’s Windows’ Remote Client software is operating in Demo Mode. To switch to remote operation of the 3110A via network,

click on the Demo Mode message to open the network connection window. See the topics **“Working in Demo Mode”** and **“Remote Operation”** later in this section for more information.

- B. **Test Sequence Display:** Wave and control segments added to the test sequence are visually displayed in this area. Wave segments will be represented with a waveform approximating the signal described by the wave segment properties. Control segments will be represented with colored segment blocks. Select Save As from the Files window to save the sequence as an .swg file.
- C. **Files button:** Press this button to open the 3110A’s file system. From the file system, you can access the 3110A’s Standards Library and User Standards directory. Access to a connected network and USB drive (when mounted) also are available through the file system dialog. See the section **“Navigating the File System”** for more information.
- D. **Report/Notes button:** Press this button to open the Report/Notes window. The Report/

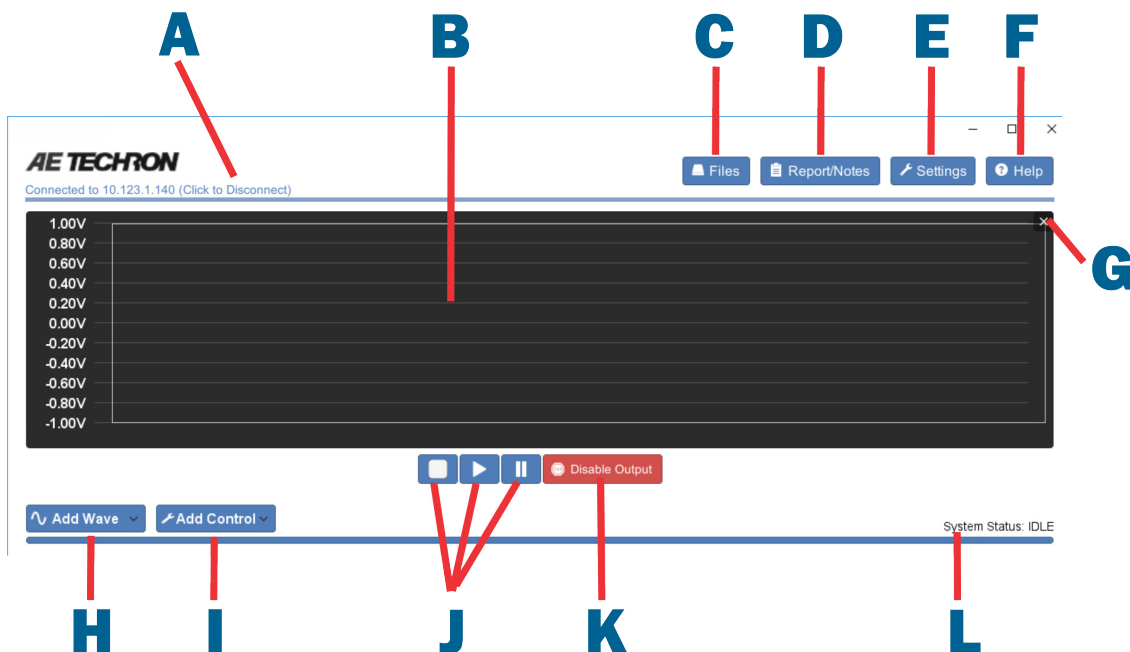

Figure 4.1 – Main window controls and functions

Notes window allows you to enter custom information and notes and to generate a report from the open test sequence. See the section **“Creating Reports and Notes”** for more information.

- E. **Settings button:** Press this button to open the Settings window. The Settings window provides access for system and wave segment configurations, program version information and IP network setting, and access to the System Calibration test. See the section **“Settings Window”** for more information.
- F. **Help button:** Press this button to access the **3110A Help Files** manual through the 3110A system.
- G. **Clear Test Sequence Display:** Press the X to clear all wave and control segments from the test sequence display. Note that any changes that have not been saved to an .swg file will be lost.
- H. **Add Wave button:** Press this button to select a wave type and add a wave to the open test sequence. See the section **“Waves and Controls”** for more information.
- I. **Add Control button:** Press this button to select a control type and add a control to the open test sequence. See the section **“Waves and Controls”** for more information.
- J. **Stop/Run/Pause buttons** (not available in Demo Mode): Press the Run (arrow) button to send the open test sequence to the 3110A and begin generating output signal. Press the Pause (double lines) button to pause signal generation. Press the Stop (square) button to stop signal generation and reset the test to the beginning of the test sequence. See the tutorial **“Running a Test”** for more information.
- K. **Output Enabled/Disabled button** (not available in Demo Mode): Press this button to disable signal output when running a test sequence. Press the button again to enable signal output. See the tutorial **“Running a Test”** for more information.
- L. **System Status message:** The System Status message will display the state of the 3110A as

“Idle” whenever a test sequence is not running. The status will also be shown as “Idle” at all times when operating in Demo Mode. When the Run button is pressed, the System Status message will display a running count of the time elapsed in the test. Alternately, if the “Total Duration” option is selected on the Configuration tab in the Settings window, the System Status message will display a running count-down of the time remaining in the test. In addition, the Status Message will display a running count of the test segments as the sequence is being run (i.e, “1 OF X” where “X” is the total number of wave segments and controls included in the test sequence). When the Pause button is pressed, the System Status message will show as “Paused.”

4.2 Remote Operation

The 3110A/DSR System comes with an installation copy of Windows’ Remote Client software on the supplied USB drive (shipped with the 3110A/DSR System). The Windows’ Remote Client software allows the 3110A interface to be controlled from a remote computer via an Ethernet network. It can also be used on a Windows’ computer (without being connected to the 3110A) to edit or create test sequences while the 3110A/DSR System is being used elsewhere.

Windows’ Remote Client Software

Minimum Installation Requirements:

64-bit Operating System: WIN 7, 8 or 10
 Hard disk space: 100MB
 4GB RAM

Recommended:

8GB RAM
 Dedicated 1GB graphics card

4.2.1 Controlling the 3110A or DSR System Through a Network

To access and control the 3110A or DSR System-through your local network, complete the steps below:

1. Locate the port labeled Network on the back panel of the 3110A or DSR system. Connect an Ethernet cable between the 3110A or DSR

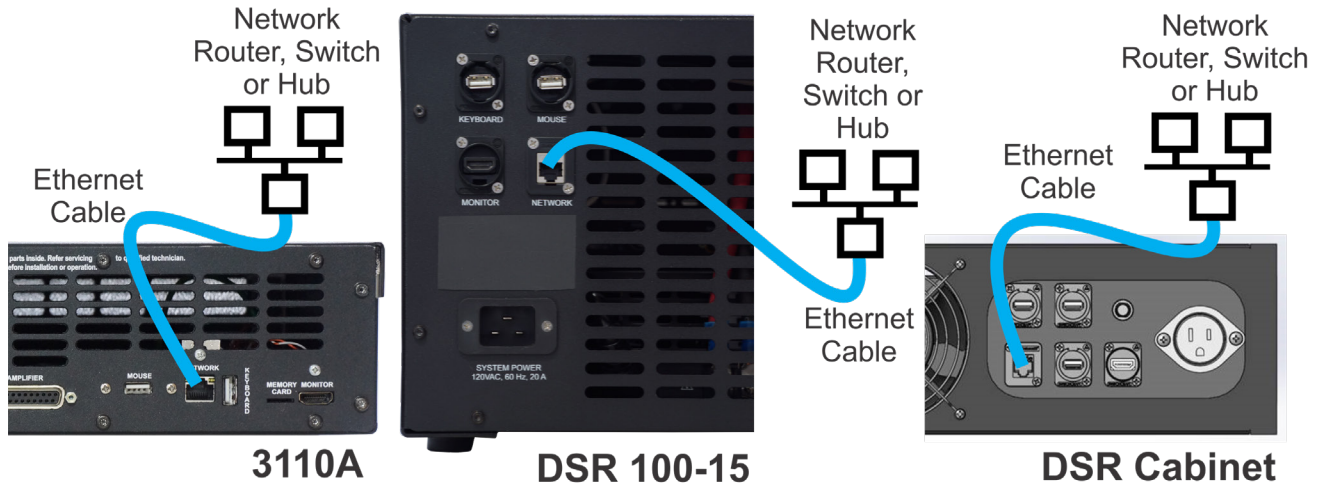

Figure 4.2 – Connecting the 3110A or DSR system to an Ethernet network

- system and your network hub, router or switch, as shown in **Figure 4.2**.
- Switch on the DSR system or 3110A and amplifier, and wait for the 3110A's interface to load (this can take up to 30 seconds). Press the Settings button to open the Settings window, and then select the **About Server** tab. Note the IP address shown in the IP Address section, and write it down for later reference. See **Figure 4.3**. Press the Cancel button to close the Settings window. **NOTE:** If the Service Endpoint box is blank or contains the IP address 0.0.0.0, then the 3110A/DSR system is not connected to your network. Check your Ethernet connection or contact your network administrator for assistance.

- Insert the USB drive (included with the 3110A/DSR system) into an open USB port on the computer to be used for accessing the 3110A/DSR system across the network. Open the USB drive and then locate and install and the Windows' Remote Client installation file named **Setup.exe**.
- When the program has been installed and loaded, the notice *"Not Connected to 3110A - Running in Demo Mode (Click to Connect)"* will be displayed in the upper left of the window (see **Figure 4.4**). Click the message to open the connection dialog, and then type the 3110A IP address you wrote down into the IP Address text box. Press OK to connect to the remote 3110A/DSR system. The remote 3110A's dis-

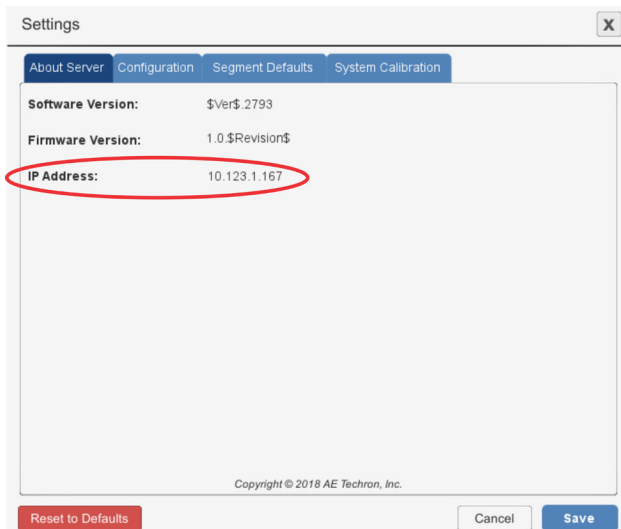

Figure 4.3 – 3110A IP Address Listing

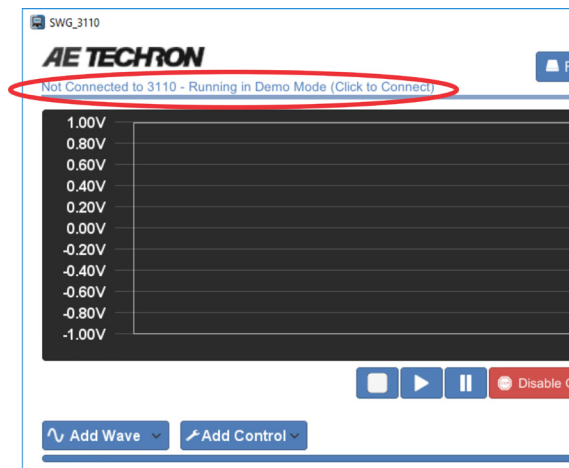

Figure 4.4 – Remote Connection to the 3110A/DSR System

play will be shown on your computer monitor, and the 3110A can now be controlled remotely.

Removing I/O Devices

If the 3110A/DSR system will only be operated remotely through your network, the I/O devices (monitor, mouse and keyboard) can be removed. Leave the DSR system or 3110A and amplifier powered on for continued use through the network.

Reconnecting to the 3110A Remotely

If the 3110A/DSR system is disconnected from the network, it may be assigned a new IP address when the unit is reconnected to the network. To find the new IP, go to the 3110A (reconnect monitor and mouse, if necessary), and then press the Settings button to open the Settings window. Select the About Server tab and review the IP address listing. Enter the new IP address in the IP Address text box on the remote computer.

4.3 Working in Demo Mode

A Windows computer (WIN 7, 8 or 10) can be used to create .swg test files for later use by working in Demo Mode using the Windows Remote Client software.

When working in Demo Mode, the Windows computer does not need to be in contact with the 3110A via network connection, so the 3110A can be used to run existing test routines while new routines are created elsewhere.

To prepare a computer to run in Demo Mode, install the Windows' Remote Client software (Setup.exe), which is provided on the USB drive that was included with the 3110A/DSR system.

Once the program has installed and loaded, the notice *“Not Connected to 3110A - Running in Demo Mode (Click to Connect)”* will be displayed in the upper left of the main window (see **Figure 3.4**).

A local copy of the 3110A Standards Library is saved to the Windows computer when the Remote

Client software is installed, so you can load tests from the Standards Library to use as a template to edit and save as a new test file. You can use the **Add Wave** and **Add Control** buttons to create new test sequences.

When the test sequence is complete, press the Files button to save the .swg file in the User Standards directory on your Windows computer. When working in Demo Mode, files saved to the User Standards directory will be saved on your local hard drive in your Documents directory in a sub-directory named “Demo SWG.”

To transfer the files saved on your local drive to the 3110A/DSR system, use the provided USB drive to copy the .swg files from your hard drive to the USB drive. Then insert the USB drive into the USB hub installed in the USB port labeled “Mouse” on the back of the 3110A/DSR system. See the following topic **“USB Drive”** for more information.

Start the 3110A (if needed) and use the Files button to open the files manager, and then open the USB drive. Copy the files located on the USB drive, and then paste the files into the User Standards directory on the 3110A.

NOTE: The files can be retrieved from the USB drive using the 3110A/DSR system locally and can also be transferred using a remote computer connected to the 3110A/DSR system via network. For more information, see the topic **“Remote Operation”** earlier in this section.

4.4 USB Drive

The 3110A/DSR system ships with a USB drive and a 2-port USB Hub (see **Figure 4.5**). The 2-port



Figure 4.5 – Two-port USB Hub

USB Hub should be plugged into the USB port labeled “MOUSE” on the back panel of the 3110A/DSR system, and the supplied USB Mouse should be plugged into one port on the USB Hub. The second port on the USB Hub can be used for the supplied USB drive. **IMPORTANT:** The 2-port USB Hub can only be used in the USB port labeled “Mouse.”

The USB drive contains the Windows’ Remote Client software Setup.exe file that can be used to install the remote access program on a Windows’ computer. For more information, see the topic “**Remote Operation.**”

The USB directory will be visible at the top level of the Files window when working directly on the 3110A or when accessing the 3110A remotely. However, the USB directory will not appear when working in Demo Mode. The USB directory can only be opened when the USB drive has been inserted into the open USB port on the USB Hub attached to the 3110A/DSR system.

To safely remove a USB drive from the USB port, first select the Unmount USB button in the Files window, and then remove the drive from the USB hub. Note: If the Unmount USB button is not pressed before removing the USB drive, the 3110A/DSR system may not recognize the USB drive when it is returned to the USB port. If the USB drive is not recognized, press the Unmount USB button and then remove the USB drive from the USB port. Then return the USB drive to the USB port to gain access to the USB drive.

The USB drive also can be used to create a backup of the .swg files stored in the 3110A/DSR system and to move .swg files created on a Windows computer running in Demo Mode to the 3110A/DSR system for use. See the topic “**Working in Demo Mode**” earlier in this section.

In addition, the USB drive can be used to update the 3110A/DSR system. See the following topic “**Updating the 3110A**” for more information.

4.5 Updating the 3110A/DSR System

Updates for the 3110A software (including additions to the Standards Library) and the Windows’ Remote Client software are available through **AE Techron Technical Support** or your AE Techron Sales Partner. **NOTE:** When updating the 3110A software, all Windows computers used to access the 3110A remotely must also be updated with the corresponding version of the Windows’ Remote Client software.

Complete the following steps to update the software and load additional tests into the Standard’s Library on the 3110A/DSR system:

1. Obtain the update package (.apk file) for updating the 3110A software from AE Techron or an AE Techron Sales Partner. Save the file on the USB drive that came with your 3110A/DSR system.
2. Insert the USB drive into the open port on the USB hub that has been inserted into the USB port on 3110A/DSR system back panel labeled “Mouse.”
3. Turn on the 3110A/DSR system and allow the software interface to load. Then locate and press the Files button to open the Files explorer. Open the USB directory and then locate the update .apk file you saved.
4. Select and open the .apk file. You will be prompted to approve new permissions (if any). If no new permissions are required, select the INSTALL button at the bottom right of the screen to start the update process (see **Figure 4.6**).
5. The message “App installed” will appear in the window when the update has been successfully performed. Select the “Done” button to close the dialog box and return to the normal 3110A interface.
6. Check the version information displayed on the About Server tab in the Settings window to confirm the update has been successfully installed.

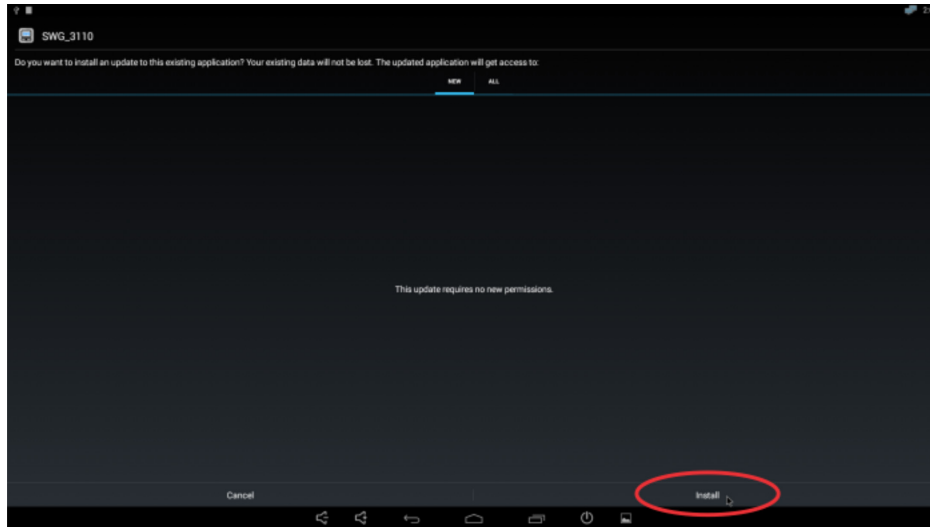

Figure 4.6 – Updating the 3110A/DSR System

4.5.1 Updating the Windows’ Remote Client Software

Complete the following steps to update the Windows’ Remote Client software on a Windows computer (Windows 7, 8 and 10):

1. Obtain the update program (.exe file) for updating the Windows remote client from AE Techron or your AE Techron Sales Partner. Save the file on a USB drive, on your local computer, or on a network drive that is accessible to the computer(s) being updated.
2. Locate and open the downloaded .exe file via Windows File Explorer. You will be prompted to approve the update process. Once approved, the update process will begin.
3. A dialog box will confirm the update has been successfully performed. Close the dialog and the 3110A Remote Client will automatically load.
4. Check the version information displayed on the About Server tab in the Settings window to confirm the update has been successfully installed.

4.6 Using the 6-to-1 Attenuator

NOTE: A 6:1 attenuator is built into DSR Series systems. See the *DSR Series Operation Manual*

for information on using the DSR system’s built-in attenuator.

A BNC male-to-female fixed attenuator is included in the accessories shipped with 3110A stand-alone units. This attenuator has a drop of 6:1, or 6 volts in, 1 volt out.

Most test sequences do not require the use of this attenuator. However, tests having a maximum voltage of less than 30V may require the use of the attenuator.

The purpose of the attenuator is to DECREASE the overall system gain of the 3110A + amplifier from the typical setting of 20 to a setting that is 20/6 or approximately 3.33. Lowering the system gain allows the user to achieve maximum system signal-to-noise performance.

In general, if you are experiencing noise during testing, use of the attenuator is recommended.

4.6.1 Installing the Attenuator

Connect the attenuator’s BNC male end to the Signal Out BNC female connector on the front of the 3110A.

Connect a BNC cable to the female end of the attenuator, and then connect the cable to the unbalanced BNC input on the amplifier.

If using, connect a transformer to the amplifier outputs.

4.6.2 System Calibration

When the attenuator is used, System Gain must be recalibrated. This allows the 3110A to adjust its output levels to deliver the required levels at the system output.

To adjust the 3110A's System Gain setting complete the following steps:

1. Press the Settings button from the 3110A's main window, and then select the System Calibration tab.
2. If desired, adjust the 3110A Output Voltage from the default setting of 1 Vp.
3. Connect an oscilloscope to the DUT (load at the system output).
4. Press the Run Calibration Test button to run the Calibration Test.
5. When the System Calibration testing is completed, press the Save button to save the new System Gain setting and return to the 3110A's main menu.

4.7 Shutdown Procedure

IMPORTANT: Any powered amplifiers that are connected to the 3110A must first be disabled before shutting down the 3110A or DSR System. Failure to follow the proper shutdown procedure

can result in damage to the amplifiers or any connected load/DUT.

Complete the following to safely shut down a 3110A/amplifier combination or DSR System:

1. Make sure all amplifiers connected to the system are disabled. To quickly disable AE Techron amplifiers, press the Stop button on the front panel of any amplifier to place all connected units in Standby mode. Or, you can turn the amplifier(s) OFF using the amplifier's power switch or breaker. Consult the amplifier or ***DSR Series Operation Manual*** for amplifier power switch location. For non-AE Techron amplifiers, consult the product instructions to determine the best method for disabling those units.
2. **DSR Systems:** After all amplifiers have been disabled, turn the system OFF by pressing the System Power button. **Stand-alone 3110As with attached amplifiers:** Place the 3110A's front-panel power switch in the OFF (O) position. Then use the amplifier's power/breaker switch to turn off each amplifier in the system.
3. **Stand-alone 3110As** that do not have any amplifiers or load attached can be safely shut down by simply pressing the 3110A front-panel power switch.

5 Tutorials

The following tutorials provide instruction for basic use of the 3110A software, such as adding waveforms and controls, running a test (completed

waveform sequence) and creating the more complex exponential sweep waveform. Complete the steps in each tutorial to learn about these operations.

5.1 3110A Basic Operation Tutorial

1. Select the Settings button and then open the **System Calibration** tab to set the 3110A system gain and DC offset. The default gain setting is 20, but this should be calibrated to match your actual system gain. When measuring 3110A output directly (without amplification), the system gain can be set to 1 for a maximum of 10Vp/20Vpp output. See the topic **“System Calibration”** in the **“Calibration”** section for more information.

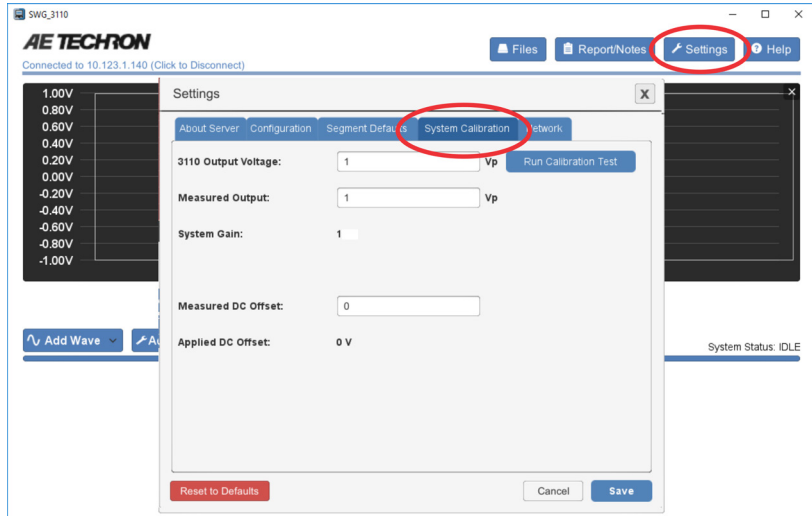

Figure 5.1 – System Calibration tab.

2. Use the Files button to load a test from the Standards library.

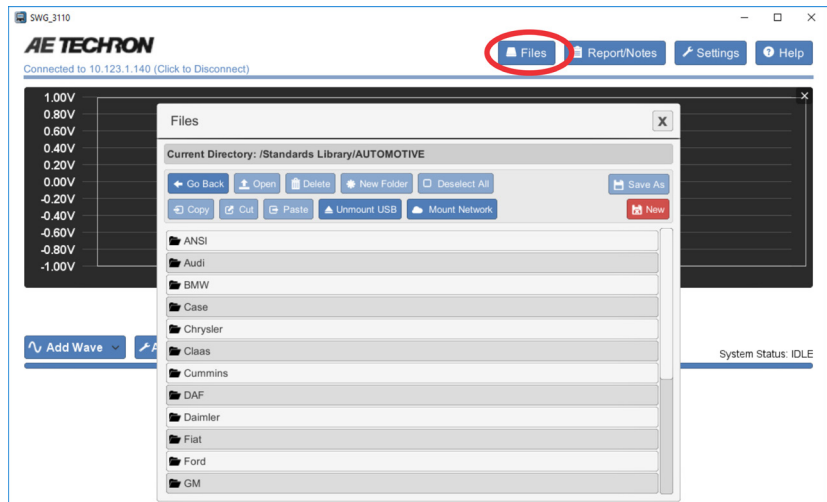

Figure 5.2 – 3110A Standards Library.

3. Use the Add Wave and Add Control buttons to select a waveform or control to add to the test window.



Figure 5.3 – Wave and Control menus.

- Select the tab for a waveform or control to open the Properties dialog. Edit the properties to create complex waveforms and waveform sequences.

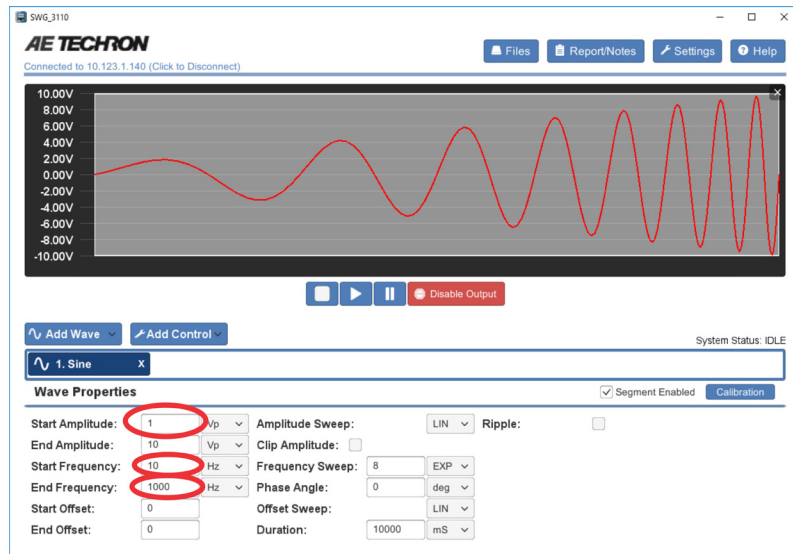

Figure 5.4 – Wave Properties window.

- Segments can be dragged to change their order. To remove a segment from the test, press the X on the segment's tab.

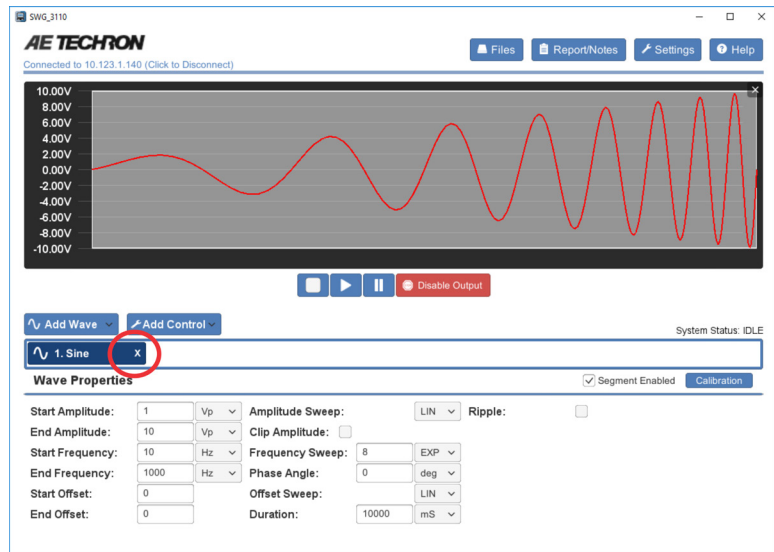

Figure 5.5 – Deleting a segment.

- When your test sequence is complete, press the Arrow button to begin generating signal output from the amplifier.



Figure 5.6 – Generating output signal

5.2 Working with Waves and Controls Tutorial

The following tutorial provides basic instructions for creating, customizing, and using waveform segments.

1. The **Add Wave** button opens a drop-down menu listing the types of waveforms that can be added to the test sequence. You can choose Sine, Ripple, DC, Triangle, Square or Sawtooth waveforms. The **Add Control** button opens a drop-down menu listing the types of controls that can be added. You can choose Trigger, Fixed Loop, Variable Loop, Template, GPIO Output* or LAN Output. Choose the Sine waveform from the Add Wave drop-down menu. A sinewave with the program's default settings will be added to the display.

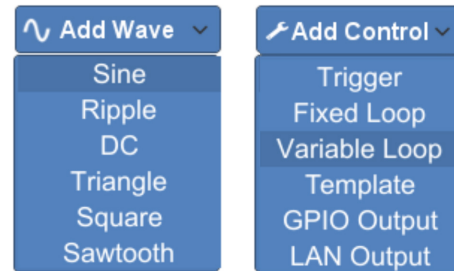

Figure 5.7 – Add Wave and Add Control menus

2. Click on the tab (or the waveform in the display) to open the Properties window containing the available property settings for that waveform. (See the section “Waveforms and Controls” in this Help manual for more information about the settings available for each waveform type.)



Figure 5.8 – Opening the Properties window.

3. Make the following changes to the Property settings: Change the Start Amplitude value to 1 Vp and the Start Frequency value to 100 Hz. Notice that as you adjust settings for the waveform in the Properties window, the visual depiction in the display will adjust to reflect the approximate signal being described by the waveform properties. **Note that durations are NOT shown to scale.**

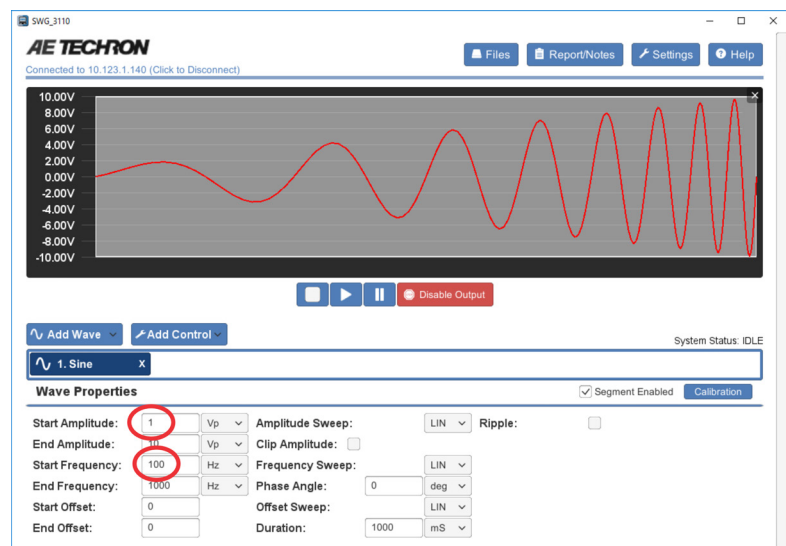

Figure 5.9 – Changing values in the Properties window..

*GPIO output control is not supported on DSR Series systems.

- Click on the value field for Start Amplitude property. A hint window will appear above the field displaying the minimum and maximum allowable values for that property. Enter a value outside of that range (for example, 500 Vp). The entry field will change to red and the allowable range will be displayed within the field. Enter the value 1 Vp (or another allowable value) to remove the error.

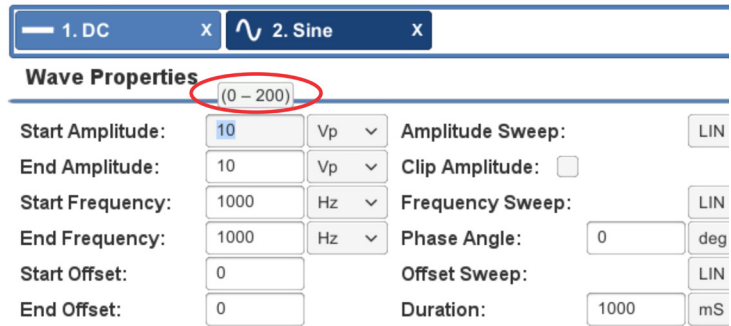

Figure 5.10 – Viewing the allowable range for a waveform property.

- Add additional waveforms to the test by selecting additional waveforms from the drop-down menu. New waveforms will be inserted to the right of the selected control or waveform.



Figure 5.11 – Adding additional waveform segments to the test sequence.

- To reposition a waveform within the test sequence, click on the waveform in the display window and then drag the waveform to the desired position in the sequence.

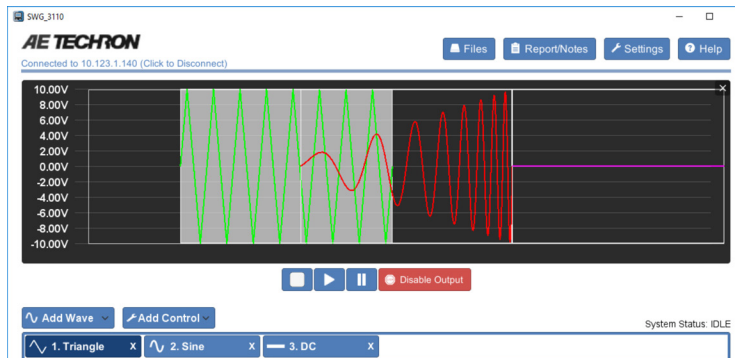

Figure 5.12 – Repositioning waveform segments in the test sequence.

- To remove a segment from the test, press the "X" on the segment's tab.

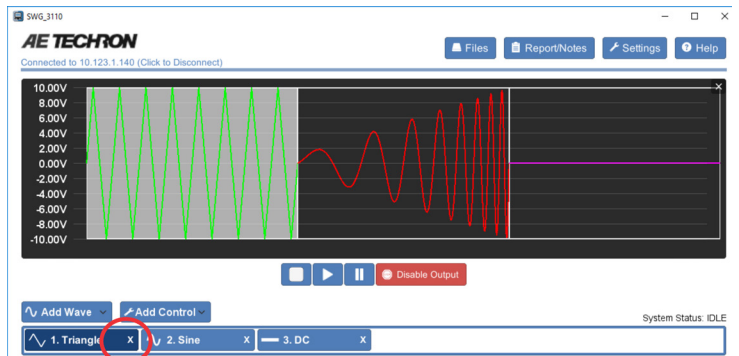

Figure 5.13 – Removing a waveform segment

5.3 Running a Test

One or more waveforms and/or controls that have been added to the active test window can be run using the controls located below the display window. See **Figure 5.14**.

1. If using the stand-alone 3110A, connect the 3110A and amplifier following the instructions in the section “**Getting Started.**”
2. Attach an oscilloscope to the Test Supply or amplifier Output connectors to monitor the signal being generated.
3. In the 3110A software interface, use the **Add Wave** button to add one or more waveforms to the test window.
4. Press the **Run** button. When the **Run** button is pressed, the system will begin generating signal starting at the beginning of the test sequence (the waveform or control farthest to the left). The System Status reporting message will change from “Idle” to “1 of X,” with X being the total combined number of waveforms and controls in the test.
5. Notice that individual segments may be highlighted in the display window during playback. This occurs when the 3110A/DSR system is currently generating the highlighted segment and the segment is equal to or greater than one second in duration. Segments shorter than one second are too short to register as being highlighted.
6. Press the **Pause** button. The system will stop generating the signal described in the test sequences. By default, the controller will generate no signal while a test is paused. To generate a predetermined DC signal instead, change the Pause Voltage setting on the Configuration tab in the Settings window. See **Figure 5.15**.
7. Press the **Run** button. The system will begin generating signal starting at the beginning of the last active waveform segment. The System Status reporting message will continue the count of the number of segments run in the test.

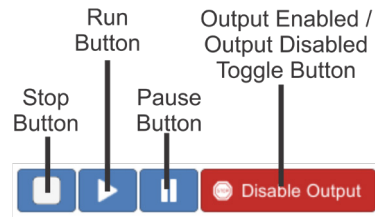

Figure 5.14 – Test Playback and Output Controls

8. Press the **Stop** button. When the **Stop** button is pressed, the 3110A will stop signal generation, and the test will reset to the start of the first waveform. The system will report its status as “Idle.” The system will report its status as Idle at all times that the 3110A is operating normally but a test is not actively running.
9. Restart the test by pushing the **Run** button, and then push the red **Output Enabled** button. The button will change to green and will be labeled “**Output Disabled.**” Notice that the test continues to progress in the 3110A display, but that signal output has been muted.
10. Press the green **Output Disabled** button. The button will toggle back to the red “**Output Enabled**” button and signal generation will resume. Note that running a test with output disabled can be useful for testing a sequence before generating output.

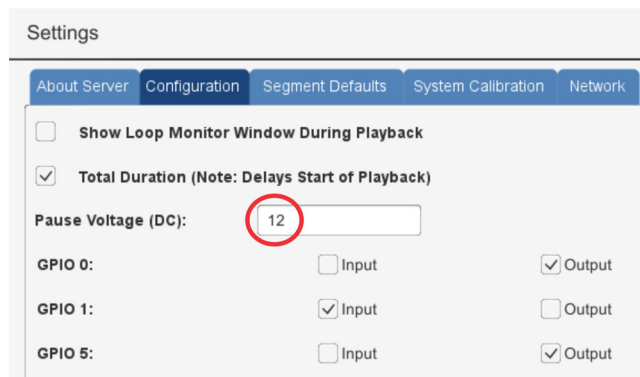

Figure 5.15 – Setting the Pause Voltage (DC)

5.4 Creating an Exponential Sweep

An exponential sweep can be used to create voltage dips, surges and other similar waveforms. When an exponential sweep is selected in the wave properties window, an effective time constant property is available and can be used to control the shape of the swept waveform.

The following tutorial demonstrates the use of the effective time constant to control an exponential sweep.

1. Connect an oscilloscope to the Output connectors of the 3110A. or the Test Supply connectors on a DSR system.
2. Add four DC wave segments to the 3110A test window.
3. Set the first segment's properties as follows: Start Offset, 0; End Offset, 10; Offset Sweep, 8, EXP; Duration, 1000 ms. See **Figure 5.16**.
4. Set the second segment's properties as follows: Start Offset, 0; End Offset, 10; Offset Sweep, -8, EXP; Duration, 1000 ms.
5. Set the third segment's properties as follows: Start Offset, 10; End Offset, 0; Offset Sweep, 8, EXP; Duration, 1000 ms.
6. Set the third segment's properties as follows: Start Offset, 10; End Offset, 0; Offset Sweep, -8, EXP; Duration, 1000 ms.
7. Run the test sequence. The resulting output should be similar to that shown in **Figure 5.17**. Note that a rising exponential will be concave when a positive value is used for the effective time constant property, but convex when a negative value is used. Conversely, a falling exponential will be convex when a positive value is used for the effective time constant property, but concave when a negative value is used.
8. Next, edit the four DC segments to create four exponential sweeps from 0 VDC to 10 VDC. Set the effective time constant property of the first segment to -2, the second to -5, the third to -7 and the fourth to -8.

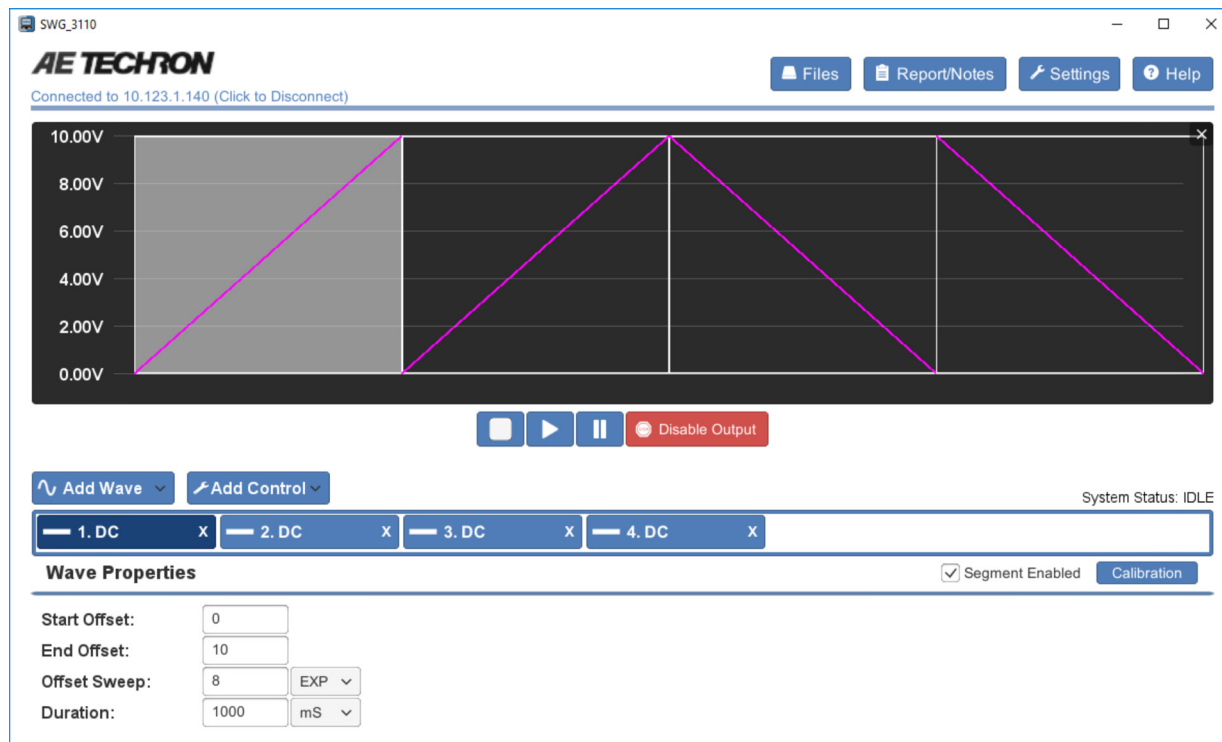

Figure 5.16 – Properties of DC Waveform with Exponential Sweep

Exponential Sweep Comparison

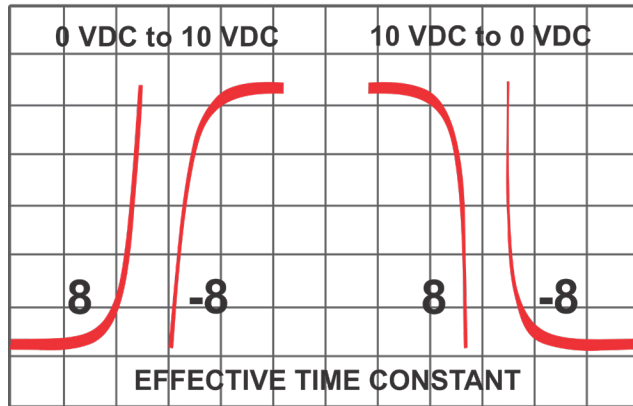

Figure 5.17 – Comparison of Effective Time Constant Sign Settings

**Exponential Sweep
0 VDC to 10 VDC**

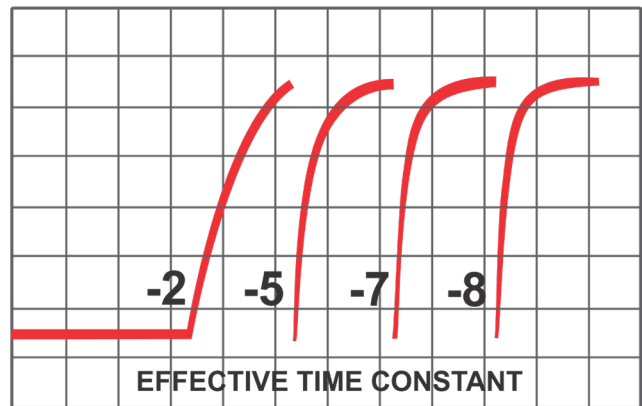

Figure 5.18 – Comparison of Effective Time Constant Value Settings

- Run the test sequence. The resulting output should be similar to that shown in **Figure 5.18**. Note that higher values for the effective time constant property will result in a steeper slope on the exponential.

6 Waveforms and Controls

The **Add Wave** and **Add Control** buttons are located below the display panel in the 3110A software’s main window. Use these buttons to add waveform and control segments to the test sequence to create the complete sequence for your test.

After a waveform or control is added to the test sequence, click on the tab (or the wave or control icon in the display) to open the Properties window and adjust the properties to meet your requirements.

6.1 Alternating Waves

6.1.1 Alternating Wave Types

Alternating waveform types include Sine, Triangle, Square and Sawtooth. Alternating waveform types accept the same property settings, but the capabilities will differ between waveform types.

Sine Wave: The 3110A uses its arbitrary waveform generator to create the specified sine wave output. Select Sine from the **Add Wave** drop-down when you need to create an audio-frequency sinusoidal waveform (DC to 15 kHz).

Triangle Wave: The 3110A uses its arbitrary waveform generator to create the specified triangle wave output. Select Triangle from the **Add Wave** drop-down when you need to create an audio-frequency triangle waveform (DC to 15 kHz).

Square Wave: The 3110A uses its arbitrary waveform generator to create the specified square wave output. Select Square from the **Add Wave** drop-down when you need to create an audio-frequency square waveform (DC to 15 kHz).

Sawtooth Wave: The 3110A uses its arbitrary waveform generator to create the specified sawtooth wave output. Select Sawtooth from the **Add Wave** drop-down when you need to create an audio-frequency sawtooth waveform (DC to 15 kHz).

6.1.2 Alternating Wave Properties

Set the alternating waveform properties to specify the characteristics of the wave to be produced at the amplifier output. See **Figure 6.1**.

Amplitude: The Start Amplitude and End Amplitude properties determine the height of the wave from the zero-crossing point to the crest, measured in volts. Amplitude can be defined using the units Volts peak (Vp), Volts peak-to-peak (Vpp) or Volts root-mean-square (Vrms). When the unit of measure is changed, the 3110A automatically converts the property’s value to the new unit of measure. The units of measure used for Start Amplitude and End Amplitude do not need to be the same.

The values for both Start and End Amplitude can be positive or negative, and the allowable range for these values will be determined by the 3110A based on the System Calibration settings (for more

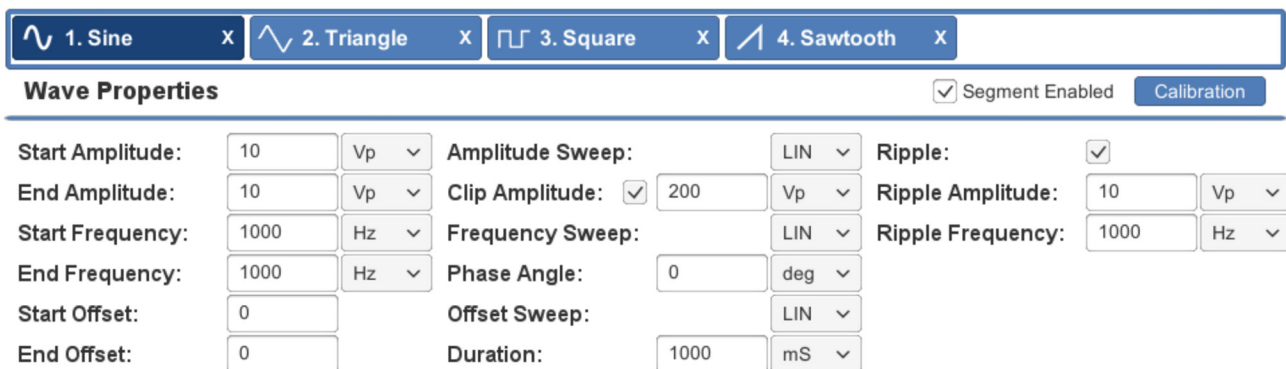

Figure 6.1– Alternating Waveform Properties (all wave types except Ripple and DC)

information, see the topic “**System Calibration**” in the “**Calibration**” section). The default allowable range is $\pm 200\text{Vp}$ (with system gain set to 20). This range is displayed above the selected input box. When a value outside of the allowable range is entered, the input box will turn red.

Frequency: The Start Frequency and End Frequency properties determine the frequency of the wave in cycles per second (Hertz). Frequency can be defined using Hertz (Hz) or Kilohertz (kHz) as the unit of measure. When the unit of measure is changed, the 3110A automatically converts the property’s value to the new unit of measure. The units of measure used for Start Frequency and End Frequency do not need to be the same.

The allowable minimum value for Start Frequency is 0.1 Hz. The allowable maximum value for End Frequency is 15 kHz. This range is displayed above the selected input box. When a value outside of the allowable range is entered, the input box will turn red.

DC Offset: The Start Offset and End Offset properties supply a constant positive or negative DC voltage on the AC wave. DC Offset is defined in Volts DC (VDC) as the unit of measure.

The allowable range for Start and End Offset is $\pm 200\text{ VDC}$ (with system gain set to 20). This range is displayed above the selected input box. When a value outside of the allowable range is entered, the input box will turn red.

Amplitude Sweep Type: An Amplitude Sweep can be Linear, Exponential or Logarithmic. Choose the desired sweep type from the drop-down.

When Exponential is chosen as the sweep type, an additional variable, the effective time constant, is added to the properties window. The effective time constant has an allowable range from -8 to +8. Increase or decrease this variable to affect the rate of exponential change. To change the exponential curve from convex to concave, vary the

sign of the effective time constant. See the topic “**Creating an Exponential Sweep**” in the “**Tutorials**” section for more information.

Clip Amplitude: Select the Clip Amplitude check box to enable the waveform clip feature. When enabled, the Clip Amplitude will create a clipped waveform at the voltage specified. The default Clip Amplitude voltage setting is 200 Vp, which is effectively a non-clipped waveform since AC wave amplitude is limited by the system to 200 Vp. Change the Clip Amplitude voltage to a level between 0 and 200 Vp to clip the waveform. NOTE: The default clip amplitude can be changed from 200 Vp to the setting of your choice on the Segment Defaults tab in the Settings window. See the topic “**The Segment Defaults Tab**” in the section “**Settings Window**” for more information.

Frequency Sweep Type: A Frequency Sweep can be Linear, Exponential or Logarithmic. Choose the desired sweep type from the drop-down.

When Exponential is chosen as the sweep type, an additional variable, the effective time constant, is added to the properties window. The effective time constant has an allowable range from -8 to +8. Increase or decrease this variable to affect the rate of exponential change. To change the exponential curve from convex to concave, vary the sign of the effective time constant. See the topic “**Creating an Exponential Sweep**” in the “**Tutorials**” section for more information.

Phase Angle: The Phase Angle property determines the beginning offset of the waveform within the cycle. Phase Angle can be defined using degrees (deg) or radians (rad) as the unit of measure.

The allowable range for Phase Angle is 0 to 360 degrees. This range is displayed above the selected input box. When a value outside of the allowable range is entered, the input box will turn red.

Offset Sweep Type: An Offset Sweep can be Linear, Exponential, or Logarithmic. Choose the desired sweep type from the drop-down.

When Exponential is chosen as the sweep type, an additional variable, the effective time constant, is added to the properties window. The effective time constant has an allowable range from -8 to +8. Increase or decrease this variable to affect the rate of exponential change. To change the exponential curve from convex to concave, vary the sign of the effective time constant. See the topic **“Creating an Exponential Sweep”** in the **“Tutorials”** section for more information.

Duration: The Duration property determines how long the waveform will be generated. Duration can be defined using the microsecond (μs), millisecond (ms), second, (sec), minute (min) or hour (hour) as the unit of measure. When the unit of measure is changed, the 3110A automatically converts the property’s value to the new unit of measure.

The minimum duration is 50 μs . Note that the allowable range displayed above the Duration input box shows the minimum allowable duration as 0 because some wave segments of less than 50 μs can be achieved. Please contact AE Techron Technical Support for information about very short duration segments.

When the duration specified for the waveform has been completed, the 3110A will begin generating the next waveform defined in the test. However, if a Trigger Control follows the just-completed waveform, and the Trigger Control’s “Continue Prev. Wave” property is set to TRUE, the waveform before the Trigger Control will continue indefinitely, regardless of the duration time set in that waveform’s properties.

If no additional waveform has been defined to follow the completed waveform, the system output will stop.

Ripple: Select the Ripple checkbox to enable the Ripple feature. When enabled, Ripple will produce

a modulation effect on an AC wave by superimposing a higher frequency on a lower-frequency fundamental waveform.

Enter the desired **Ripple Amplitude** and **Ripple Frequency** in the provided text boxes. The allowable amplitude range is 0-200 Vp, and the allowable frequency range is 0-300000 Hz. Amplitude can be defined using the units Volts peak (Vp), Volts peak-to-peak (Vpp) or Volts root-mean-square (Vrms). Frequency can be defined using Hertz (Hz) or Kilohertz (kHz) as the unit of measure. When the unit of measure is changed, the 3110A automatically converts the property’s value to the new unit of measure.

Segment Enabled/Disabled: The waveform segment can be set to Enabled (Segment Enabled checkbox checked) or Disabled (unchecked). When enabled, the waveform will be played as part of the test sequence. When unchecked, the waveform will be skipped during the running of the test segment. This can be useful when building or troubleshooting test sequences to skip over long or previously verified segments.

Segment Calibration: Pressing the **Calibration** button will open the Segment Calibration window and allow the user to perform calibration at the segment level. See the topic **“Segment Calibration”** in the section **“Calibration”** for more information.

Segment Calibration for Scripted Variable Loops: When a waveform segment is part of a scripted variable loop, pressing the **Calibration** button will open the Segment Calibration function that allows a calibration test to be run for each segment iteration in the variable loop. See the topic **“Calibration for Scripted Variable Loops”** in the section **“Calibration”** for more information.

6.2 Ripple Wave

The 3110A uses its sinewave generator to create the specified ripple wave output. Select Ripple from the **Add Wave** drop-down when you need to

create a sinusoidal waveform with a frequency up to 300 kHz.

6.2.1 Ripple Wave Properties

Set the ripple waveform properties to specify the characteristics of the wave to be produced at the amplifier output. See **Figure 6.2**.

Amplitude: The Start Amplitude and End Amplitude properties determine the height of the wave from the zero-crossing point to the crest, measured in volts. Amplitude can be defined using the units Volts peak (Vp), Volts peak-to-peak (Vpp) or Volts root-mean-square (Vrms). When the unit of measure is changed, the 3110A automatically converts the property’s value to the new unit of measure. The units of measure used for Start Amplitude and End Amplitude do not need to be the same.

The values for both Start and End Amplitude can be positive or negative, and the allowable range for these values will be determined by the 3110A based on the System Calibration settings (for more information, see the topic “**System Calibration**” in the “**Calibration**” section). The default allowable range is $\pm 200Vp$ (with system gain set to 20). This range is displayed above the selected input box. When a value outside of the allowable range is entered, the input box will turn red.

Frequency: The Start Frequency and End Frequency properties determine the frequency of the

wave in cycles per second (Hertz). Frequency can be defined using Hertz (Hz) or Kilohertz (kHz) as the unit of measure. When the unit of measure is changed, the 3110A automatically converts the property’s value to the new unit of measure. The units of measure used for Start Frequency and End Frequency do not need to be the same.

The allowable minimum value for Start Frequency is 0.1 Hz. The allowable maximum value for End Frequency is 300 kHz. This range is displayed above the selected input box. When a value outside of the allowable range is entered, the input box will turn red.

DC Offset: The Start Offset and End Offset properties supply a constant positive or negative DC voltage on the AC wave. DC Offset is defined in Volts DC (VDC) as the unit of measure.

The allowable range for Start and End Offset is ± 200 VDC (with system gain set to 20). This range is displayed above the selected input box. When a value outside of the allowable range is entered, the input box will turn red.

Amplitude Sweep Type: An Amplitude Sweep can be Linear, Exponential or Logarithmic. Choose the desired sweep type from the drop-down.

When Exponential is chosen as the sweep type, an additional variable, the effective time constant, is added to the properties window. The effective time constant has an allowable range from -8 to

Figure 6.2– Ripple Waveform Properties

+8. Increase or decrease this variable to affect the rate of exponential change. To change the exponential curve from convex to concave, vary the sign of the effective time constant. See the topic **“Creating an Exponential Sweep”** in the **“Tutorials”** section for more information.

Frequency Sweep Type: A Frequency Sweep can be Linear, Exponential or Logarithmic. Choose the desired sweep type from the drop-down.

When Exponential is chosen as the sweep type, an additional variable, the effective time constant, is added to the properties window. The effective time constant has an allowable range from -8 to +8. Increase or decrease this variable to affect the rate of exponential change. To change the exponential curve from convex to concave, vary the sign of the effective time constant. See the topic **“Creating an Exponential Sweep”** in the **“Tutorials”** section for more information.

Phase Angle: The Phase Angle property determines the beginning offset of the waveform within the cycle. Phase Angle can be defined using degrees (deg) or radians (rad) as the unit of measure.

The allowable range for Phase Angle is 0 to 360 degrees. This range is displayed above the selected input box. When a value outside of the allowable range is entered, the input box will turn red.

Offset Sweep Type: An Offset Sweep can be Linear, Exponential, or Logarithmic. Choose the desired sweep type from the drop-down.

When Exponential is chosen as the sweep type, an additional variable, the effective time constant, is added to the properties window. The effective time constant has an allowable range from -8 to +8. Increase or decrease this variable to affect the rate of exponential change. To change the exponential curve from convex to concave, vary the sign of the effective time constant. See the topic **“Creating an Exponential Sweep”** in the **“Tutorials”** section for more information.

Duration: The Duration property determines how long the waveform will be generated. Duration can be defined using the microsecond (μs), millisecond (ms), second, (sec), minute (min) or hour (hour) as the unit of measure. When the unit of measure is changed, the 3110A automatically converts the property's value to the new unit of measure.

The minimum duration is 50 μs . Note that the allowable range displayed above the Duration input box shows the minimum allowable duration as 0 because some wave segments of less than 50 μs can be achieved. Please contact AE Techron Technical Support for information about very short duration segments.

When the duration specified for the waveform has been completed, the 3110A will begin generating the next waveform defined in the test. However, if a Trigger Control follows the just-completed waveform, and the Trigger Control's “Continue Prev. Wave” property is set to TRUE, the waveform before the Trigger Control will continue indefinitely, regardless of the duration time set in that waveform's properties.

If no additional waveform has been defined to follow the completed waveform, the system output will stop.

Segment Enabled/Disabled: The waveform segment can be set to Enabled (Segment Enabled checkbox checked) or Disabled (unchecked). When enabled, the waveform will be played as part of the test sequence. When unchecked, the waveform will be skipped during the running of the test segment. This can be useful when building or troubleshooting test sequences to skip over long or previously verified segments.

Segment Calibration: Pressing the **Calibration** button will open the Segment Calibration window and allow the user to perform calibration at the segment level. See the topic **“Segment Calibration”** in the section **“Calibration”** for more information.

Segment Calibration for Scripted Variable

Loops: When a waveform segment is part of a scripted variable loop, pressing the **Calibration** button will open the Segment Calibration function that allows a calibration test to be run for each segment iteration in the variable loop. See the topic *“Calibration for Scripted Variable Loops”* in the section *“Calibration”* for more information.

6.3 DC Signal

Select DC from the **Add Wave** drop-down when you need to create a positive or negative DC output. Set the following properties to specify the characteristics of the DC output to be produced at the amplifier output (see **Figure 6.3**).

DC Offset: The Start Offset and End Offset properties supply a constant positive or negative DC voltage. DC Offset is defined in Volts DC (VDC) as the unit of measure.

The allowable range for Start and End Offset is ± 200 VDC (with system gain set to 20). This range is displayed above the selected input box. When a value outside of the allowable range is entered, the input box will turn red.

Offset Sweep Type: An Offset Sweep can be Linear, Exponential, or Logarithmic. Choose the desired sweep type from the drop-down.

When Exponential is chosen as the sweep type, an additional variable, the effective time constant, is added to the properties window. The effective time constant has an allowable range from -8 to +8. Increase or decrease this variable to affect the rate of exponential change. To change the exponential curve from convex to concave, vary the

sign of the effective time constant. See the topic *“Creating an Exponential Sweep”* in the *“Tutorials”* section for more information.

.Duration: The Duration property determines how long the waveform will be generated. Duration can be defined using the microsecond (μ s), millisecond (ms), second, (sec), minute (min) or hour (hour) as the unit of measure. When the unit of measure is changed, the 3110A automatically converts the property’s value to the new unit of measure.

The minimum duration is 50 μ s. Note that the allowable range displayed above the Duration input box shows the minimum allowable duration as 0 because some wave segments of less than 50 μ s can be achieved. Please contact AE Techron Technical Support for information about very short duration segments.

When the duration specified for the waveform has been completed, the 3110A will begin generating the next waveform defined in the test. However, if a Trigger Control follows the just-completed waveform, and the Trigger Control’s “Continue Prev. Wave” property is set to TRUE, the waveform before the Trigger Control will continue indefinitely, regardless of the duration time set in that waveform’s properties.

If no additional waveform has been defined to follow the completed waveform, the system output will stop.

Segment Enabled/Disabled: The waveform segment can be set to Enabled (Segment Enabled checkbox checked) or Disabled (unchecked). When enabled, the waveform will be played as

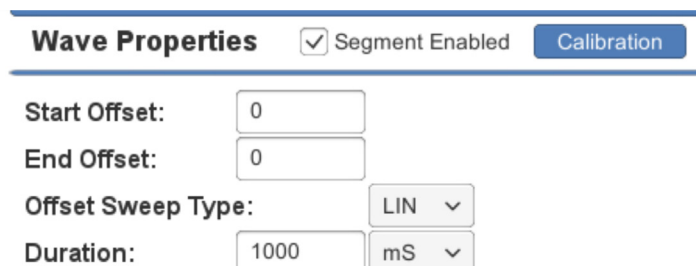

Figure 6.3 – DC Signal Properties

part of the test sequence. When unchecked, the waveform will be skipped during the running of the test segment. This can be useful when building or troubleshooting test sequences to skip over long or previously verified segments.

Segment Calibration: Pressing the **Calibration** button will open the Segment Calibration window and allow the user to perform calibration at the segment level. See the topic “**Segment Calibration**” in the section “**Calibration**” for more information.

Segment Calibration for Scripted Variable

Loops: When a waveform segment is part of a scripted variable loop, pressing the **Calibration** button will open the Segment Calibration function that allows a calibration test to be run for each segment iteration in the variable loop. See the topic “**Calibration for Scripted Variable Loops**” in the section “**Calibration**” for more information.

6.4 Controls

Control segments include Trigger, Fixed Loop, Variable Loop, Template, GPIO Output and LAN Output. Properties for each Control segment are specific to the Control type.

NOTE: GPIO controls, including GPIO Trigger and GPIO Output, are not supported on DSR Series systems.

6.4.1 Trigger Control

The Trigger Control will cause a a running test to pause and wait for an input that will cause the trigger to “release.”

To create a trigger within a test, select the **Trigger** option from the **Add Control** drop-down menu. A Trigger icon will be added to the active test sequence. Drag the trigger icon until it is positioned where you want the trigger to occur within the test sequence. Select the Trigger tab and change the Trigger Type property to one of three trigger types: **user**, **gpio** or **lan**. Then edit the Trigger properties as required.

Control Properties

The screenshot shows a dialog box titled "Control Properties" with a blue header bar. Below the header, there are four rows of settings:

- Trigger Type:** A dropdown menu with "user" selected and a downward arrow.
- Operator Msg:** A text input field containing "Test unit for".
- Display Op. Msg:** A checkbox that is checked.
- Cont. Prev. Wave:** A checkbox that is checked.

Figure 6.4 – User Trigger Properties

User Trigger

The User Trigger option allows a local action to release the trigger. Either pressing the Arrow (RUN) button in the 3110A main window or pressing the spacebar on the keyboard will release a User Trigger. The following properties can be set when the User trigger type is selected (see **Figure 6.4**).

Operator Msg (optional): Enter a message to be displayed as a pop-up in the main window to provide instructions or reminders to the operator.

Display Op. Msg: Check the box (default) to display the operator message. Uncheck the box to prevent the Operator Message from displaying.

Cont. Prev. Waveform: When the trigger is released, the 3110A will begin generating the next waveform in the test sequence. While waiting for the trigger, the 3110A will continue to generate the waveform previous to the trigger control indefinitely until the trigger is released (default). To set the 3110A to not generate any signal between the end of the last waveform and the release of the trigger, uncheck the Trigger’s Continue Prev. Wave property check box.

GPIO Trigger

IMPORTANT: Before configuring the GPIO Trigger, first configure each of the three GPIO ports to function as an input or an output using the **GPIO Setup** controls on the **Configuration** tab located in the Settings window. See the **GPIO Setup** side-

Control Properties

Trigger Type: ▾

GPIO 0 Monitor:

GPIO 1 Monitor: For: ▾

GPIO 5 Monitor:

Cont. Prev. Wave:

Figure 6.5 – GPIO Trigger Properties

bar on the following page for more information.

NOTE: GPIO Trigger is not supported on DSR Series systems.

When a GPIO port is configured as an input, it can be used in a GPIO Trigger segment. When the GPIO Trigger segment is reached in a test sequence, the 3110A will pause and wait for the specified signal to be received on the designated GPIO port. When the signal is received, the test sequence will continue with the next segment following the trigger.

When programmed as an input, the electrical characteristics of each GPIO port is as follows:

	OPEN
GPIO0	0.0V DC
GPIO1	3.3V DC
GPIO5	0.0V DC

Impedance: ≥10 Mohm

The default GPIO input port is GPIO1, which can be pulled low by connection to pin 13 (digital ground). See the **GPIO Setup** sidebar on the following page for more information.

The following properties can be set when the GPIO trigger type is selected: GPIO Monitor (0, 1, or 5) and Cont. Prev. Wave (selected or unselected). See **Figure 6.5**.

GPIO Monitor: Choose the GPIO port that you have previously designated as the GPIO input during GPIO setup. After you have selected a GPIO monitor port, you will be prompted to choose the

logic state, 0 (0.0V DC) or 1 (3.3V DC) that will cause the trigger to be released.

Cont. Prev. Waveform: When the trigger is released, the 3110A will begin generating the next waveform in the test sequence. While waiting for the trigger, the 3110A will continue to generate the waveform previous to the trigger control indefinitely until the trigger is released (default). To set the 3110A to not generate any signal between the end of the last waveform and the release of the trigger, uncheck the Trigger’s Continue Prev. Wave property check box.

LAN Trigger

The LAN Trigger option allows an input signal received on the 3110A’s Ethernet port to cause the trigger to be released. When the LAN Trigger type is selected, the following controls are provided: See **Figure 6.6**.

Client Address: Enter the IP address of the workstation or device on your network that will be sending the Trigger signal.

Output Message (optional): Enter the characters to be sent to the client device on the network to signal that the trigger release message (Input Message) should be sent.

Input Message: Enter the characters that will be sent by the client device to signal the release of the trigger.

Timeout: If no release signal is received from the client device after the timeout period has passed, the 3110A will stop waiting for the trigger signal

GPIO Setup

NOTE: GPIO ports and controls are not supported on DSR Series systems.

Open the Settings window and go to the Configuration tab to configure the GPIO Setup. The GPIO checkboxes are used to configure the usage of the 3110A's three dedicated GPIO ports. Select "Input" or "Output" to configure the port for that use in all test sequences.

After assigning the pins as required for your use or application, press the Save button to save the settings. and then use the corresponding pins to program a GPIO Trigger (input) or GPIO Output segment.

See the topics "Trigger Control: GPIO Trigger" and "GPIO Output Control" for more information.

GPIO Port Wiring: The GPIO ports can be accessed using the 3110A's 15-pin D-sub connector using pins 7 and 14 (refer-

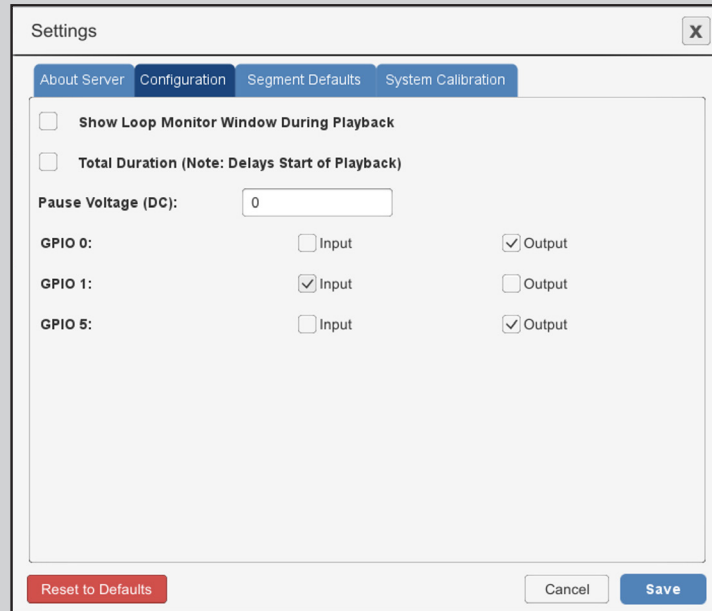
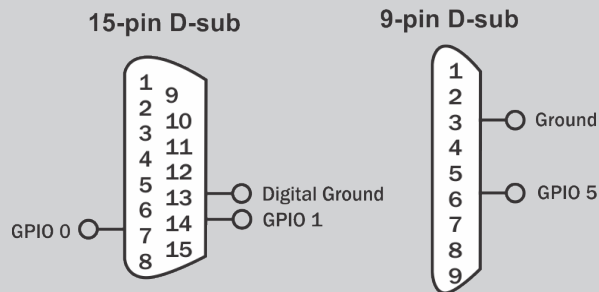

enced to ground on pin 13), and the 9-pin D-sub connector using pin 6 (referenced to ground on pin 3).

Use an opto-coupler or solid-state relay to control the signal state.

IMPORTANT: The GPIO pins are tied directly to the microprocessor and are not isolated. Take care not to exceed maximum ratings as permanent damage can occur. We highly recommend optical isolation (opto-coupler, solid state relay, etc.) be used on all GPIO pins before connecting to external equipment.

and will continue to the next waveform in the test. Enter the time period in milliseconds.

of Retries (optional): When the # of Retries value is set to a number higher than zero, if no release signal is received from the client device after the timeout period has passed, the 3110A will repeat the Timeout period for the number of retries specified before it will continue to the next waveform in the test.

Cont. Prev. Waveform: When the trigger is released, the 3110A will begin generating the next

Trigger Type:

Client Address:

Output Message:

Input Message:

Timeout:

of Retries:

Cont. Prev. Wave:

Figure 6.6 – LAN Trigger Properties

waveform in the test sequence. While waiting for the trigger, the 3110A will continue to generate the waveform previous to the trigger control indefinitely until the trigger is released (default). To set the 3110A to not generate any signal between the end of the last waveform and the release of the trigger, uncheck the Trigger's Continue Prev. Wave property check box.

6.4.2 Fixed Loop Control

When one or more waveforms are positioned between the Fixed Loop Start control and Fixed Loop End control, those waveforms will be generated repeatedly. The number of times the waveforms will be repeated is determined by the Loop Count property found under the Fixed Loop Start tab. See **Figure 6.8**.

To create a fixed loop within a test, select the Fixed Loop option from the Add Control drop-down menu in the 3110A's main window. Two control icons, Fixed Loop Start and Fixed Loop End, will be added to the active test sequence. Drag the waveform(s) to be repeated so they are positioned between the Fixed Loop icons. Select the Fixed Loop Start tab and enter the desired number of loops in the Loop Count property.

6.4.3 Variable Loop Control

The Variable Loop control allows you to create a repeating waveform or waveform sequence with one or more waveform properties that are changed on each loop cycle. Up to four of the following waveform properties can be set as variables within a single Variable Loop: Start Amplitude, End Amplitude, Start Frequency, End Frequency, Start Offset, End Offset, and Duration.

Two types of Variable Loops are available for use: **Linear** and **Script**. Select a linear variable loop when you need to change from one to four wave-

form properties in a linear progression. Select a script variable loop when you need to change waveform properties in a random sequence or using a sequence based on an equation.

Note that segment-level calibration is not available for waveforms defined by a variable loop. If segment-level calibration is required for the test, create each loop as a separate waveform or waveform sequence.

Linear Variable Loops

To create a linear variable loop within a test, select the Variable Loop option from the Add Control drop-down menu in the 3110A's main window. Two control icons, Variable Loop Start and Variable Loop End, will be added to the active test sequence. Drag the waveform(s) to be looped so they are positioned between the Variable Loop icons.

When a waveform is positioned between the two Variable Loop icons, the Properties tab for the waveform will be changed to provide additional drop-down lists to be used to assign variables within the Variable Loop. See **Figure 6.9**.

Find the waveform property to be varied within the loop, and then use the variable assignment drop-down to select a letter. After variable assignment, the input box for that property will be removed to indicate that property will be determined by the variable. Check to make sure that the units being used for the property to be varied are the system default units (Vp for amplitude, Hz for frequency, VDC for offset, and ms for duration).

Next, open the Variable Loop Start tab and check to make sure the variable loop type is set to Linear. Then find the property controls for the variable letter you just assigned. In the Variable Start input box, enter the setting you want for that property at the beginning of the loop (first loop). In the End input box, enter the setting you want for that property at the end of the loop (last loop). Last, input the amount the variable should increase or decrease from one loop to the next. The 3110A software will



Figure 6.8 – Fixed Loop Properties

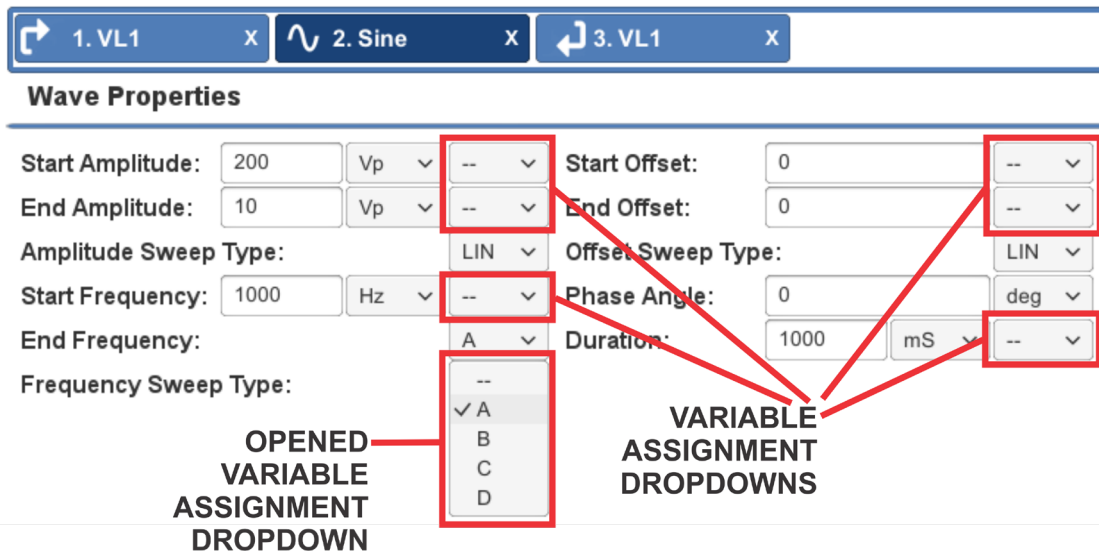

Figure 6.9 – Waveform Properties Added When the Waveform is Placed in a Variable Loop

calculate and display the total number of loops that will result. See **Figure 6.10**.

Adding Additional Variables: Up to four different waveform properties can be assigned as variables within a Variable Loop control. When the properties set for variables will result in a different number of loops to be generated, the 3110A will only generate the lesser number of loops. The actual number of loops to be generated will be highlighted on the Variable Loop Start tab. See **Figure 6.11**.

Once a variable has been created, it can be used on other waveforms contained within the Variable Loop, or on other properties within the same waveform, since the variables are independent of unit. For example, if variable A is defined as starting at 1000 and ending at 10,000 with an increment of 1000, this variable could be used to create a

10-loop repeat with starting frequencies from 1000 Hz to 10,000 Hz increasing in 1000 Hz increments, and variable A could also be used to create a 10-loop repeat with a duration increasing from 1000 ms on the first loop to 10,000 ms on the final loop.

Nested Controls: All Wave Controls (Trigger, Fixed Loop, Variable Loop and Template Playback) can be included within loop controls to become a part of the sequence. When a Variable Loop is included (nested) within another Variable Loop, a maximum of four different variables can be assigned between the two variable loops. Variables assigned in the outer loop are also available to the inner loop and can be reused. However, if the same variable letter is defined in both an outer and an inner Variable Loop, the variable assignment from the outer Variable Loop takes precedence

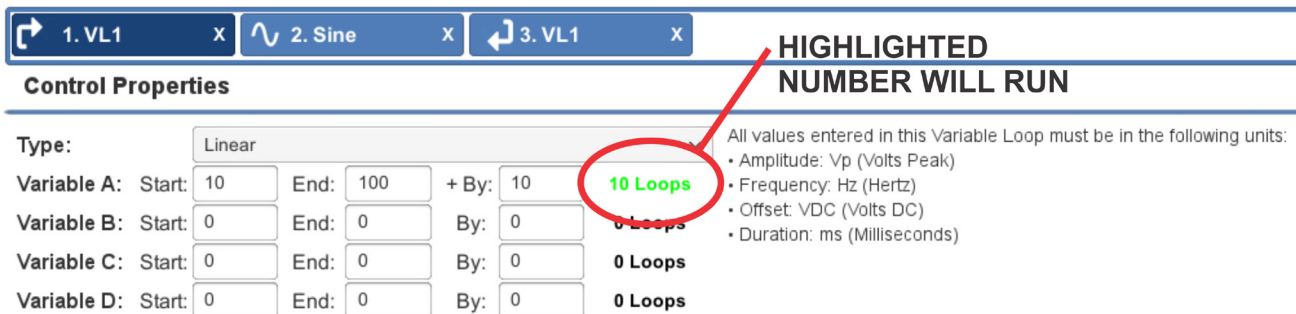

Figure 6.10 – Setting Linear Variable Loop Properties

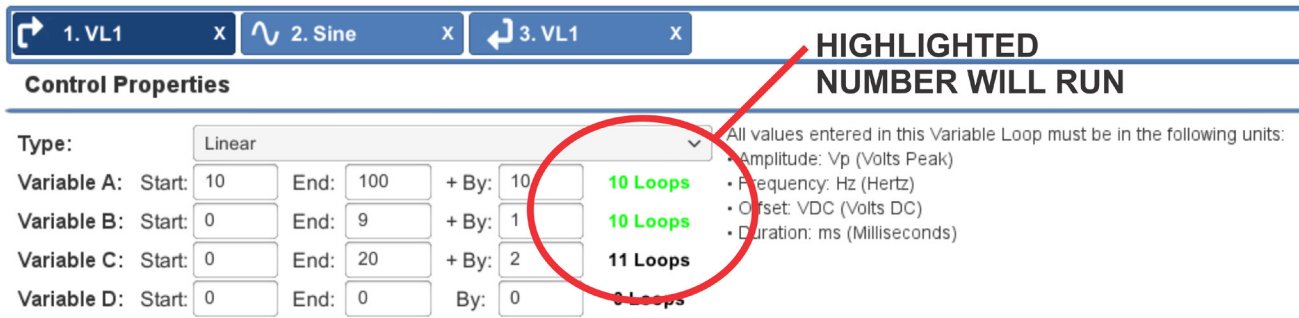

Figure 6.11 – Adding Additional Variables to a Linear Variable Loop

and will be applied to all variables with the same letter assignment.

Scripted Variable Loops

Scripted Variable Loops allow non-linear or equation-based test sequences to be created using data imported from a csv file. Up to four variables can be assigned within the csv file, and an unlimited number of loops using those variables can be

defined.

To create a Script Variable Loop, complete the following steps:

1. Select the Variable Loop option from the Add Control drop-down menu in the 3110A's main window.

Scripted Variable Loops

2. Add the waveform or waveform sequence to be controlled by the script and position it between

the Variable Loop Start and Variable Loop End segments. See **Figure 6.12**.

3. Open the properties window for the Variable Loop Start segment and change the Type property to "Script." A new property labeled "Script Import" will appear in the Control Properties window. See **Figure 6.13**.

4. Press the Choose CSV... button, and the Files window will open. Locate the csv file and open it (Note: A csv file cannot be imported from the USB drive). Any File Notes included in the csv file will appear below

(continued on next page)

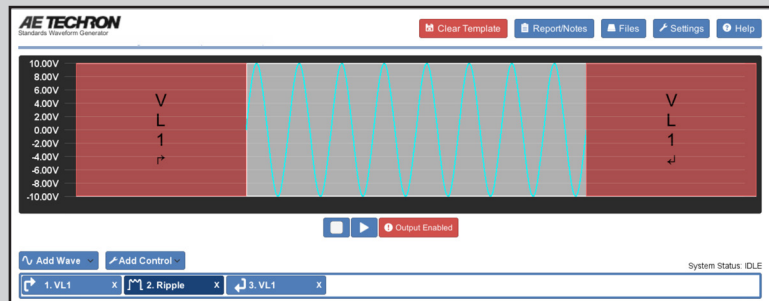

Figure 6.12 – Script VL Creation - Add Waveforms

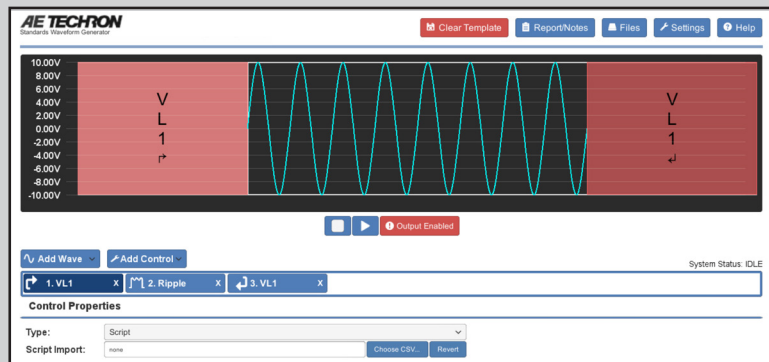

Figure 6.13 – Script VL Creation - Select "Script" Type

Scripted Variable Loops (continued)

the Control Properties in the Properties window. See **Figure 6.14**.

5. Select the waveform tab to open the waveform properties. Assign each variable from the csv file to the waveform properties, as required. See **Figure 6.15**.
6. When all variable have been

assigned, press the Arrow (play button) to begin generating the signal. Note that the test data and test notes imported into the .swg file will be saved with the .swg file. It is not necessary to retain the original csv file in the same location in order to run an .swg file containing a Script Variable Loop.

If the measured output from the scripted variable loop does not match the expected output, you can perform calibration on each iteration of the segments to achieve the desired output. See the topic **“Calibration for Scripted Variable**

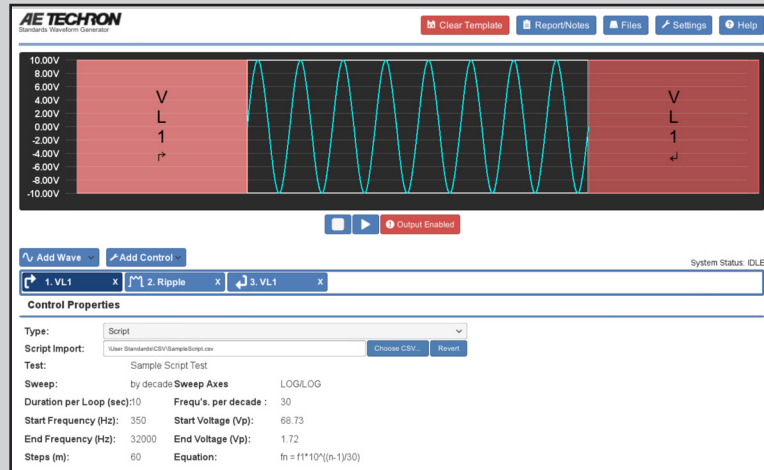

Figure 6.14 – Script VL Creation - Import CSV File

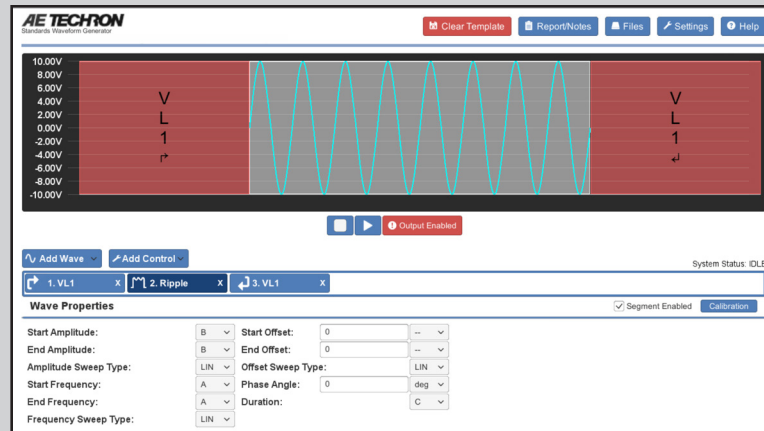

Figure 6.15 – Script VL Creation - Assign Variables

Loops” in the **“Calibration”** section for more information.

6.4.4 Loop Monitor

The Loop Monitor allows the user to track the status of the fixed and variable loops in any test sequence. To enable the Loop Monitor feature, complete the following steps:

1. Press the Settings button to open the Settings window and locate the Loop Monitor selection box on the Configuration tab. Check the box labeled “Show Loop Monitor Window During Playback.” Press the SAVE button to save your selection.
2. Create or open the test to be monitored into the 3110A’s main window. Press the arrow button to start the test.
3. The Loop Monitor Window will appear as a

pop-up in the 3110A main window and display the loops contained in the test sequence, displaying the number of completed loops out of the total loops required to complete the sequence. See **Figure 6.16**.

Note that the Loop Monitor window can be dragged to another location on the screen, if desired.



Figure 6.16 – Using the Loop Monitor

If the test sequence is stopped, the loop monitor count will also be stopped. If the test is restarted, the loop monitor count will be reset to the beginning of the count.

Use the X in the upper right of the Loop Monitor window to close the window. Note that this will also prevent the Loop Monitor window from opening for this or other tests until the Loop Monitor check box is selected again on the Configuration tab in the Settings window.”

6.4.5 Template Control

Use the Template Control when you want to link two or more pre-programmed tests from the Standards Library, or when you want to incorporate a pre-programmed test into a custom test routine you have created. Template controls can be inserted (nested) within Fixed and Variable Loop controls. Template controls inserted into a Variable Loop should first be reviewed by opening the test from the Standards Library. Make note of any variables that have already been assigned in the pre-programmed test to avoid assigning the same variable letter within the Variable Loop.

To load a Template using the Template control into

a test, select the Template option from the Add Control drop-down menu in the 3110A’s main window. A Template icon will be added to the active test sequence. Select the Template tab and press the Choose Template... button to open the file selection dialog box. Locate the .swg file for the test desired, and then double-click on the file name to add it to the Template control. Or you can click on the file name to select the .swg file, and then press the Open button in the file selection dialog to add the test to the Template control.

When a test has been added to a Template control, the file name will appear in the Template properties tab. An Open button is available to allow the associated test to be loaded into the main window. Loading the test into the main window will clear any waveforms or controls currently in the main window. A confirmation dialog also provides the opportunity to save the current test before opening the Template.

6.4.6 GPIO Output Control

IMPORTANT: Before configuring the GPIO Output Control, each GPIO port must first be configured to function as an input or an output using the GPIO

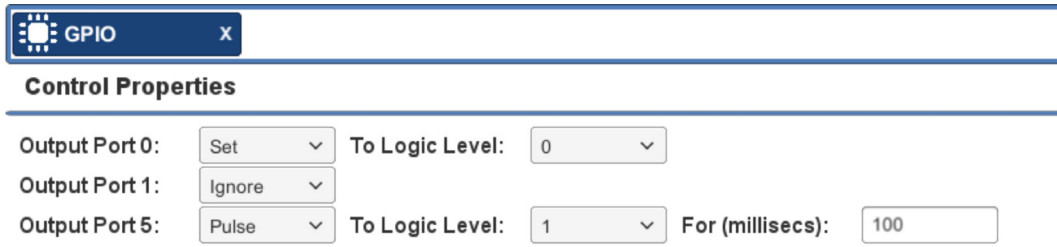

Figure 6.17 – GPIO Output Control Properties

Setup controls on the Configuration tab located under Settings. Please refer to the GPIO Setup instructions provided in the sidebar on the next page.

NOTE: GPIO Output controls are not supported on DSR Series systems.

Use the GPIO Output Control to send a signal through one of the GPIO-enabled pins on the 3110A's 15-pin D-sub and 9-pin D-sub connectors when the GPIO Output segment is played as part of a test sequence.

If any GPIO ports have been configured as an input in the GPIO Setup controls, those ports can be used as a GPIO Trigger only, so you must set those Output Ports to Ignore (no signal) on the GPIO Output control properties. If any GPIO ports have been configured as an output in the GPIO Setup controls, you can configure the GPIO Output segment to send a signal on one or more of those ports, or you can set one or more ports to “ignore,” as desired.

Each GPIO port configured as an output can be set to send a signal when the GPIO Output segment is played as part of a test sequence. The signal type can be configured as Set to the specified value (a continuous signal of 0 or 1), or Pulse (set to the specified value of 0 or 1, and then set to the opposite value after a specified number of milliseconds). See **Figure 6.17**.

An initialization GPIO Output segment should be placed at the beginning of the sequence or loop containing a GPIO Output control with a “Set” logic state to ensure that the GPIO signal is reset to the initial state on subsequent run (arrow) commands (e.g., if the sequence is restarted after the output signal has been sent)..

6.4.7 LAN Output Control

Use the LAN Output Control to send a signal through the 3110A's Ethernet port to a device on the network. See **Figure 6.18**.

IP Address: Enter the IP address of the device on the network to be contacted.

Message: Enter the character or character string to be sent to the targeted device.

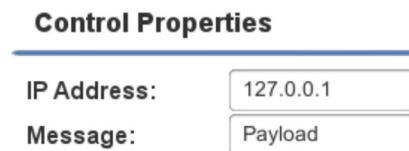

Figure 6.18 – LAN Output Control Properties

GPIO Setup

NOTE: GPIO ports and controls are not supported on DSR Series systems.

Open the Settings window and go to the Configuration tab to configure the GPIO Setup. The GPIO checkboxes are used to configure the usage of the 3110A's three dedicated GPIO ports. Select "Input" or "Output" to configure the port for that use in all test sequences.

After assigning the pins as required for your use or application, press the Save button to save the settings. and then use the corresponding pins to program a GPIO Trigger (input) or GPIO Output segment.

See the topics "**Trigger Control: GPIO Trigger**" and "**GPIO Output Control**" for more information.

GPIO Port Wiring: The GPIO ports can be accessed using the 3110A's 15-pin D-sub connector using pins 7 and 14 (refer-

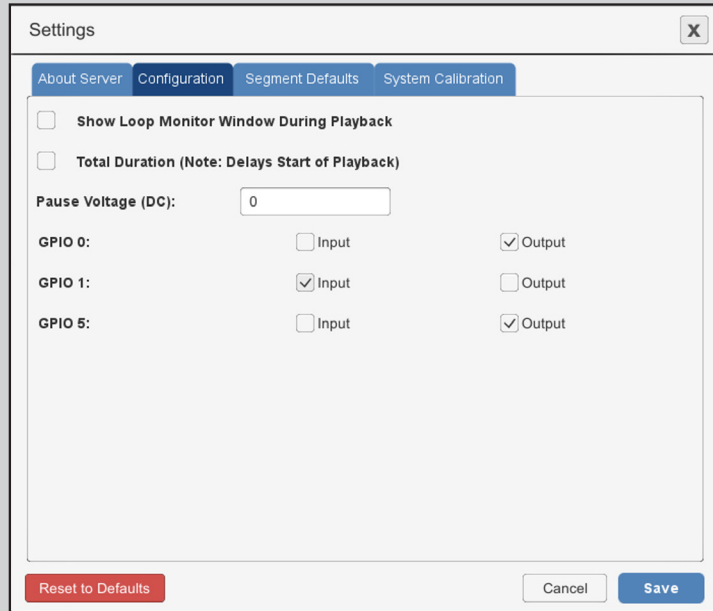
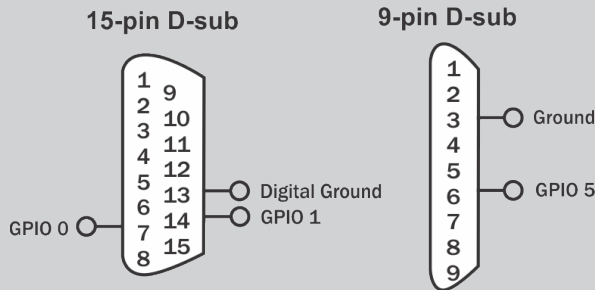

enced to ground on pin 13), and the 9-pin D-sub connector using pin 6 (referenced to ground on pin 3).

Use an opto-coupler or solid-state relay to control the signal state.

IMPORTANT: The GPIO pins are tied directly to the microprocessor and are not isolated. Take care not to exceed maximum ratings as permanent damage can occur. We highly recommend optical isolation (opto-coupler, solid state relay, etc.) be used on all GPIO pins before connecting to external equipment.

7 Creating Reports and Notes

Select the Report/Notes button from the main menu to access the 3110A Report Generator. The Report Generator provides several pre-defined input areas to identify important test information, including company, report #, tester, customer, standard, application and DUT. A Notes input area allows additional information to be added about testing conditions, results, or other factors.

Enter the information you would like included with the report in the text fields provided. Note that the Standard text field will be automatically populated with the test’s file name, but this can be edited, if desired.

After entering the information, save (or resave) the file in the User Standards directory to save the report changes and options. See **Figure 7.1**.

7.4.1 Generating a Report

Press the button “Generate Report” to generate the test report. When operating in the live 3110A environment (whether working locally or across the network) the report information will be saved as an .rtf file in a subdirectory of the User Standards directory, called “Test Reports.” When operating in Demo mode, the report information will be saved as an .rtf file on the workstation’s local hard drive in the Documents directory under the path Demo SWG\Test Reports.

Files in .rtf format can be opened by most text editors and word-processing applications.

Report Generation Options

Show Notes on Open: When a test is saved in the User Standards directory as a custom test file,

Figure 7.1 – Using the Report/Notes Feature

any information entered into the Report Generator will be saved along with the custom test. To automatically open the Report Generator window when the test file opened, select the option “Show Notes on Open.”

Detailed Report: When Detailed Report is selected, a detailed listing of all test waveform parameters and sequences will be included in the generated .rtf file. See the detailed report in **Figure 7.2**.

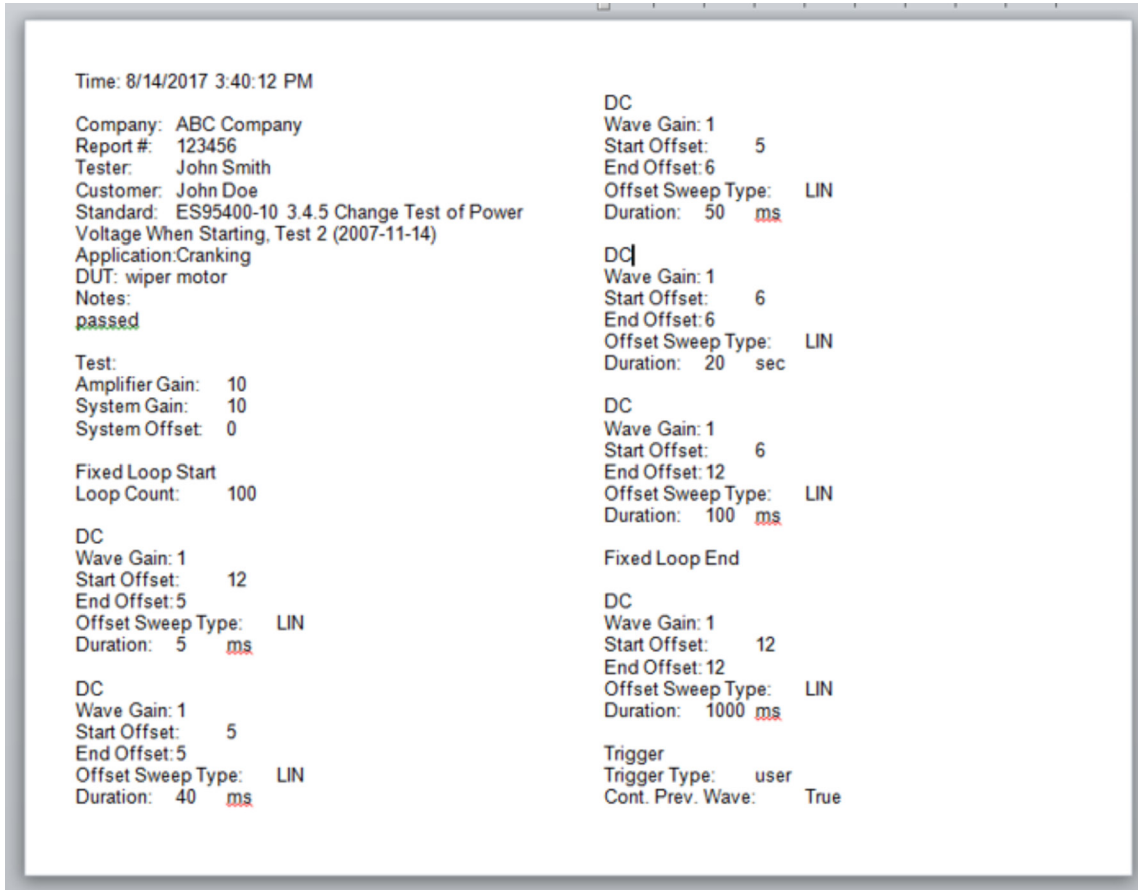

Figure 7.2 – Detailed Report Sample

8 Navigating the Files System

The Files button on the main menu opens the Files window, which provides access to the 3110A's file system, including Network access, the Standards Library, USB storage access, and the User Standards directory. The buttons provided in the Files window provide the functions for navigating the 3110A's internal file system and for mounting/unmounting external access via the USB drive and a connected Ethernet network.

8.4.1 File System Directories

Network: The Network directory provides access to a shared directory on a remote computer connected to a local Ethernet network. Before the shared directory can be accessed, the directory first must be mounted using the Mount Network button. See the instructions for mounting a shared directory on the network under the Mount Network button description later in this section.

The Network directory will be visible at the top level of the Files window when working directly on the 3110A or when accessing the 3110A remotely. However, the Network directory will not appear when working in Demo Mode.

Standards Library: The Standards Library contains the .swg (Standards Waveform Generator) files for a variety of EMC Standards' tests and also contains a CSV directory that contains the CSVScriptTemplate.xlsx and SampleScript.csv files for use in creating Script Variable Loops. The Standards' .swg test files are separated into the main categories, Automotive, Aviation and Industry, and organized in sub-directories by Standard. The Standards library also contains a Factory Test and Setup directory, which contains test routines that may be required during factory or on-site troubleshooting. All files contained in the Standards library are Read-Only.

User Standards: The User Standards directory is a write-able storage space to be used to store user-created custom tests and test variations.

Files saved in the User Standards directory can be copied, altered and deleted. Subdirectories can be added to the User Standards directory.

To open a pre-programmed .swg file, open the Files window and double-click on the Standard's Library directory (or use the Open button), and then locate the test to be used. Double-click on the test name to load the file into the 3110A's main window.

Once loaded, simply press the Arrow button to begin generating the test signal. You can also add or remove individual waveforms and controls from the test sequence, or make changes to the properties of a waveform or control, and then save the modified test in the User Standards directory for later use.

USB drive: The 3110A ships with a USB drive and a 2-port USB Hub. The USB drive contains the SWG Setup.exe file that is used to install the Windows' Remote Access software program on a Windows' computer. For more information, see the topic "**Remote Operation**" in the "**Operation**" section of this manual.

The USB directory will be visible at the top level of the Files window when working directly on the 3110A or when accessing the 3110A remotely. However, the USB directory will not appear when working in Demo Mode. The USB directory can only be opened when the USB drive has been inserted into the the open USB port on the USB Hub.

To remove a USB drive from the USB port, first select the Unmount USB button in the Files window, and then remove the drive from the USB hub.

The USB drive also can be used to create a backup of the .swg files stored in the 3110A and to move .swg files created on a Windows computer running in Demo Mode to the 3110A for use. See the topic "**Working in Demo Mode**" in the "**Op-**

eration” section of this manual.

In addition, the USB drive can be used to update the 3110A software. See the topic **“Updating the 3110A/DSR System”** in the **“Operation”** section of this manual for more information.

SD card: Not supported. Note: Some earlier versions of the 3110A supported SD card use. For these units, the SD card may still appear in the directories list in the Files window. The access for the SD card has been disabled, however, and so the SD card directory can be deleted by the user from the directories list.

8.4.2 File Button Functions

The following functions are available in the Files window:

Go Back: Press the Go Back button to display the files and/or folders one level higher in the 3110A’s file system hierarchy.

Open: Press the Open button to open the selected folder or file. When a folder is opened, the files

and/or folders one level lower in the file system hierarchy will be shown in the Files window. When a file is selected, pressing the Open button will cause the file to be loaded into the 3110A’s main window. Double-clicking on a folder or file in the Files window will also function the same as pressing the Open button.

Delete: Press the Delete button to delete the selected folder(s) or file(s). Confirmation is required before the delete action is completed. Click on additional folder or file names to select multiple items for deletion. Click on a selected item again to clear that item from selection. To clear all selected items, use the Clear Selection button.

New Folder: Press the New Folder button to create a new folder in the User Standards directory. The new folder will be created at the level currently displayed in the Files window.

Deselect All: Press the Deselect All button to deselect all selected items. To deselect individual selected items, click again on the selected item.

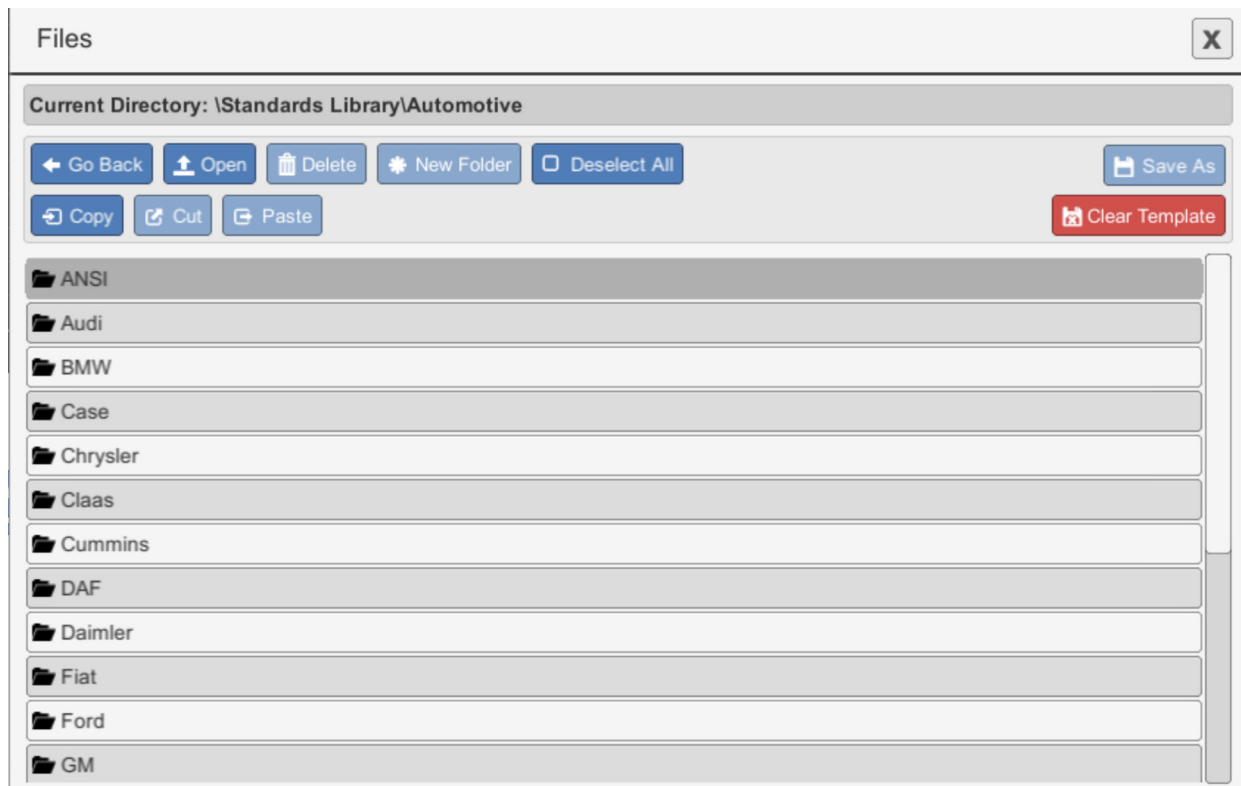

Figure 8.1 – Navigating the 3110A Files System

Save As: Press the Save As button to save the test sequence displayed in the main window as a Standards Waveform Generator (.swg) file. Navigate first to the location in the User Standards directory where you want to save the file. The file will be saved at the level currently displayed in the Files window.

Copy: Use the copy button to make a copy of an .swg file located in the 3110A's internal storage. Click on an .swg file to select, and then press the Copy button to copy the file into the 3110A's temporary memory.

Cut: Use the cut button to cut an .swg file located in the User Standards directory. Click on an .swg file to select, and then press the Cut button remove the file from its storage location in the User Standards directory and copy the file into the 3110A's temporary memory. Note that .swg files located in the Standards library cannot be cut.

Paste: Press the paste button to paste .swg file from the 3110A's temporary memory into the current location in the User Standards directory. Note that .swg files cannot be pasted into the Standards library.

Unmount USB: Press the Unmount USB button to unmount the USB drive before removing the drive from the USB port. If the Unmount USB button is not pressed before removing the USB drive, the 3110A may not recognize the USB drive when it

is returned to the USB port. If the USB drive is not recognized, press the Unmount USB button and then remove the USB drive from the USB port. Then return the USB drive to the USB port to gain access to the USB drive.

Mount Network: Press the Mount Network button to gain access to a shared drive on the local Ethernet network. Pressing the Mount Network button will bring up the Mount Network input window (see **Figure 8.2**). Enter the network path (IP address), including the shared directory. If the shared directory requires a username and password, enter those in the dialog, and then press the Mount button.

Clear Template: Press the Clear Template button to clear all waveform and control segments currently loaded in the main window. Confirmation is required before the main window will be cleared.

Figure 8.2 – Mount Network Input Window

9 Settings Window

The Settings window contains five tabs that provide information and control settings for the 3110A.

NOTE: The Network tab is not available when working on a remote computer in Demo Mode.

9.4.1 The About Server Tab

The **About Server** tab contains the information for the unit’s serial number (later models only) and Software and Firmware versions. It also displays the current IP address for the 3110A. This information is automatically displayed and is used for diagnostic purposes. See **Figure 9.1**.

9.4.2 The Configuration Tab

The **Configuration** tab allows the control for the

loop monitor and total duration features to be toggled on and off, and also provides the controls for GPIO setup. See **Figure 9.2**.

Loop Monitoring:

The **Loop Monitoring** checkbox turns the loop monitor window on or off. When the box is checked, the loop monitor window will be displayed during test playback. For more information about loop monitoring, see the topic “Loop Monitoring.”

Total Duration:

If the **Total Duration** option is selected, the System Status message will display a running count-

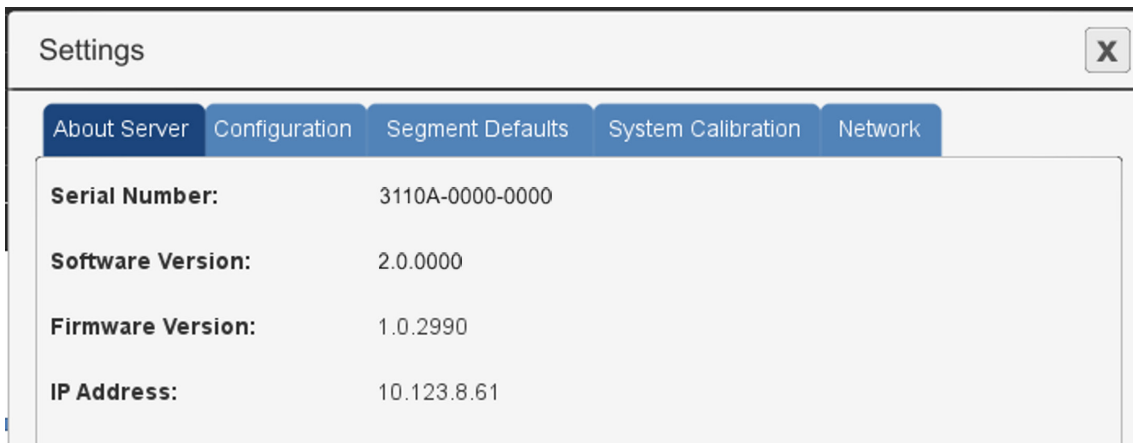

Figure 9.1 – The About Server Tab in the Settings Window

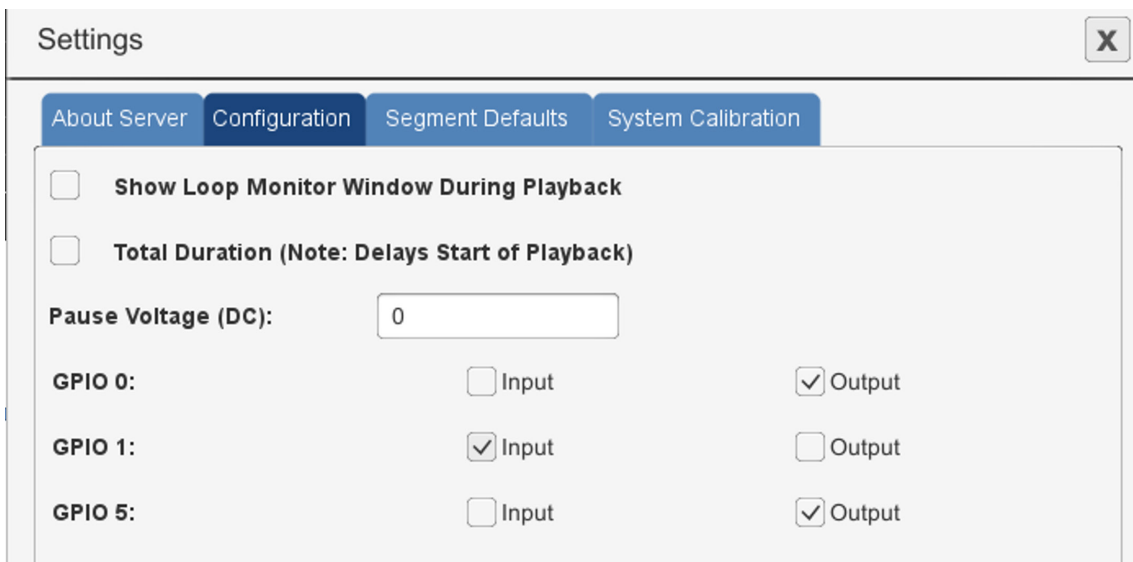

Figure 9.2 – The Configuration Tab in the Settings Window

GPIO Setup

NOTE: GPIO ports and controls are not supported on DSR Series systems.

Open the Settings window and go to the Configuration tab to configure the GPIO Setup. The GPIO checkboxes are used to configure the usage of the 3110A's three dedicated GPIO ports. Select "Input" or "Output" to configure the port for that use in all test sequences.

After assigning the pins as required for your use or application, press the Save button to save the settings. and then use the corresponding pins to program a GPIO Trigger (input) or GPIO Output segment.

See the topics "Trigger Control: GPIO Trigger" and "GPIO Output Control" for more information.

GPIO Port Wiring: The GPIO ports can be accessed using the 3110A's 15-pin D-sub connector using pins 7 and 14 (refer-

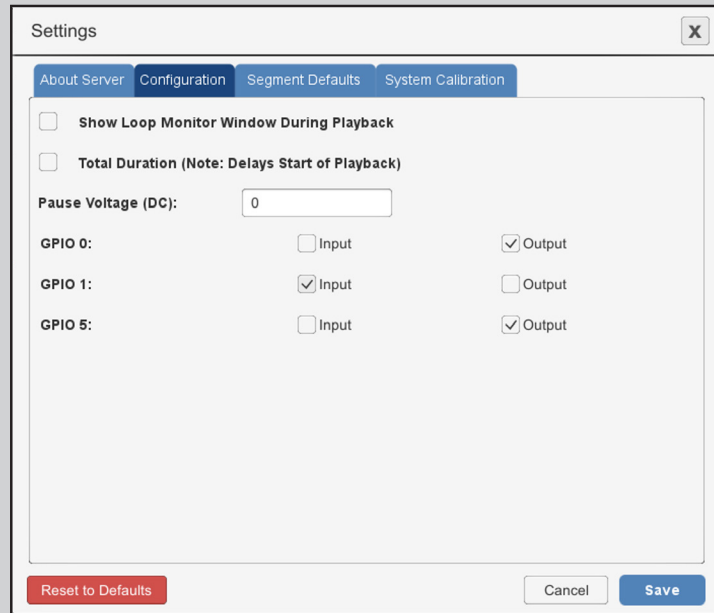
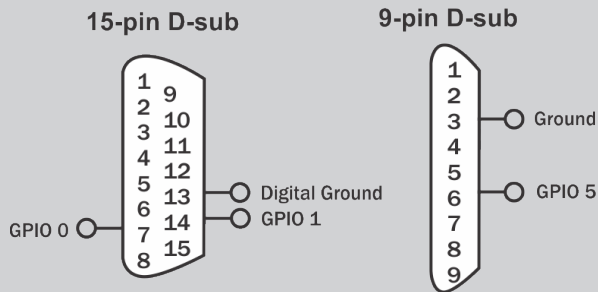

enced to ground on pin 13), and the 9-pin D-sub connector using pin 6 (referenced to ground on pin 3).

Use an opto-coupler or solid-state relay to control the signal state.

IMPORTANT: The GPIO pins are tied directly to the microprocessor and are not isolated. Take care not to exceed maximum ratings as permanent damage can occur. We highly recommend optical isolation (opto-coupler, solid state relay, etc.) be used on all GPIO pins before connecting to external equipment.

down of the time remaining in the test. In addition, the Status Message will display a running count of the test segments as the sequence is being run (i.e., "1 OF X" where "X" is the total number of wave segments and controls included in the test sequence). Note that turning on the Total Duration function may significantly delay the playback of the test.

GPIO Setup:

Please refer to the sidebar (above) for GPIO Setup instructions.

9.4.3 The Segment Defaults Tab

The **Segment Defaults** tab contains the default settings for 3110A waveforms. When a new waveform is added into the main window, the initial waveform properties will be determined by these default settings. To change a default setting, select the input box for that setting, and then type the new setting into the text box or select the new value from the dropdown window. See **Figure 9.3**.

9.4.4 The System Calibration Tab

The **System Calibration** tab holds information about the output generated by the DSR system or

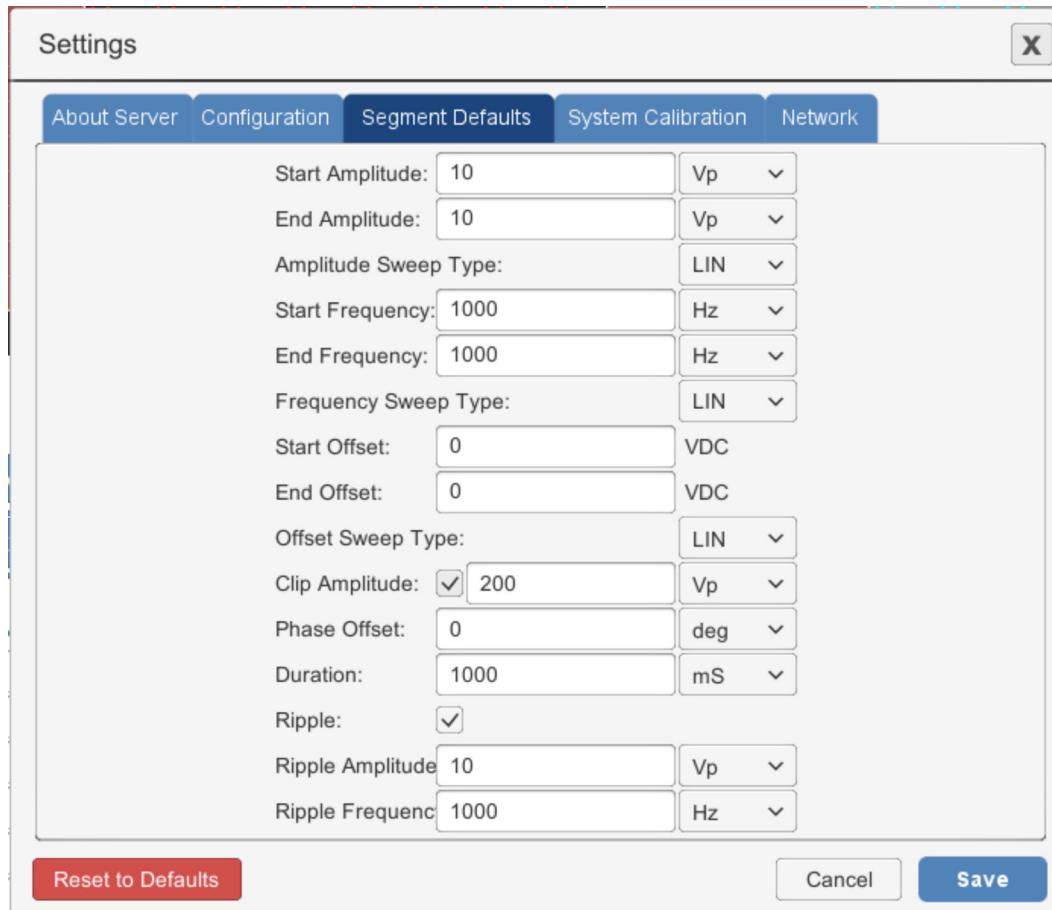

Figure 9.3 – The Segment Defaults Tab in the Settings Window

the combined 3110A/amplifier system. See **Figure 9.4**.

Both system gain and system DC offset information are used by the 3110A to adjust its signal output to produce the expected signal at the amplifier output. By default, a stand-alone 3110A's system gain is set at 20 and the DC offset is set at 0. A DSR system will have a gain setting determined by the number of amplifiers contained in the system.

For accurate operation, the actual gain and offset of your system should be tested by running the Calibration Test. See the **“System Calibration”** topic in the **“Getting Started”** section of this manual for more information.

9.4.5 The Network Tab

The 3110A/DSR System can be assigned a custom Hostname, Static IP Address, LAN Com Port

and LAN EOL Character using the Network tab. See **Figure 9.5**.

NOTE: The Network tab is not available when the 3110A software is in running in Demo Mode on a remote computer.

Assign Hostname

The Hostname will be displayed when browsing a network that has the 3110A/DSR System connected. Newer 3110A systems will display the unit's serial number as the default hostname, while older 3110 units will display the unit's MAC address.

Complete the following steps to assign a custom Hostname:

1. Select the Settings button and then open the Network tab.
2. Enter the desired Hostname in the text box.
3. Press the “Save” button to save the new Hostname.

Settings

About Server Configuration Segment Defaults System Calibration

3110 Output Voltage: 1 Vp Run Calibration Test

Measured Output: 1 Vp

System Gain: 1

Measured DC Offset: 0

Applied DC Offset: 0 V

Reset to Defaults Cancel Save

Figure 9.4 – The System Calibration Tab in the Settings Window

Settings

About Server Configuration Segment Defaults System Calibration Network

Hostname: 0A4FD077156B

Static Address

Address: 192.168.1.2

Netmask: 255.255.255.0

LAN Com Port: 8182

LAN EOL Character: |

Figure 9.5 – The Network Tab in the Settings Window

Assign Static IP

IMPORTANT: Assigning a static IP address to the 3110A or DSR System requires a reboot of the 3110A. Before rebooting the 3110A, make sure all amplifiers connected to the system are disabled. To quickly disable AE Techron amplifiers, press the Stop button on the front panel of any amplifier to

place all connected units in Standby mode. Consult the instructions for non-AE Techron amplifiers to determine the best method for disabling those units. After all amplifiers have been disabled, the 3110A can be safely rebooted by pushing the 3110A's front-panel power switch to the OFF position and then switching back to the ON position.

To return all AE Techron amplifiers to Run status, press the Enable button on the same amplifier that was used to place the amplifiers in Standby mode.

The 3110A is assigned an IP address dynamically when it is added to a network. As long as the 3110A remains connected to the network, this IP address doesn't change and is used as the unit's Gateway address for accessing the 3110A through the network. However, if the 3110A is disconnected from the network, it may be assigned a different IP address when it is again connected.

To avoid having a new IP address dynamically assigned, the 3110A can be assigned a static IP that will remain fixed. Consult with your Network Administrator for the IP Address, Netmask and setting to be used.

Complete the following steps to assign a Static IP Address for the 3110A:

1. Select the Settings button and then open the Network tab.
2. Select the IP Address check box and then enter the IP address assigned by your Network Administrator in the text box. Enter the Netmask information in the appropriate text boxes.
3. Press the "Save" button to save the new information. A dialog message will state that the 3110A must be rebooted to complete the IP address assignment
4. Before rebooting the 3110A, make sure all amplifiers connected to the system are disabled. To quickly disable AE Techron amplifiers, press the Stop button on the front panel of any amplifier to place all connected units in Standby mode. Consult the instructions for non-AE Techron amplifiers to determine the best method for disabling those units. After all amplifiers have been disabled, the 3110A can be safely rebooted by pushing the 3110A's front-panel power switch to the OFF position and then switching back to the ON position. To return all AE Techron amplifiers to Run status, press the Enable button on the same amplifier

that was used to place the amplifiers in Standby mode.

5. Be sure to save any unsaved .swg test files before rebooting the 3110A.

Assign LAN Com Port

IMPORTANT: Assigning a LAN Com Port to the 3110A or DSR System requires a reboot of the 3110A. Before rebooting the 3110A, make sure all amplifiers connected to the system are disabled. To quickly disable AE Techron amplifiers, press the Stop button on the front panel of any amplifier to place all connected units in Standby mode. Consult the instructions for non-AE Techron amplifiers to determine the best method for disabling those units. After all amplifiers have been disabled, the 3110A can be safely rebooted by pushing the 3110A's front-panel power switch to the OFF position and then switching back to the ON position. To return all AE Techron amplifiers to Run status, press the Enable button on the same amplifier that was used to place the amplifiers in Standby mode.

The LAN Com Port is used by the application layer of networked equipment to establish host-to-host connectivity. The 3110A's default LAN Com Port (8182) is already configured for stand-alone and remote operation of the 3110A.

In order to enable the 3110A to be used with other networked signal processing equipment, it may be necessary to change the 3110A's default LAN Com Port. To assign a different port, complete the following steps:

1. Select the Settings button and then open the Network tab.
2. Enter the desired LAN Com Port number in the text box.
3. Press the "Save" button to save the new port number. A dialog message will state that the 3110A must be rebooted to complete the LAN Com Port assignment
4. Before rebooting the 3110A, make sure all amplifiers connected to the system are disabled. To quickly disable AE Techron ampli-

fiers, press the Stop button on the front panel of any amplifier to place all connected units in Standby mode. Consult the instructions for non-AE Techron amplifiers to determine the best method for disabling those units. After all amplifiers have been disabled, the 3110A can be safely rebooted by pushing the 3110A's front-panel power switch to the OFF position and then switching back to the ON position. To return all AE Techron amplifiers to Run status, press the Enable button on the same amplifier that was used to place the amplifiers in Standby mode.

5. Be sure to save any unsaved .swg test files before rebooting the 3110A.

Assign LAN EOL Character

IMPORTANT: Assigning a LAN EOL Character to the 3110A or DSR System requires a reboot of the 3110A. Before rebooting the 3110A, make sure all amplifiers connected to the system are disabled. To quickly disable AE Techron amplifiers, press the Stop button on the front panel of any amplifier to place all connected units in Standby mode. Consult the instructions for non-AE Techron amplifiers to determine the best method for disabling those units. After all amplifiers have been disabled, the 3110A can be safely rebooted by pushing the 3110A's front-panel power switch to the OFF position and then switching back to the ON position. To return all AE Techron amplifiers to Run status, press the Enable button on the same amplifier that was used to place the amplifiers in Standby mode. LAN communications sent from the 3110A to other networked equipment may require a special End-of-Line character to be assigned to ensure proper communications.

To assign a LAN EOL character, complete the following steps:

1. Select the Settings button and then open the Network tab.
2. Enter the desired LAN EOL character in the text box.
3. Press the "Save" button to save the EOL character. A dialog message will state that the 3110A must be rebooted to complete the EOL character assignment
4. Before rebooting the 3110A, make sure all amplifiers connected to the system are disabled. To quickly disable AE Techron amplifiers, press the Stop button on the front panel of any amplifier to place all connected units in Standby mode. Consult the instructions for non-AE Techron amplifiers to determine the best method for disabling those units. After all amplifiers have been disabled, the 3110A can be safely rebooted by pushing the 3110A's front-panel power switch to the OFF position and then switching back to the ON position. To return all AE Techron amplifiers to Run status, press the Enable button on the same amplifier that was used to place the amplifiers in Standby mode.
5. Be sure to save any unsaved .swg test files before rebooting the 3110A.

9.4.6 Save and Reset to Defaults

Select the **Save** button at the bottom of the Settings window to save the new settings in any of the five Settings tabs and close the Settings window. To return all settings to the the factory defaults, select the **Reset to Defaults** button. See **Figure 9.6**.

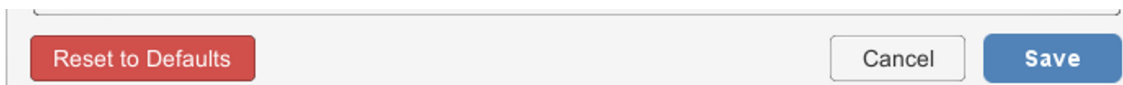

Figure 9.6 – Reset to Defaults and Save Settings

10 Troubleshooting

If the stand-alone 3110A is not operating correctly, review the topics below for help with troubleshooting the problem. For help with DRS system troubleshooting, please refer to the ***DSR Series Operation Manual***. If the condition or error you are experiencing is not listed below, please contact AE Techron Technical Support at 574-295-9495 for additional help.

PROBLEM: 3110A unit does not power on.

A: Check the connection to AC power, both at the AC source and at the back panel of the unit. Check the front-panel power switch to make sure the unit is in the ON position. A fuse located in a compartment above the back panel AC power connector protects the unit. Remove the compartment cover to access the fuse and replace the fuse if needed.

PROBLEM: Experiencing noise during testing.

A: Install the 6:1 attenuator provided with the 3110A. Adjust the system gain as instructed to improve the system's signal-to-noise performance. See the topic ***"Using the 6-to-1 Attenuator"*** in the ***"Operation"*** section of this manual for information.

PROBLEM: The 3110A's Windows Remote software will not load or will not connect remotely to the 3110A; instead, an error message indicates a "version mismatch."

A: The 3110A software and the Windows Remote software versions must match for successful interaction between the two modules. See the topic ***"Updating the 3110A"*** in the ***"Operation"*** section of this manual for information about how to install new versions of these modules.

11 3110A Calibration

11.1 Introduction

This section, along with the calibration tests found in **Appendix A**, provide the guidelines for establishing the performance of key parameters for the 3110A output. It provides instructions for the measurement of the various output signals the 3110A can provide. Although the output of the 3110A can be adjusted via the gain settings, this feature is intended for use in calibrating the system (both the 3110A and the associated amplifier) and not for calibrating the output of the isolated 3110A. For instructions on the calibration of a 3110A/amplifier system, please see the Help topic “System Calibration.”

For the output validation of an isolated 3110A, tolerances and ranges will be provided for a variety of measurements. The results of the measurements will be essentially a “Pass” or “Fail.” Tests conducted according to these instructions should be considered “functional tests” that are intended to confirm the function of the settings of the 3110A. Since fine adjustment of the test system can be accomplished via the 3110A/amplifier System Calibration, the calibration of the isolated 3110A will require only general instrumentation. The procedure should be carried out with the gain set at the anticipated gain to be used in testing. The default gain used in the assessment tables is 20.

11.2 Documentation

Standard SI units commonly found in electrical standard are used for checking the calibration of the 3110A. The minimum requirements for calibration documentation are that the instruments used should be able to accurately measure the quantities within the tolerances provided. Instruments should bear evidence (via a label on the instrument or similar documentation) that the measuring instrument is calibrated. The test tables in **Appendix A** are provided to record the performance of the 3110A in key areas, and to facilitate interaction with the AE Techron when needed.

ANSI Z540 or ISO 17205 calibration with documentation is available as an option.

11.3 Required Instruments

Instruments required are an oscilloscope and a digital multimeter. All measurements should be made into high-impedance instruments. The measurements outlined here do not necessarily require a probe. Using BNC connectors to both instruments is advised. It is assumed that the oscilloscope probe attenuation is set at 1X. Best performance will be attained if the measuring instruments are either isolated (battery powered) or grounded at the same point with the 3110A.

Instruments requirements are suggested requirements. Virtually any calibrated high impedance DMM and oscilloscope will serve. Observe any temperature corrections or other temperature-based requirements for the measuring instruments.

Oscilloscope:

Bandwidth: 50 MHz, minimum

Sample Rate: 1 GS/sec minimum

Automatic Measurements: Frequency, RMS, Peak-to-Peak

Input Impedance (DC): 10M ohm

DMM:

Frequency Range: \pm (% of reading + # of counts)

50 Hz to 10 kHz: 0.3 + 20

10 to 20 kHz: 1 + 40

20 to 100 kHz: 2 + 150

Impedance: Up to 20 M ohm over available ranges

11.4 Connections and Settings

Test connections are made from the front panel Signal Out BNC connector to the test instrument.

Cables and connectors having minimal insertion loss over the bandwidth (DC to 1000 kHz) are required.

An amplifier may be connected to the 3110A, but must be turned off during this series of tests.

No other peripheral connections will affect these tests.

Use common ground or isolated instruments, if possible. Select an environment with minimal radiated noise.

Temperature and run time: Allow the 3110A to run for 20 minutes in a quiescent state.

Gain = Nominally 20.0 for all waveforms; however follow the preliminary steps indicated below.

For the purpose of these tests, a specification of $G = 20$ will mean that the system gain value has been adjusted to deliver an output based on the System Gain Calibration routine.

Use 0 VDC for offset setting for varying waveforms

Sweep Type = LIN for all tests

Where applicable, frequency values should be within 2% of values selected

For the Square waveform, slew rate should be within 3 V/ms for each test

Settings and features not tested: Sweep functions, Control functions, Duration setting and the various Looping features

For all tests, perform the following preliminary steps:

1. Allow the 3110A to warm up for at least 20 minutes prior to performing any operations.
2. Once warmed up, under the Settings/System Calibration tab, run and adjust the DC offset to center the quiescent DC output of the 3110A. See “**System Calibration.**”

11.5 Output Assessments

The assessment of a waveform consists of setting up the 3110A SWG user interface with the values as indicated for each waveform type listed on the various tables. The duration may be set for several seconds, or more depending on the triggering selected. The standard tests included in the Calibration sub-directory are generally set for 1000 seconds, but this can be adjusted, if desired. The test varies voltage and, for alternating waveforms, a range of frequencies is given for each voltage level.

The test waveforms for specific tests can be found in the Standards Library in the Calibration directory.

1. Repeat for the other files.

Notes:

1. Additional voltages and times can be entered by changing the template SWG files

If you have any questions, please contact AE Techron Technical Support at 574-295-9495.

12 3110A Capability Map

The following is a list of limits that will allow you to quickly determine if it is possible for a particular standard to be reproduced by a 3110A.

Waveform limits

Bandwidth

- Sine: DC – 15 kHz
- Square: DC – 100 kHz
- Ripple: DC – 1 MHz

Rise Time

+10V to -10V: <1 μs

Pulse Time Accuracy vs. Duration

- Over 50 μs: ±5% (or ±2 μs, which ever is less)
- 50 μs – 20 μs: ±10%
- 20 μs – 10 μs: ±15%

Maximum Number of Segments in a Single Test (.swg file)

Different segment types are weighted according to the chart below. When added together, if the sum of all weighted segments in the test file is equal to or less than 400, the test sequence can be run in a single test on the 3110A.

Segment Type	Weighting
Scripted Loop	6.0
Wave Segments	2.5
Control Segments	1.5

Test Segment Limits Example:

Number of Wave Segments = 100 x 2.5 = 250
 Number of Control Segments = 20 x 1.5 = 30
Total of Weighted Segments = 280
 280 < 400, so the test sequence can be run in a single test.

Segment Limits in a Loop

Loop Sequence Minimum Segment Duration,

When loop has 127 or fewer segments:

10 μs per segment

Loop Sequence Minimum Segment Duration,

When loop has more than 127 segments:

Total segments in loop must average greater than 1 ms

Loop Segment Limits Example:

Segment 1 = FL1 Loop Count = 100
 Segment 2 = DC Duration = 20 μs
 Segment 3 = DC Duration = 1 ms
 Segment 4 = DC Duration = 2.5 ms
 Segment 5 = FL1 Return
Total Segments of Loop = (Segment 2 + Segment 3 + Segment 4) x 100
Total Segments = 300
Segment Duration Average = (20 μs + 1 ms + 2.5 ms) / 3
Segment Duration Average = 1.17 ms

13 Attributions

Software Attributions

The software graphical user interface for AE Techron’s 3110A Standards Waveform Generator has been developed, in part, using the font software detailed below. The following attributions recognize the copyright/license holders included in this source.

Digitized data copyright (c) 2010 Google Corporation with Reserved Font Arimo, Tinos and Cousine.

Copyright (c) 2012 Red Hat, Inc. with Reserved Font Name Liberation.

This Font Software is licensed under the SIL Open Font License, Version 1.1.

This license is copied below, and is also available with a FAQ at: <http://scripts.sil.org/OFL>

SIL OPEN FONT LICENSE Version 1.1 - 26 February 2007

PREAMBLE The goals of the Open Font License (OFL) are to stimulate worldwide development of collaborative font projects, to support the font creation efforts of academic and linguistic communities, and to provide a free and open framework in which fonts may be shared and improved in partnership with others.

The OFL allows the licensed fonts to be used, studied, modified and redistributed freely as long as they are not sold by themselves. The fonts, including any derivative works, can be bundled, embedded, redistributed and/or sold with any software provided that any reserved names are not used by derivative works. The fonts and derivatives, however, cannot be released under any other type of license. The requirement for fonts to remain under this license does not apply to any document created using the fonts or their derivatives.

DEFINITIONS “Font Software” refers to the set of files released by the Copyright Holder(s) under this license and clearly marked as such. This may include source files, build scripts and documentation.

“Reserved Font Name” refers to any names specified as such after the copyright statement(s).

“Original Version” refers to the collection of Font Software components as distributed by the Copyright Holder(s).

“Modified Version” refers to any derivative made by adding to, deleting, or substituting ? in part or in whole ? any of the components of the Original Version, by changing formats or by porting the Font Software to a new environment.

“Author” refers to any designer, engineer, programmer, technical writer or other person who contributed to the Font Software.

PERMISSION & CONDITIONS

Permission is hereby granted, free of charge, to any person obtaining a copy of the Font Software, to use, study, copy, merge, embed, modify, redistribute, and sell modified and unmodified copies of the Font Software, subject to the following conditions:

- 1) Neither the Font Software nor any of its individual components, in Original or Modified Versions, may be sold by itself.
- 2) Original or Modified Versions of the Font Software may be bundled, redistributed and/or sold with any software, provided that each copy contains the above copyright notice and this license. These can be included either as stand-alone text files, human-readable headers or in the appropriate machine-readable metadata fields within text or binary files as long as those fields can be easily viewed by the user.
- 3) No Modified Version of the Font Software may use the Reserved Font Name(s) unless explicit written permission is granted by the corresponding Copyright Holder. This restriction only applies to the primary font name as presented to the users.
- 4) The name(s) of the Copyright Holder(s) or the Author(s) of the Font Software shall not be used to promote, endorse or advertise any Modified Version, except to acknowledge the contribution(s) of the Copyright Holder(s) and the Author(s) or with their explicit written permission.
- 5) The Font Software, modified or unmodified, in part or in whole, must be distributed entirely under this license, and must not be distributed under any other license. The requirement for fonts to remain under this license does not apply to any document created using the Font Software.

TERMINATION This license becomes null and void if any of the above conditions are not met.

DISCLAIMER THE FONT SOFTWARE IS PROVIDED “AS IS”, WITHOUT WARRANTY OF ANY KIND, EXPRESS OR IMPLIED, INCLUDING BUT NOT LIMITED TO ANY WARRANTIES OF MERCHANTABILITY, FITNESS FOR A PARTICULAR PURPOSE AND NON-INFRINGEMENT OF COPYRIGHT, PATENT, TRADEMARK, OR OTHER RIGHT. IN NO EVENT SHALL THE COPYRIGHT HOLDER BE LIABLE FOR ANY CLAIM, DAMAGES OR OTHER LIABILITY, INCLUDING ANY GENERAL, SPECIAL, INDIRECT, INCIDENTAL, OR CONSEQUENTIAL DAMAGES, WHETHER IN AN ACTION OF CONTRACT, TORT OR OTHERWISE, ARISING FROM, OUT OF THE USE OR INABILITY TO USE THE FONT SOFTWARE OR FROM OTHER DEALINGS IN THE FONT SOFTWARE.

Hardware Attributions

The firmware for AE Techron’s 3110A Standards Waveform Generator has been developed, in part, using Microsemi’s SoftConsole IDE, which incorporates the Newlib subdirec-

tory in its offering. The following attributions recognize the collection of copyright/license holders included in this source.

The newlib subdirectory is a collection of software from several sources. Each file may have its own copyright/license that is embedded in the source file. Unless otherwise noted in the body of the source file(s), the following copyright notices will apply to the contents of the newlib subdirectory:

(1) Red Hat Incorporated - Copyright (c) 1994-2009 Red Hat, Inc. All rights reserved.

This copyrighted material is made available to anyone wishing to use, modify, copy, or redistribute it subject to the terms and conditions of the BSD License. This program is distributed in the hope that it will be useful, but WITHOUT ANY WARRANTY expressed or implied, including the implied warranties of MERCHANTABILITY or FITNESS FOR A PARTICULAR PURPOSE. A copy of this license is available at <http://www.opensource.org/licenses>. Any Red Hat trademarks that are incorporated in the source code or documentation are not subject to the BSD License and may only be used or replicated with the express permission of Red Hat, Inc.

(2) University of California, Berkeley - Copyright (c) 1981-2000 The Regents of the University of California. All rights reserved.

Redistribution and use in source and binary forms, with or without modification, are permitted provided that the following conditions are met:

- Redistributions of source code must retain the above copyright notice, this list of conditions and the following disclaimer.
- Redistributions in binary form must reproduce the above copyright notice, this list of conditions and the following disclaimer in the documentation and/or other materials provided with the distribution.
- Neither the name of the University nor the names of its contributors may be used to endorse or promote products derived from this software without specific prior written permission.

THIS SOFTWARE IS PROVIDED BY THE COPYRIGHT HOLDERS AND CONTRIBUTORS "AS IS" AND ANY EXPRESS OR IMPLIED WARRANTIES, INCLUDING, BUT NOT LIMITED TO, THE IMPLIED WARRANTIES OF MERCHANTABILITY AND FITNESS FOR A PARTICULAR PURPOSE ARE DISCLAIMED. IN NO EVENT SHALL THE COPYRIGHT OWNER OR CONTRIBUTORS BE LIABLE FOR ANY DIRECT, INDIRECT, INCIDENTAL, SPECIAL, EXEMPLARY, OR CONSEQUENTIAL DAMAGES (INCLUDING, BUT NOT LIMITED TO, PROCUREMENT OF SUBSTITUTE GOODS OR SERVICES; LOSS OF USE, DATA, OR PROFITS; OR BUSINESS INTERRUPTION) HOWEVER CAUSED AND ON ANY THEORY OF LIABILITY, WHETHER IN CONTRACT, STRICT LIABILITY, OR TORT (INCLUDING NEGLIGENCE OR OTHERWISE) ARISING IN ANY WAY OUT OF THE USE OF THIS SOFTWARE, EVEN IF ADVISED OF THE POSSIBILITY OF SUCH DAMAGE.

(3) David M. Gay (AT&T 1991, Lucent 1998) - The author of this software is David M. Gay - Copyright (c) 1991 by

AT&T.

Permission to use, copy, modify, and distribute this software for any purpose without fee is hereby granted, provided that this entire notice is included in all copies of any software which is or includes a copy or modification of this software and in all copies of the supporting documentation for such software.

THIS SOFTWARE IS BEING PROVIDED "AS IS", WITHOUT ANY EXPRESS OR IMPLIED WARRANTY. IN PARTICULAR, NEITHER THE AUTHOR NOR AT&T MAKES ANY REPRESENTATION OR WARRANTY OF ANY KIND CONCERNING THE MERCHANTABILITY OF THIS SOFTWARE OR ITS FITNESS FOR ANY PARTICULAR PURPOSE.

The author of this software is David M. Gay. Copyright (C) 1998-2001 by Lucent Technologies - All Rights Reserved

Permission to use, copy, modify, and distribute this software and its documentation for any purpose and without fee is hereby granted, provided that the above copyright notice appear in all copies and that both that the copyright notice and this permission notice and warranty disclaimer appear in supporting documentation, and that the name of Lucent or any of its entities not be used in advertising or publicity pertaining to distribution of the software without specific, written prior permission.

LUCENT DISCLAIMS ALL WARRANTIES WITH REGARD TO THIS SOFTWARE, INCLUDING ALL IMPLIED WARRANTIES OF MERCHANTABILITY AND FITNESS. IN NO EVENT SHALL LUCENT OR ANY OF ITS ENTITIES BE LIABLE FOR ANY SPECIAL, INDIRECT OR CONSEQUENTIAL DAMAGES OR ANY DAMAGES WHATSOEVER RESULTING FROM LOSS OF USE, DATA OR PROFITS, WHETHER IN AN ACTION OF CONTRACT, NEGLIGENCE OR OTHER TORTIOUS ACTION, ARISING OUT OF OR IN CONNECTION WITH THE USE OR PERFORMANCE OF THIS SOFTWARE.

(4) Advanced Micro Devices - Copyright 1989, 1990 Advanced Micro Devices, Inc.

This software is the property of Advanced Micro Devices, Inc (AMD) which specifically grants the user the right to modify, use and distribute this software provided this notice is not removed or altered. All other rights are reserved by AMD.

AMD MAKES NO WARRANTY OF ANY KIND, EXPRESS OR IMPLIED, WITH REGARD TO THIS SOFTWARE. IN NO EVENT SHALL AMD BE LIABLE FOR INCIDENTAL OR CONSEQUENTIAL DAMAGES IN CONNECTION WITH OR ARISING FROM THE FURNISHING, PERFORMANCE, OR USE OF THIS SOFTWARE.

So that all may benefit from your experience, please report any problems or suggestions about this software to the 29K Technical Support Center at 800-29-29-AMD (800-292-9263) in the USA, or 0800-89-1131 in the UK, or 0031-11-1129 in Japan, toll free. The direct dial number is 512-462-4118.

Advanced Micro Devices, Inc.
29K Support Products
Mail Stop 573
5900 E. Ben White Blvd.

Austin, TX 78741
800-292-9263

(4) Sun Microsystems - Copyright (C) 1993 by Sun Microsystems, Inc. All rights reserved.

Developed at SunPro, a Sun Microsystems, Inc. business. Permission to use, copy, modify, and distribute this software is freely granted, provided that this notice is preserved.

(5) Hewlett Packard - (c) Copyright 1986 HEWLETT-PACKARD COMPANY

To anyone who acknowledges that this file is provided "AS IS" without any express or implied warranty: permission to use, copy, modify, and distribute this file for any purpose is hereby granted without fee, provided that the above copyright notice and this notice appears in all copies, and that the name of Hewlett-Packard Company not be used in advertising or publicity pertaining to distribution of the software without specific, written prior permission.

Hewlett-Packard Company makes no representations about the suitability of this software for any purpose.

(6) Hans-Peter Nilsson - Copyright (C) 2001 Hans-Peter Nilsson

Permission to use, copy, modify, and distribute this software is freely granted, provided that the above copyright notice, this notice and the following disclaimer are preserved with no changes.

THIS SOFTWARE IS PROVIDED "AS IS" AND WITHOUT ANY EXPRESS OR IMPLIED WARRANTIES, INCLUDING, WITHOUT LIMITATION, THE IMPLIED WARRANTIES OF MERCHANTABILITY AND FITNESS FOR A PARTICULAR PURPOSE.

(7) Stephane Carrez (m68hc11-elf/m68hc12-elf targets only) - Copyright (C) 1999, 2000, 2001, 2002 Stephane Carrez (stcarrez@nerim.fr)

The authors hereby grant permission to use, copy, modify, distribute, and license this software and its documentation for any purpose, provided that existing copyright notices are retained in all copies and that this notice is included verbatim in any distributions. No written agreement, license, or royalty fee is required for any of the authorized uses.

Modifications to this software may be copyrighted by their authors and need not follow the licensing terms described here, provided that the new terms are clearly indicated on the first page of each file where they apply.

(8) Christopher G. Demetriou - Copyright (c) 2001 Christopher G. Demetriou - All rights reserved.

Redistribution and use in source and binary forms, with or without modification, are permitted provided that the following conditions are met:

1. Redistributions of source code must retain the above copyright notice, this list of conditions and the following disclaimer.
2. Redistributions in binary form must reproduce the above copyright notice, this list of conditions and the following disclaimer in the documentation and/or other materials provided with the distribution.
3. The name of the author may not be used to endorse

or promote products derived from this software without specific prior written permission.

THIS SOFTWARE IS PROVIDED BY THE AUTHOR "AS IS" AND ANY EXPRESS OR IMPLIED WARRANTIES, INCLUDING, BUT NOT LIMITED TO, THE IMPLIED WARRANTIES OF MERCHANTABILITY AND FITNESS FOR A PARTICULAR PURPOSE ARE DISCLAIMED. IN NO EVENT SHALL THE AUTHOR BE LIABLE FOR ANY DIRECT, INDIRECT, INCIDENTAL, SPECIAL, EXEMPLARY, OR CONSEQUENTIAL DAMAGES (INCLUDING, BUT NOT LIMITED TO, PROCUREMENT OF SUBSTITUTE GOODS OR SERVICES; LOSS OF USE, DATA, OR PROFITS; OR BUSINESS INTERRUPTION) HOWEVER CAUSED AND ON ANY THEORY OF LIABILITY, WHETHER IN CONTRACT, STRICT LIABILITY, OR TORT (INCLUDING NEGLIGENCE OR OTHERWISE) ARISING IN ANY WAY OUT OF THE USE OF THIS SOFTWARE, EVEN IF ADVISED OF THE POSSIBILITY OF SUCH DAMAGE.

(8) SuperH, Inc. - Copyright 2002 SuperH, Inc. All rights reserved

This software is the property of SuperH, Inc (SuperH) which specifically grants the user the right to modify, use and distribute this software provided this notice is not removed or altered. All other rights are reserved by SuperH.

SUPERH MAKES NO WARRANTY OF ANY KIND, EXPRESS OR IMPLIED, WITH REGARD TO THIS SOFTWARE. IN NO EVENT SHALL SUPERH BE LIABLE FOR INDIRECT, SPECIAL, INCIDENTAL OR CONSEQUENTIAL DAMAGES IN CONNECTION WITH OR ARISING FROM THE FURNISHING, PERFORMANCE, OR USE OF THIS SOFTWARE.

So that all may benefit from your experience, please report any problems or suggestions about this software to the SuperH Support Center via e-mail at softwaresupport@superh.com.

SuperH, Inc.

405 River Oaks Parkway
San Jose, CA 95134, USA

(9) Royal Institute of Technology - Copyright (c) 1999 Kungliga Tekniska Högskolan (Royal Institute of Technology, Stockholm, Sweden). All rights reserved.

Redistribution and use in source and binary forms, with or without modification, are permitted provided that the following conditions are met:

1. Redistributions of source code must retain the above copyright notice, this list of conditions and the following disclaimer.
2. Redistributions in binary form must reproduce the above copyright notice, this list of conditions and the following disclaimer in the documentation and/or other materials provided with the distribution.
3. Neither the name of KTH nor the names of its contributors may be used to endorse or promote products derived from this software without specific prior written permission.

THIS SOFTWARE IS PROVIDED BY KTH AND ITS CONTRIBUTORS "AS IS" AND ANY EXPRESS OR IMPLIED WARRANTIES, INCLUDING, BUT NOT LIMITED TO,

THE IMPLIED WARRANTIES OF MERCHANTABILITY AND FITNESS FOR A PARTICULAR PURPOSE ARE DISCLAIMED. IN NO EVENT SHALL KTH OR ITS CONTRIBUTORS BE LIABLE FOR ANY DIRECT, INDIRECT, INCIDENTAL, SPECIAL, EXEMPLARY, OR CONSEQUENTIAL DAMAGES (INCLUDING, BUT NOT LIMITED TO, PROCUREMENT OF SUBSTITUTE GOODS OR SERVICES; LOSS OF USE, DATA, OR PROFITS; OR BUSINESS INTERRUPTION) HOWEVER CAUSED AND ON ANY THEORY OF LIABILITY, WHETHER IN CONTRACT, STRICT LIABILITY, OR TORT (INCLUDING NEGLIGENCE OR OTHERWISE) ARISING IN ANY WAY OUT OF THE USE OF THIS SOFTWARE, EVEN IF ADVISED OF THE POSSIBILITY OF SUCH DAMAGE.

(10) Alexey Zelkin - Copyright (c) 2000, 2001 Alexey Zelkin <phantom@FreeBSD.org> All rights reserved.

Redistribution and use in source and binary forms, with or without modification, are permitted provided that the following conditions are met:

1. Redistributions of source code must retain the above copyright notice, this list of conditions and the following disclaimer.
2. Redistributions in binary form must reproduce the above copyright notice, this list of conditions and the following disclaimer in the documentation and/or other materials provided with the distribution.

THIS SOFTWARE IS PROVIDED BY THE AUTHOR AND CONTRIBUTORS ``AS IS'' AND ANY EXPRESS OR IMPLIED WARRANTIES, INCLUDING, BUT NOT LIMITED TO, THE IMPLIED WARRANTIES OF MERCHANTABILITY AND FITNESS FOR A PARTICULAR PURPOSE ARE DISCLAIMED. IN NO EVENT SHALL THE AUTHOR OR CONTRIBUTORS BE LIABLE FOR ANY DIRECT, INDIRECT, INCIDENTAL, SPECIAL, EXEMPLARY, OR CONSEQUENTIAL DAMAGES (INCLUDING, BUT NOT LIMITED TO, PROCUREMENT OF SUBSTITUTE GOODS OR SERVICES; LOSS OF USE, DATA, OR PROFITS; OR BUSINESS INTERRUPTION) HOWEVER CAUSED AND ON ANY THEORY OF LIABILITY, WHETHER IN CONTRACT, STRICT LIABILITY, OR TORT (INCLUDING NEGLIGENCE OR OTHERWISE) ARISING IN ANY WAY OUT OF THE USE OF THIS SOFTWARE, EVEN IF ADVISED OF THE POSSIBILITY OF SUCH DAMAGE.

(11) Andrey A. Chernov - Copyright (C) 1997 by Andrey A. Chernov, Moscow, Russia. All rights reserved.

Redistribution and use in source and binary forms, with or without modification, are permitted provided that the following conditions are met:

1. Redistributions of source code must retain the above copyright notice, this list of conditions and the following disclaimer.
2. Redistributions in binary form must reproduce the above copyright notice, this list of conditions and the following disclaimer in the documentation and/or other materials provided with the distribution.

THIS SOFTWARE IS PROVIDED BY THE AUTHOR ``AS IS'' AND ANY EXPRESS OR IMPLIED WARRANTIES, INCLUDING, BUT NOT LIMITED TO, THE IMPLIED WARRANTIES OF MERCHANTABILITY AND FITNESS FOR A PARTICULAR PURPOSE ARE DISCLAIMED. IN NO EVENT SHALL THE REGENTS OR CONTRIBUTORS

BE LIABLE FOR ANY DIRECT, INDIRECT, INCIDENTAL, SPECIAL, EXEMPLARY, OR CONSEQUENTIAL DAMAGES (INCLUDING, BUT NOT LIMITED TO, PROCUREMENT OF SUBSTITUTE GOODS OR SERVICES; LOSS OF USE, DATA, OR PROFITS; OR BUSINESS INTERRUPTION) HOWEVER CAUSED AND ON ANY THEORY OF LIABILITY, WHETHER IN CONTRACT, STRICT LIABILITY, OR TORT (INCLUDING NEGLIGENCE OR OTHERWISE) ARISING IN ANY WAY OUT OF THE USE OF THIS SOFTWARE, EVEN IF ADVISED OF THE POSSIBILITY OF SUCH DAMAGE.

(12) FreeBSD - Copyright (c) 1997-2002 FreeBSD Project. All rights reserved.

Redistribution and use in source and binary forms, with or without modification, are permitted provided that the following conditions are met:

1. Redistributions of source code must retain the above copyright notice, this list of conditions and the following disclaimer.
2. Redistributions in binary form must reproduce the above copyright notice, this list of conditions and the following disclaimer in the documentation and/or other materials provided with the distribution.

THIS SOFTWARE IS PROVIDED BY THE AUTHOR AND CONTRIBUTORS ``AS IS'' AND ANY EXPRESS OR IMPLIED WARRANTIES, INCLUDING, BUT NOT LIMITED TO, THE IMPLIED WARRANTIES OF MERCHANTABILITY AND FITNESS FOR A PARTICULAR PURPOSE ARE DISCLAIMED. IN NO EVENT SHALL THE AUTHOR OR CONTRIBUTORS BE LIABLE FOR ANY DIRECT, INDIRECT, INCIDENTAL, SPECIAL, EXEMPLARY, OR CONSEQUENTIAL DAMAGES (INCLUDING, BUT NOT LIMITED TO, PROCUREMENT OF SUBSTITUTE GOODS OR SERVICES; LOSS OF USE, DATA, OR PROFITS; OR BUSINESS INTERRUPTION) HOWEVER CAUSED AND ON ANY THEORY OF LIABILITY, WHETHER IN CONTRACT, STRICT LIABILITY, OR TORT (INCLUDING NEGLIGENCE OR OTHERWISE) ARISING IN ANY WAY OUT OF THE USE OF THIS SOFTWARE, EVEN IF ADVISED OF THE POSSIBILITY OF SUCH DAMAGE.

(13) S. L. Moshier - Author: S. L. Moshier. - Copyright (c) 1984,2000 S.L. Moshier

Permission to use, copy, modify, and distribute this software for any purpose without fee is hereby granted, provided that this entire notice is included in all copies of any software which is or includes a copy or modification of this software and in all copies of the supporting documentation for such software.

THIS SOFTWARE IS BEING PROVIDED "AS IS", WITHOUT ANY EXPRESS OR IMPLIED WARRANTY. IN PARTICULAR, THE AUTHOR MAKES NO REPRESENTATION OR WARRANTY OF ANY KIND CONCERNING THE MERCHANTABILITY OF THIS SOFTWARE OR ITS FITNESS FOR ANY PARTICULAR PURPOSE.

(14) Citrus Project - Copyright (c)1999 Citrus Project, All rights reserved.

Redistribution and use in source and binary forms, with or without modification, are permitted provided that the following conditions are met:

1. Redistributions of source code must retain the above

copyright notice, this list of conditions and the following disclaimer.

2. Redistributions in binary form must reproduce the above copyright notice, this list of conditions and the following disclaimer in the documentation and/or other materials provided with the distribution.

THIS SOFTWARE IS PROVIDED BY THE AUTHOR AND CONTRIBUTORS ``AS IS'' AND ANY EXPRESS OR IMPLIED WARRANTIES, INCLUDING, BUT NOT LIMITED TO, THE IMPLIED WARRANTIES OF MERCHANTABILITY AND FITNESS FOR A PARTICULAR PURPOSE ARE DISCLAIMED. IN NO EVENT SHALL THE AUTHOR OR CONTRIBUTORS BE LIABLE FOR ANY DIRECT, INDIRECT, INCIDENTAL, SPECIAL, EXEMPLARY, OR CONSEQUENTIAL DAMAGES (INCLUDING, BUT NOT LIMITED TO, PROCUREMENT OF SUBSTITUTE GOODS OR SERVICES; LOSS OF USE, DATA, OR PROFITS; OR BUSINESS INTERRUPTION) HOWEVER CAUSED AND ON ANY THEORY OF LIABILITY, WHETHER IN CONTRACT, STRICT LIABILITY, OR TORT (INCLUDING NEGLIGENCE OR OTHERWISE) ARISING IN ANY WAY OUT OF THE USE OF THIS SOFTWARE, EVEN IF ADVISED OF THE POSSIBILITY OF SUCH DAMAGE.

(15) Todd C. Miller - Copyright (c) 1998 Todd C. Miller <Todd.Miller@courtesan.com> All rights reserved.

Redistribution and use in source and binary forms, with or without modification, are permitted provided that the following conditions are met:

1. Redistributions of source code must retain the above copyright notice, this list of conditions and the following disclaimer.
2. Redistributions in binary form must reproduce the above copyright notice, this list of conditions and the following disclaimer in the documentation and/or other materials provided with the distribution.
3. The name of the author may not be used to endorse or promote products derived from this software without specific prior written permission.

THIS SOFTWARE IS PROVIDED ``AS IS'' AND ANY EXPRESS OR IMPLIED WARRANTIES, INCLUDING, BUT NOT LIMITED TO, THE IMPLIED WARRANTIES OF MERCHANTABILITY AND FITNESS FOR A PARTICULAR PURPOSE ARE DISCLAIMED. IN NO EVENT SHALL THE AUTHOR BE LIABLE FOR ANY DIRECT, INDIRECT, INCIDENTAL, SPECIAL, EXEMPLARY, OR CONSEQUENTIAL DAMAGES (INCLUDING, BUT NOT LIMITED TO, PROCUREMENT OF SUBSTITUTE GOODS OR SERVICES; LOSS OF USE, DATA, OR PROFITS; OR BUSINESS INTERRUPTION) HOWEVER CAUSED AND ON ANY THEORY OF LIABILITY, WHETHER IN CONTRACT, STRICT LIABILITY, OR TORT (INCLUDING NEGLIGENCE OR OTHERWISE) ARISING IN ANY WAY OUT OF THE USE OF THIS SOFTWARE, EVEN IF ADVISED OF THE POSSIBILITY OF SUCH DAMAGE.

(16) DJ Delorie (i386) - Copyright (C) 1991 DJ Delorie All rights reserved.

Redistribution, modification, and use in source and binary forms is permitted provided that the above copyright notice and following paragraph are duplicated in all such forms.

This file is distributed WITHOUT ANY WARRANTY; without

even the implied warranty of MERCHANTABILITY or FITNESS FOR A PARTICULAR PURPOSE.

(17) Free Software Foundation LGPL License (*-linux* targets only) - Copyright (C) 1990-1999, 2000, 2001 Free Software Foundation, Inc.

This file is part of the GNU C Library. Contributed by Mark Kettenis <kettenis@phys.uva.nl>, 1997.

The GNU C Library is free software; you can redistribute it and/or modify it under the terms of the GNU Lesser General Public License as published by the Free Software Foundation; either version 2.1 of the License, or (at your option) any later version.

The GNU C Library is distributed in the hope that it will be useful, but WITHOUT ANY WARRANTY; without even the implied warranty of MERCHANTABILITY or FITNESS FOR A PARTICULAR PURPOSE. See the GNU Lesser General Public License for more details.

You should have received a copy of the GNU Lesser General Public License along with the GNU C Library; if not, write to the Free Software Foundation, Inc., 51 Franklin Street, Fifth Floor, Boston, MA 02110-1301 USA.

(18) Xavier Leroy LGPL License (i[3456]86-*-*linux* targets only - Copyright (C) 1996 Xavier Leroy (Xavier.Leroy@inria.fr)

This program is free software; you can redistribute it and/or modify it under the terms of the GNU Library General Public License as published by the Free Software Foundation; either version 2 of the License, or (at your option) any later version.

This program is distributed in the hope that it will be useful, but WITHOUT ANY WARRANTY; without even the implied warranty of MERCHANTABILITY or FITNESS FOR A PARTICULAR PURPOSE. See the GNU Library General Public License for more details.

(19) Intel (i960) - Copyright (c) 1993 Intel Corporation

Intel hereby grants you permission to copy, modify, and distribute this software and its documentation. Intel grants this permission provided that the above copyright notice appears in all copies and that both the copyright notice and this permission notice appear in supporting documentation. In addition, Intel grants this permission provided that you prominently mark as "not part of the original" any modifications made to this software or documentation, and that the name of Intel Corporation not be used in advertising or publicity pertaining to distribution of the software or the documentation without specific written prior permission.

Intel Corporation provides this AS IS, WITHOUT ANY WARRANTY, EXPRESS OR IMPLIED, INCLUDING, WITHOUT LIMITATION, ANY WARRANTY OF MERCHANTABILITY OR FITNESS FOR A PARTICULAR PURPOSE. Intel makes no guarantee or representations regarding the use of, or the results of the use of, the software and documentation in terms of correctness, accuracy, reliability, currentness, or otherwise; and you rely on the software, documentation and results solely at your own risk.

IN NO EVENT SHALL INTEL BE LIABLE FOR ANY LOSS OF USE, LOSS OF BUSINESS, LOSS OF PROFITS, INDIRECT, INCIDENTAL, SPECIAL OR CONSEQUENTIAL DAMAGES OF ANY KIND. IN NO EVENT SHALL INTEL'S

TOTAL LIABILITY EXCEED THE SUM PAID TO INTEL FOR THE PRODUCT LICENSED HEREUNDER.

(20) Hewlett-Packard (hppa targets only) - (c) Copyright 1986 HEWLETT-PACKARD COMPANY

To anyone who acknowledges that this file is provided "AS IS" without any express or implied warranty: permission to use, copy, modify, and distribute this file for any purpose is hereby granted without fee, provided that the above copyright notice and this notice appears in all copies, and that the name of Hewlett-Packard Company not be used in advertising or publicity pertaining to distribution of the software without specific, written prior permission.

Hewlett-Packard Company makes no representations about the suitability of this software for any purpose.

(21) Henry Spencer (only *-linux targets) - Copyright 1992, 1993, 1994 Henry Spencer. All rights reserved.

This software is not subject to any license of the American Telephone and Telegraph Company or of the Regents of the University of California.

Permission is granted to anyone to use this software for any purpose on any computer system, and to alter it and redistribute it, subject to the following restrictions:

1. The author is not responsible for the consequences of use of this software, no matter how awful, even if they arise from flaws in it.
2. The origin of this software must not be misrepresented, either by explicit claim or by omission. Since few users ever read sources, credits must appear in the documentation.
3. Altered versions must be plainly marked as such, and must not be misrepresented as being the original software. Since few users ever read sources, credits must appear in the documentation.
4. This notice may not be removed or altered.

(22) Mike Barcroft - Copyright (c) 2001 Mike Barcroft <mike@FreeBSD.org> All rights reserved.

Redistribution and use in source and binary forms, with or without modification, are permitted provided that the following conditions are met:

1. Redistributions of source code must retain the above copyright notice, this list of conditions and the following disclaimer.
2. Redistributions in binary form must reproduce the above copyright notice, this list of conditions and the following disclaimer in the documentation and/or other materials provided with the distribution.

THIS SOFTWARE IS PROVIDED BY THE AUTHOR AND CONTRIBUTORS "AS IS" AND ANY EXPRESS OR IMPLIED WARRANTIES, INCLUDING, BUT NOT LIMITED TO, THE IMPLIED WARRANTIES OF MERCHANTABILITY AND FITNESS FOR A PARTICULAR PURPOSE ARE DISCLAIMED. IN NO EVENT SHALL THE AUTHOR OR CONTRIBUTORS BE LIABLE FOR ANY DIRECT, INDIRECT, INCIDENTAL, SPECIAL, EXEMPLARY, OR CONSEQUENTIAL DAMAGES (INCLUDING, BUT NOT LIMITED TO, PROCUREMENT OF SUBSTITUTE GOODS OR SERVICES; LOSS OF USE, DATA, OR PROFITS; OR BUSINESS INTERRUPTION) HOWEVER CAUSED AND ON ANY THEORY OF LIABILITY, WHETHER IN CON-

TRACT, STRICT LIABILITY, OR TORT (INCLUDING NEGLIGENCE OR OTHERWISE) ARISING IN ANY WAY OUT OF THE USE OF THIS SOFTWARE, EVEN IF ADVISED OF THE POSSIBILITY OF SUCH DAMAGE.

(23) Konstantin Chuguev (--enable-newlib-iconv) - Copyright (c) 1999, 2000 Konstantin Chuguev. All rights reserved.

Redistribution and use in source and binary forms, with or without modification, are permitted provided that the following conditions are met:

1. Redistributions of source code must retain the above copyright notice, this list of conditions and the following disclaimer.
2. Redistributions in binary form must reproduce the above copyright notice, this list of conditions and the following disclaimer in the documentation and/or other materials provided with the distribution.

THIS SOFTWARE IS PROVIDED BY THE AUTHOR AND CONTRIBUTORS "AS IS" AND ANY EXPRESS OR IMPLIED WARRANTIES, INCLUDING, BUT NOT LIMITED TO, THE IMPLIED WARRANTIES OF MERCHANTABILITY AND FITNESS FOR A PARTICULAR PURPOSE ARE DISCLAIMED. IN NO EVENT SHALL THE AUTHOR OR CONTRIBUTORS BE LIABLE FOR ANY DIRECT, INDIRECT, INCIDENTAL, SPECIAL, EXEMPLARY, OR CONSEQUENTIAL DAMAGES (INCLUDING, BUT NOT LIMITED TO, PROCUREMENT OF SUBSTITUTE GOODS OR SERVICES; LOSS OF USE, DATA, OR PROFITS; OR BUSINESS INTERRUPTION) HOWEVER CAUSED AND ON ANY THEORY OF LIABILITY, WHETHER IN CONTRACT, STRICT LIABILITY, OR TORT (INCLUDING NEGLIGENCE OR OTHERWISE) ARISING IN ANY WAY OUT OF THE USE OF THIS SOFTWARE, EVEN IF ADVISED OF THE POSSIBILITY OF SUCH DAMAGE.

iconv (Charset Conversion Library) v2.0

(24) Artem Bityuckiy (--enable-newlib-iconv) - Copyright (c) 2003, Artem B. Bityuckiy, SoftMine Corporation. Rights transferred to Franklin Electronic Publishers.

Redistribution and use in source and binary forms, with or without modification, are permitted provided that the following conditions are met:

1. Redistributions of source code must retain the above copyright notice, this list of conditions and the following disclaimer.
2. Redistributions in binary form must reproduce the above copyright notice, this list of conditions and the following disclaimer in the documentation and/or other materials provided with the distribution.

THIS SOFTWARE IS PROVIDED BY THE AUTHOR AND CONTRIBUTORS "AS IS" AND

ANY EXPRESS OR IMPLIED WARRANTIES, INCLUDING, BUT NOT LIMITED TO, THE IMPLIED WARRANTIES OF MERCHANTABILITY AND FITNESS FOR A PARTICULAR PURPOSE ARE DISCLAIMED. IN NO EVENT SHALL THE AUTHOR OR CONTRIBUTORS BE LIABLE FOR ANY DIRECT, INDIRECT, INCIDENTAL, SPECIAL, EXEMPLARY, OR CONSEQUENTIAL DAMAGES (INCLUDING, BUT NOT LIMITED TO, PROCUREMENT OF SUBSTI-

TUTE GOODS OR SERVICES; LOSS OF USE, DATA, OR PROFITS; OR BUSINESS INTERRUPTION) HOWEVER CAUSED AND ON ANY THEORY OF LIABILITY, WHETHER IN CONTRACT, STRICT LIABILITY, OR TORT (INCLUDING NEGLIGENCE OR OTHERWISE) ARISING IN ANY WAY OUT OF THE USE OF THIS SOFTWARE, EVEN IF ADVISED OF THE POSSIBILITY OF SUCH DAMAGE.

(25) IBM, Sony, Toshiba (only spu-* targets) - (C) Copyright 2001,2006, International Business Machines Corporation, Sony Computer Entertainment, Incorporated, Toshiba Corporation, All rights reserved.

Redistribution and use in source and binary forms, with or without modification, are permitted provided that the following conditions are met:

- Redistributions of source code must retain the above copyright notice, this list of conditions and the following disclaimer.
- Redistributions in binary form must reproduce the above copyright notice, this list of conditions and the following disclaimer in the documentation and/or other materials provided with the distribution.
- Neither the names of the copyright holders nor the names of their contributors may be used to endorse or promote products derived from this software without specific prior written permission.

THIS SOFTWARE IS PROVIDED BY THE COPYRIGHT HOLDERS AND CONTRIBUTORS "AS IS" AND ANY EXPRESS OR IMPLIED WARRANTIES, INCLUDING, BUT NOT LIMITED TO, THE IMPLIED WARRANTIES OF MERCHANTABILITY AND FITNESS FOR A PARTICULAR PURPOSE ARE DISCLAIMED. IN NO EVENT SHALL THE COPYRIGHT OWNER OR CONTRIBUTORS BE LIABLE FOR ANY DIRECT, INDIRECT, INCIDENTAL, SPECIAL, EXEMPLARY, OR CONSEQUENTIAL DAMAGES (INCLUDING, BUT NOT LIMITED TO, PROCUREMENT OF SUBSTITUTE GOODS OR SERVICES; LOSS OF USE, DATA, OR PROFITS; OR BUSINESS INTERRUPTION) HOWEVER CAUSED AND ON ANY THEORY OF LIABILITY, WHETHER IN CONTRACT, STRICT LIABILITY, OR TORT (INCLUDING NEGLIGENCE OR OTHERWISE) ARISING IN ANY WAY OUT OF THE USE OF THIS SOFTWARE, EVEN IF ADVISED OF THE POSSIBILITY OF SUCH DAMAGE.

(26) - Alex Tatmanjants (targets using libc/posix) - Copyright (c) 1995 Alex Tatmanjants <alex@elvisti.kiev.ua> at Electronni Visti IA, Kiev, Ukraine. All rights reserved.

Redistribution and use in source and binary forms, with or without modification, are permitted provided that the following conditions are met:

1. Redistributions of source code must retain the above copyright notice, this list of conditions and the following disclaimer.
2. Redistributions in binary form must reproduce the above copyright notice, this list of conditions and the following disclaimer in the documentation and/or other materials provided with the distribution.

THIS SOFTWARE IS PROVIDED BY THE AUTHOR "AS IS" AND ANY EXPRESS OR IMPLIED WARRANTIES, INCLUDING, BUT NOT LIMITED TO, THE IMPLIED WARRANTIES OF MERCHANTABILITY AND FITNESS FOR A PARTICULAR PURPOSE ARE DISCLAIMED. IN NO EVENT SHALL THE AUTHOR BE LIABLE FOR ANY DIRECT, INDIRECT, INCIDENTAL, SPECIAL, EXEMPLARY, OR CONSEQUENTIAL DAMAGES (INCLUDING, BUT NOT LIMITED TO, PROCUREMENT OF SUBSTITUTE GOODS OR SERVICES; LOSS OF USE, DATA, OR PROFITS; OR BUSINESS INTERRUPTION) HOWEVER CAUSED AND ON ANY THEORY OF LIABILITY, WHETHER IN CONTRACT, STRICT LIABILITY, OR TORT (INCLUDING NEGLIGENCE OR OTHERWISE) ARISING IN ANY WAY OUT OF THE USE OF THIS SOFTWARE, EVEN IF ADVISED OF THE POSSIBILITY OF SUCH DAMAGE.

(27) - M. Warner Losh (targets using libc/posix) - Copyright (c) 1998, M. Warner Losh <imp@freebsd.org> All rights reserved.

Redistribution and use in source and binary forms, with or without modification, are permitted provided that the following conditions are met:

3. Redistributions of source code must retain the above copyright notice, this list of conditions and the following disclaimer.
4. Redistributions in binary form must reproduce the above copyright notice, this list of conditions and the following disclaimer in the documentation and/or other materials provided with the distribution.

THIS SOFTWARE IS PROVIDED BY THE AUTHOR AND CONTRIBUTORS "AS IS" AND ANY EXPRESS OR IMPLIED WARRANTIES, INCLUDING, BUT NOT LIMITED TO, THE IMPLIED WARRANTIES OF MERCHANTABILITY AND FITNESS FOR A PARTICULAR PURPOSE ARE DISCLAIMED. IN NO EVENT SHALL THE AUTHOR OR CONTRIBUTORS BE LIABLE FOR ANY DIRECT, INDIRECT, INCIDENTAL, SPECIAL, EXEMPLARY, OR CONSEQUENTIAL DAMAGES (INCLUDING, BUT NOT LIMITED TO, PROCUREMENT OF SUBSTITUTE GOODS OR SERVICES; LOSS OF USE, DATA, OR PROFITS; OR BUSINESS INTERRUPTION) HOWEVER CAUSED AND ON ANY THEORY OF LIABILITY, WHETHER IN CONTRACT, STRICT LIABILITY, OR TORT (INCLUDING NEGLIGENCE OR OTHERWISE) ARISING IN ANY WAY OUT OF THE USE OF THIS SOFTWARE, EVEN IF ADVISED OF THE POSSIBILITY OF SUCH DAMAGE.

(28) - Andrey A. Chernov (targets using libc/posix) - copyright (C) 1996 by Andrey A. Chernov, Moscow, Russia. All rights reserved.

Redistribution and use in source and binary forms, with or without modification, are permitted provided that the following conditions are met:

1. Redistributions of source code must retain the above copyright notice, this list of conditions and the following disclaimer.
2. Redistributions in binary form must reproduce the above copyright notice, this list of conditions and the following disclaimer in the documentation and/or other materials provided with the distribution.

THIS SOFTWARE IS PROVIDED BY THE AUTHOR ``AS IS" AND ANY EXPRESS OR IMPLIED WARRANTIES, INCLUDING, BUT NOT LIMITED TO, THE IMPLIED WARRANTIES OF MERCHANTABILITY AND FITNESS FOR A PARTICULAR PURPOSE ARE DISCLAIMED. IN NO EVENT SHALL THE REGENTS OR CONTRIBUTORS BE LIABLE FOR ANY DIRECT, INDIRECT, INCIDENTAL, SPECIAL, EXEMPLARY, OR CONSEQUENTIAL DAMAGES (INCLUDING, BUT NOT LIMITED TO, PROCUREMENT OF SUBSTITUTE GOODS OR SERVICES; LOSS OF USE, DATA, OR PROFITS; OR BUSINESS INTERRUPTION) HOWEVER CAUSED AND ON ANY THEORY OF LIABILITY, WHETHER IN CONTRACT, STRICT LIABILITY, OR TORT (INCLUDING NEGLIGENCE OR OTHERWISE) ARISING IN ANY WAY OUT OF THE USE OF THIS SOFTWARE, EVEN IF ADVISED OF THE POSSIBILITY OF SUCH DAMAGE.

(29) - Daniel Eischen (targets using libc/posix) - Copyright (c) 2001 Daniel Eischen <deischen@FreeBSD.org> All rights reserved.

Redistribution and use in source and binary forms, with or without modification, are permitted provided that the following conditions are met:

1. Redistributions of source code must retain the above copyright notice, this list of conditions and the following disclaimer.
2. Redistributions in binary form must reproduce the above copyright notice, this list of conditions and the following disclaimer in the documentation and/or other materials provided with the distribution.

THIS SOFTWARE IS PROVIDED BY THE AUTHOR AND CONTRIBUTORS ``AS IS" AND ANY EXPRESS OR IMPLIED WARRANTIES, INCLUDING, BUT NOT LIMITED TO, THE IMPLIED WARRANTIES OF MERCHANTABILITY AND FITNESS FOR A PARTICULAR PURPOSE ARE DISCLAIMED. IN NO EVENT SHALL THE REGENTS OR CONTRIBUTORS BE LIABLE FOR ANY DIRECT, INDIRECT, INCIDENTAL, SPECIAL, EXEMPLARY, OR CONSEQUENTIAL DAMAGES (INCLUDING, BUT NOT LIMITED TO, PROCUREMENT OF SUBSTITUTE GOODS OR SERVICES; LOSS OF USE, DATA, OR PROFITS; OR BUSINESS INTERRUPTION) HOWEVER CAUSED AND ON ANY THEORY OF LIABILITY, WHETHER IN CONTRACT, STRICT LIABILITY, OR TORT (INCLUDING NEGLIGENCE OR OTHERWISE) ARISING IN ANY WAY OUT OF THE USE OF THIS SOFTWARE, EVEN IF ADVISED OF THE POSSIBILITY OF SUCH DAMAGE.

(30) - Jon Beniston (only lm32-* targets) - Contributed by Jon Beniston <jon@beniston.com>

Redistribution and use in source and binary forms, with or without modification, are permitted provided that the following conditions are met:

1. Redistributions of source code must retain the above copyright notice, this list of conditions and the following disclaimer.
2. Redistributions in binary form must reproduce the above copyright notice, this list of conditions and the following disclaimer in the documentation and/or other materials provided with the distribution.

THIS SOFTWARE IS PROVIDED BY THE AUTHOR AND

CONTRIBUTORS ``AS IS" AND ANY EXPRESS OR IMPLIED WARRANTIES, INCLUDING, BUT NOT LIMITED TO, THE IMPLIED WARRANTIES OF MERCHANTABILITY AND FITNESS FOR A PARTICULAR PURPOSE ARE DISCLAIMED. IN NO EVENT SHALL THE AUTHOR OR CONTRIBUTORS BE LIABLE FOR ANY DIRECT, INDIRECT, INCIDENTAL, SPECIAL, EXEMPLARY, OR CONSEQUENTIAL DAMAGES (INCLUDING, BUT NOT LIMITED TO, PROCUREMENT OF SUBSTITUTE GOODS OR SERVICES; LOSS OF USE, DATA, OR PROFITS; OR BUSINESS INTERRUPTION) HOWEVER CAUSED AND ON ANY THEORY OF LIABILITY, WHETHER IN CONTRACT, STRICT LIABILITY, OR TORT (INCLUDING NEGLIGENCE OR OTHERWISE) ARISING IN ANY WAY OUT OF THE USE OF THIS SOFTWARE, EVEN IF ADVISED OF THE POSSIBILITY OF SUCH DAMAGE.

(31) - ARM Ltd (arm and thumb variant targets only) - Copyright (c) 2009 ARM Ltd. All rights reserved.

Redistribution and use in source and binary forms, with or without modification, are permitted provided that the following conditions are met:

1. Redistributions of source code must retain the above copyright notice, this list of conditions and the following disclaimer.
2. Redistributions in binary form must reproduce the above copyright notice, this list of conditions and the following disclaimer in the documentation and/or other materials provided with the distribution.
3. The name of the company may not be used to endorse or promote products derived from this software without specific prior written permission.

THIS SOFTWARE IS PROVIDED BY ARM LTD ``AS IS" AND ANY EXPRESS OR IMPLIED WARRANTIES, INCLUDING, BUT NOT LIMITED TO, THE IMPLIED WARRANTIES OF MERCHANTABILITY AND FITNESS FOR A PARTICULAR PURPOSE ARE DISCLAIMED. IN NO EVENT SHALL ARM LTD BE LIABLE FOR ANY DIRECT, INDIRECT, INCIDENTAL, SPECIAL, EXEMPLARY, OR CONSEQUENTIAL DAMAGES (INCLUDING, BUT NOT LIMITED TO, PROCUREMENT OF SUBSTITUTE GOODS OR SERVICES; LOSS OF USE, DATA, OR PROFITS; OR BUSINESS INTERRUPTION) HOWEVER CAUSED AND ON ANY THEORY OF LIABILITY, WHETHER IN CONTRACT, STRICT LIABILITY, OR TORT (INCLUDING NEGLIGENCE OR OTHERWISE) ARISING IN ANY WAY OUT OF THE USE OF THIS SOFTWARE, EVEN IF ADVISED OF THE POSSIBILITY OF SUCH DAMAGE.

(32) - Xilinx, Inc. (microblaze-* and powerpc-* targets) - Copyright (c) 2004, 2009 Xilinx, Inc. All rights reserved.

Redistribution and use in source and binary forms, with or without modification, are permitted provided that the following conditions are met:

1. Redistributions source code must retain the above copyright notice, this list of conditions and the following disclaimer.
2. Redistributions in binary form must reproduce the above copyright notice, this list of conditions and the following disclaimer in the documentation and/or other materials provided with the distribution.
3. Neither the name of Xilinx nor the names of its contributors may be used to endorse or promote products

derived from this software without specific prior written permission.

THIS SOFTWARE IS PROVIDED BY THE COPYRIGHT HOLDER AND CONTRIBUTORS “AS IS” AND ANY EXPRESS OR IMPLIED WARRANTIES, INCLUDING, BUT NOT LIMITED TO, THE IMPLIED WARRANTIES OF MERCHANTABILITY AND FITNESS FOR A PARTICULAR PURPOSE ARE DISCLAIMED. IN NO EVENT SHALL THE COPYRIGHT HOLDER OR CONTRIBUTORS BE LIABLE FOR ANY DIRECT, INDIRECT, INCIDENTAL, SPECIAL, EXEMPLARY, OR CONSEQUENTIAL DAMAGES (INCLUDING, BUT NOT LIMITED TO, PROCUREMENT OF SUBSTITUTE GOODS OR SERVICES; LOSS OF USE, DATA, OR PROFITS; OR BUSINESS INTERRUPTION) HOWEVER CAUSED AND ON ANY THEORY OF LIABILITY, WHETHER IN CONTRACT, STRICT LIABILITY, OR TORT (INCLUDING NEGLIGENCE OR OTHERWISE) ARISING IN ANY WAY OUT OF THE USE OF THIS SOFTWARE, EVEN IF ADVISED OF THE POSSIBILITY OF SUCH DAMAGE.

(33) Texas Instruments Incorporated (tic6x-*, *-tirtos targets) - Copyright (c) 1996-2010,2014 Texas Instruments Incorporated. <http://www.ti.com/>

Redistribution and use in source and binary forms, with or without modification, are permitted provided that the following conditions are met:

- Redistributions of source code must retain the above copyright notice, this list of conditions and the following disclaimer.
- Redistributions in binary form must reproduce the above copyright notice, this list of conditions and the following disclaimer in the documentation and/or other materials provided with the distribution.
- Neither the name of Texas Instruments Incorporated nor the names of its contributors may be used to endorse or promote products derived from this software without specific prior written permission.

THIS SOFTWARE IS PROVIDED BY THE COPYRIGHT HOLDERS AND CONTRIBUTORS “AS IS” AND ANY EXPRESS OR IMPLIED WARRANTIES, INCLUDING, BUT NOT LIMITED TO, THE IMPLIED WARRANTIES OF MERCHANTABILITY AND FITNESS FOR A PARTICULAR PURPOSE ARE DISCLAIMED. IN NO EVENT SHALL THE COPYRIGHT OWNER OR CONTRIBUTORS BE LIABLE FOR ANY DIRECT, INDIRECT, INCIDENTAL, SPECIAL, EXEMPLARY, OR CONSEQUENTIAL DAMAGES (INCLUDING, BUT NOT LIMITED TO, PROCUREMENT OF SUBSTITUTE GOODS OR SERVICES; LOSS OF USE, DATA, OR PROFITS; OR BUSINESS INTERRUPTION) HOWEVER CAUSED AND ON ANY THEORY OF LIABILITY, WHETHER IN CONTRACT, STRICT LIABILITY, OR TORT (INCLUDING NEGLIGENCE OR OTHERWISE) ARISING IN ANY WAY OUT OF THE USE OF THIS SOFTWARE, EVEN IF ADVISED OF THE POSSIBILITY OF SUCH DAMAGE.

(34) National Semiconductor (cr16-* and crx-* targets) - Copyright (c) 2004 National Semiconductor Corporation

The authors hereby grant permission to use, copy, modify, distribute, and license this software and its documentation for any purpose, provided that existing copyright notices

are retained in all copies and that this notice is included verbatim in any distributions. No written agreement, license, or royalty fee is required for any of the authorized uses.

Modifications to this software may be copyrighted by their authors and need not follow the licensing terms described here, provided that the new terms are clearly indicated on the first page of each file where they apply.

(35) - Adapteva, Inc. (epiphany-* targets) - Copyright (c) 2011, Adapteva, Inc. All rights reserved.

Redistribution and use in source and binary forms, with or without modification, are permitted provided that the following conditions are met:

- Redistributions of source code must retain the above copyright notice, this list of conditions and the following disclaimer.
- Redistributions in binary form must reproduce the above copyright notice, this list of conditions and the following disclaimer in the documentation and/or other materials provided with the distribution.
- Neither the name of Adapteva nor the names of its contributors may be used to endorse or promote products derived from this software without specific prior written permission.

THIS SOFTWARE IS PROVIDED BY THE COPYRIGHT HOLDERS AND CONTRIBUTORS “AS IS” AND ANY EXPRESS OR IMPLIED WARRANTIES, INCLUDING, BUT NOT LIMITED TO, THE IMPLIED WARRANTIES OF MERCHANTABILITY AND FITNESS FOR A PARTICULAR PURPOSE ARE DISCLAIMED. IN NO EVENT SHALL THE COPYRIGHT HOLDER OR CONTRIBUTORS BE LIABLE FOR ANY DIRECT, INDIRECT, INCIDENTAL, SPECIAL, EXEMPLARY, OR CONSEQUENTIAL DAMAGES (INCLUDING, BUT NOT LIMITED TO, PROCUREMENT OF SUBSTITUTE GOODS OR SERVICES; LOSS OF USE, DATA, OR PROFITS; OR BUSINESS INTERRUPTION) HOWEVER CAUSED AND ON ANY THEORY OF LIABILITY, WHETHER IN CONTRACT, STRICT LIABILITY, OR TORT (INCLUDING NEGLIGENCE OR OTHERWISE) ARISING IN ANY WAY OUT OF THE USE OF THIS SOFTWARE, EVEN IF ADVISED OF THE POSSIBILITY OF SUCH DAMAGE.

(36) - Altera Corporation (nios2-* targets) - Copyright (c) 2003 Altera Corporation. All rights reserved.

Redistribution and use in source and binary forms, with or without modification, are permitted provided that the following conditions are met:

- Redistributions of source code must retain the above copyright notice, this list of conditions and the following disclaimer.
- Redistributions in binary form must reproduce the above copyright notice, this list of conditions and the following disclaimer in the documentation and/or other materials provided with the distribution.
- Neither the name of Altera Corporation nor the names of its contributors may be used to endorse or promote products derived from this software without specific prior written permission.

THIS SOFTWARE IS PROVIDED BY ALTERA CORPORATION, THE COPYRIGHT HOLDER, AND ITS CON-

TRIBUTORS "AS IS" AND ANY EXPRESS OR IMPLIED WARRANTIES, INCLUDING, BUT NOT LIMITED TO, THE IMPLIED WARRANTIES OF MERCHANTABILITY AND FITNESS FOR A PARTICULAR PURPOSE ARE DISCLAIMED. IN NO EVENT SHALL THE COPYRIGHT HOLDER OR CONTRIBUTORS BE LIABLE FOR ANY DIRECT, INDIRECT, INCIDENTAL, SPECIAL, EXEMPLARY, OR CONSEQUENTIAL DAMAGES (INCLUDING, BUT NOT LIMITED TO, PROCUREMENT OF SUBSTITUTE GOODS OR SERVICES; LOSS OF USE, DATA, OR PROFITS; OR BUSINESS INTERRUPTION) HOWEVER CAUSED AND ON ANY THEORY OF LIABILITY, WHETHER IN CONTRACT, STRICT LIABILITY, OR TORT (INCLUDING NEGLIGENCE OR OTHERWISE) ARISING IN ANY WAY OUT OF THE USE OF THIS SOFTWARE, EVEN IF ADVISED OF THE POSSIBILITY OF SUCH DAMAGE.

(37) Ed Schouten - Free BSD - Copyright (c) 2008 Ed Schouten <ed@FreeBSD.org> All rights reserved.

Redistribution and use in source and binary forms, with or without modification, are permitted provided that the following conditions are met:

1. Redistributions of source code must retain the above copyright notice, this list of conditions and the following disclaimer.
2. Redistributions in binary form must reproduce the above copyright notice, this list of conditions and the following disclaimer in the documentation and/or other materials provided with the distribution.

THIS SOFTWARE IS PROVIDED BY THE AUTHOR AND CONTRIBUTORS "AS IS" AND ANY EXPRESS OR IMPLIED WARRANTIES, INCLUDING, BUT NOT LIMITED TO, THE IMPLIED WARRANTIES OF MERCHANTABILITY AND FITNESS FOR A PARTICULAR PURPOSE ARE DISCLAIMED. IN NO EVENT SHALL THE AUTHOR OR CONTRIBUTORS BE LIABLE FOR ANY DIRECT, INDIRECT, INCIDENTAL, SPECIAL, EXEMPLARY, OR CONSEQUENTIAL DAMAGES (INCLUDING, BUT NOT LIMITED TO, PROCUREMENT OF SUBSTITUTE GOODS OR SERVICES; LOSS OF USE, DATA, OR PROFITS; OR BUSINESS INTERRUPTION) HOWEVER CAUSED AND ON ANY THEORY OF LIABILITY, WHETHER IN CONTRACT, STRICT LIABILITY, OR TORT (INCLUDING NEGLIGENCE OR OTHERWISE) ARISING IN ANY WAY OUT OF THE USE OF THIS SOFTWARE, EVEN IF ADVISED OF THE POSSIBILITY OF SUCH DAMAGE.

A 3110A Calibration Tests

GWA Worksheet Rev E

General Waveform Assessment

Used to verify the 3110A's analog signal outputs behave as expected. Use with the GWA SWG file in the Calibration directory.

General default settings

Nominal Gain = 20

Nominal DC offset = 0 VDC

Phase = 0

Interface with Chart for voltage and frequency:

Vp1 100Vp

Vp2 200Vp

Duration = 1000 msec post Trigger segment

This test assumes that the oscilloscope used can measure voltage and frequency directly, or by using scales generated on the display.

Checking the DC Voltage Output:

1. Make sure the 3110A has been on for at least 20 minutes.
2. Make sure the system gain is set to 20 and the DC offset is set such that a commanded output of 0VDC generates an output of 0V.
3. Open the GWA SWG file.
4. Set your oscilloscope to measure the V_{rms} and frequency of the signal, with an attenuation of 1X.
5. Measure the V_{rms} and frequency of the waveform.
6. Record the measured value.
7. Repeat steps 5 and 6 for the seven remaining waveforms.
8. Ensure that the measured values fall within the specified limits for frequency and amplitude.

Waveform	Start/End Amplitude, V_p	Low Limit (kHz)	Measured Frequency (kHz)	High Limit (kHz)	Low Limit (V_{rms})	Measured (V_{rms})	High Limit (V_{rms})
Sine	100	14.7		15.3	3.43		3.65
	200	14.7		15.3	6.86		7.28
Square	Start/End Amplitude, V_p	Frequency (kHz)	Measured Frequency (kHz)	High Limit (kHz)	Low Limit (V_{rms})	Measured (V_{rms})	High Limit (V_{rms})
	100	14.7		15.3	4.75		5.25
	200	14.7		15.3	9.50		10.50
Triangle	Start/End Amplitude, V_p	Frequency (kHz)	Measured Frequency (kHz)	High Limit (kHz)	Low Limit (V_{rms})	Measured (V_{rms})	High Limit (V_{rms})
	100	14.7		15.3	2.77		3.00
	200	14.7		15.3	5.54		6.00
Sawtooth	Start/End Amplitude, V_p	Frequency (kHz)	Measured Frequency (kHz)	High Limit (kHz)	Low Limit (V_{rms})	Measured (V_{rms})	High Limit (V_{rms})
	100	14.7		15.3	2.74		3.03
	200	14.7		15.3	5.49		6.06

RFA Worksheet Rev G

Ripple Frequency Accuracy

Used to determine the frequency accuracy of the 3110A's ripple waveform type. Use with RFA SWG files in the Calibration directory.

General default settings

Nominal Gain = 20

Phase = 0

Interface Chart voltage amplitude:

50 kHz 50 Vp BNC output = 2.5 Vp

100 kHz 50 Vp BNC output = 2.5 Vp

500 kHz 50 Vp BNC output = 2.3 Vp

1 MHz 50 Vp BNC output = 1.7 Vp

Duration = 1000 sec

This test assumes that the oscilloscope used can measure frequency directly. If required due to equipment limitations, the period duration (T) can be measured, and frequency calculated ($F=1/T$).

Checking the Frequency Accuracy:

1. Make sure the 3110A has been on for at least 20 minutes.
2. Open the RFA SWG file.
3. Measure the frequency of the waveform. Ensure that between three and five complete cycles are visible, and that the waveform takes up as much of the vertical (amplitude) axis as possible.
4. Record the measured frequency in the table.
5. Repeat steps 3 and 4 for the remaining frequencies.
6. Ensure that the measured frequencies are within the specified limits.

Test Frequency	Lower Frequency Limit	Measured Frequency	Upper Frequency Limit
50 kHz	49 kHz		51 kHz
100 kHz	99 kHz		101 kHz
500 kHz	495 kHz		505 kHz
1 MHz	0.99 MHz		1.01 MHz

RVRT Rev H

Ripple Voltage Response Test

Used to determine how close the 3110A's ripple generator's amplitude is to the expected response. Use with RVRT SWG files in the Calibration directory.

General default settings

Gain = 20

Phase = 0

Frequency varies.

NOTE: All voltage values are in Vpp.

Interface Chart voltage amplitude, as indicated in the data table below:

10 Vpp BNC output = 0.5 Vp-p

150 Vpp BNC output = 7.5 Vp-p

Duration = 1000 sec

This test assumes that the oscilloscope used can measure voltage directly. If desired the amplitude can be measured and peak-to-peak values calculated.

Checking the Voltage Response:

1. Make sure the 3110A has been on for at least 20 minutes.
2. Adjust the DC offset and Gain in the Settings/System Calibration tab for nominal 0 VDC offset and actual output gain = 20.
3. Begin the waveform and measure the amplitude of the waveform in Vrms.
4. Record the maximum and minimum voltages observed.
5. Repeat steps 4-6 for the remaining trials.
6. Calculate the average value using the measured maximum and minimum values.
7. Ensure that the calculated average values for amplitude fall within the specified upper and lower limits.

RVRT Rev H

	GUI 10 V _{pp}	BNC 0.50 V _{pp}	Nominal = 0.177 V _{rms}		
Frequency (Hz)	Range	Measured	Average	Lower Limit	Upper Limit
100	Max Voltage			0.156	0.198
	Min Voltage				
100000	Max Voltage			0.156	0.198
	Min Voltage				
1000000	Max Voltage			0.115	0.146
	Min Voltage				

	GUI 150 V _{pp}	BNC 7.50 V _{pp}	Nominal = 2.65 V _{rms}		
Frequency (Hz)	Range	Measured	Average	Lower Limit	Upper Limit
100	Max Voltage			2.49	2.81
	Min Voltage				
100000	Max Voltage			2.49	2.81
	Min Voltage				
1000000	Max Voltage			1.76	1.99
	Min Voltage				

RPFT Worksheet Rev A

Ripple Phase Functional Test

Used to determine if the phase shift function of the 3110A is working as intended. Use with RPFT SWG file in the calibration directory.

General default settings

Gain = 20

Interface Chart voltage amplitude = 100 Vp, or BNC output = 5 Vp

Duration = 1000 sec

This test is designed to verify that the phase shift feature is functioning, it will not verify the accuracy of this feature. For accuracy verification, refer to the RPA test.

Checking the Phase Accuracy Procedure:

1. Make sure the 3110A has been on for at least 20 minutes.
2. Open the RPFT SWG file.
3. Set oscilloscope to trigger once, at a level that will allow viewing from the start of waveform playback, shown in Figure 1.
4. Verify that playback of the first segment matches Figure 1, in which the sine wave output starts at 0V.
 - a. If the output is dissimilar to figure 1 in terms of waveform start value, the device will fail the RPFT.
5. Verify that playback of the second segment matches Figure 2, in which the sine wave output starts at 0V but immediately goes negative (phase shift of 180°).
 - a. If the output is dissimilar to figure 2 in terms of waveform start value, the device will fail the RPFT.

0° (Pass/Fail)	180° (Pass/Fail)

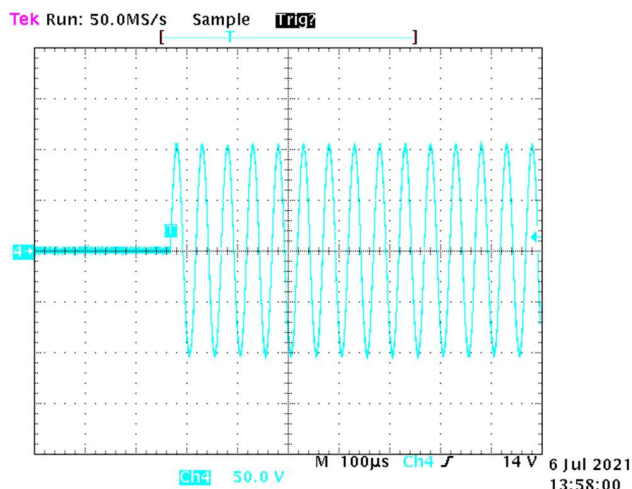

Figure 1

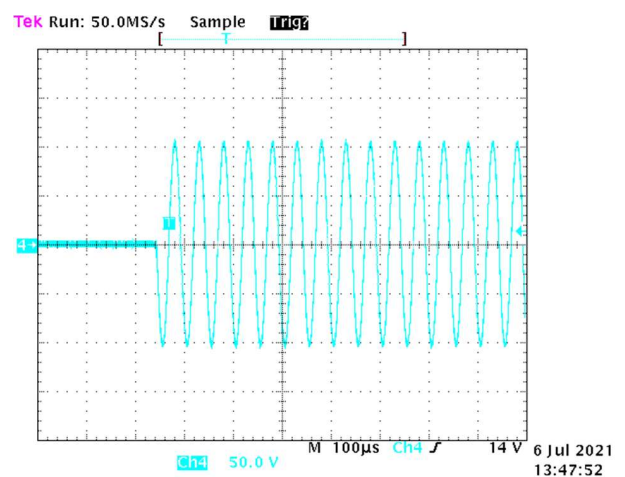

Figure 2

DC Worksheet Rev E

DC Voltage Accuracy

Used to determine the DC voltage output and compare to the commanded value. Use with DC SWG files in the Calibration directory. All transitions are from 0 VDC to a second DC voltage.

General default settings

Nominal Gain = 20

Nominal DC offset = 0 VDC

Phase = 0

Default three segment with trigger

Interface Chart voltage amplitude:

DC1 0 VDC to 13.5 VDC

DC2 0 VDC to 150 VDC

Duration = 1000 sec after trigger segment

A digital multimeter should be used for this portion of the testing.

Checking the DC Voltage Output:

1. Make sure the 3110A has been on for at least 20 minutes.
2. Make sure the system gain is set to 20 and the DC offset is set such that a 0V commanded output measures 0V.
3. Open the DC SWG file.
4. Use the digital multimeter to measure the DC voltage at the 3110A's output and begin waveform playback.
5. Measure the first DC voltage.
6. Record the measured value.
7. Repeat steps 5 and 6 for the remaining two trials to account for any variance in the output or measurement device.
8. Calculate the average of all three trials and record this in the "Average" field.
9. If both average values fall within the maximum and minimum limits, the unit will PASS. Otherwise, the unit will FAIL.

Trial No.	Voltage	
	DC1 (0.675 VDC)	DC2 (7.50 VDC)
1		
2		
3		
Max Limit	0.6885	7.65
Average:		
Min Limit	0.6615	7.35

RT Worksheet Rev D

Rise Time Frequency Accuracy

Used to determine the time for the 3110A to transition between two DC voltage states. Use with RT SWG files in the Calibration directory. All transitions are from one DC voltage to a second DC voltage.

General default settings

Nominal Gain = 20

Phase = 0

Default two-segment with Trigger

Interface Chart voltage amplitude:

RT1 0 VDC to 10 VDC

RT2 -150 VDC to 150 VDC

Duration = 100 msec per segment

This test assumes that the oscilloscope used can measure time directly, or by using scales generated on the display. Measuring the time manually will also achieve the desired result. An example of the area to be measured is displayed in the oscilloscope shot below.

The rise time is defined as the period from 10% of the transition voltage to 90% of the transition voltage; A total of 80% ΔV.

Checking the Rise Time:

1. Make sure the 3110A has been on for at least 20 minutes.
2. Open the RT SWG file.
3. Set scope to capture the transition, using a single rising-edge trigger.
4. Measure time to complete the transition.
5. Record in the table below.
6. Repeat steps 2-5 to complete three total trials.
7. Calculate the average of all three trials and ensure that the calculated average is less than the 1us limit specified.

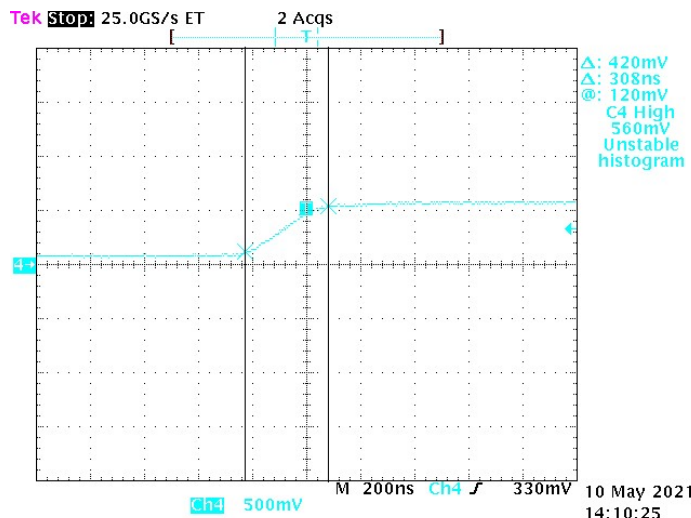

Trial No.	Rise Time	
	RT1	RT2
1		
2		
3		
Average:		
Limit:	< 1 μsec	< 1 μsec

SD Worksheet Rev D

Minimum Step Duration Measurement

Used to determine the accuracy of timed voltage states, or how accurately the 3110A can output a signal for a set time. All transitions are from one DC voltage to a second DC voltage, then a return to the first voltage.

General default settings

- Gain = 20
- Phase = 0
- Default three-segment with Trigger
- Interface Chart voltage amplitude:
 - SD1 0 VDC to 10 VDC, back to 0 VDC
 - SD2 0 VDC to 100 VDC, back to 0 VDC
 - SD3 0 VD to 200 VDC, back to 0 VDC
- Duration = 25 µsec per transition segment

This test assumes that the oscilloscope used can measure time directly, or by using scales generated on the display. Time measurements can be done manually if preferred, this will achieve the desired result.

Checking the Rise Time:

1. Make sure the 3110A has been on for at least 20 minutes.
2. Set the oscilloscope to capture an area which contains the rise, steady-state duration, and fall. Using a single-shot rising-edge trigger produces the best results.
3. Measure the duration of the steady-state higher voltage as indicated in the figure below.
4. Record the measured value.
5. Repeat steps 2-4 for a total of three trials.
6. Calculate the average of all three trials, and record this in the final row.
7. Ensure that the calculated average falls within the specified limits.

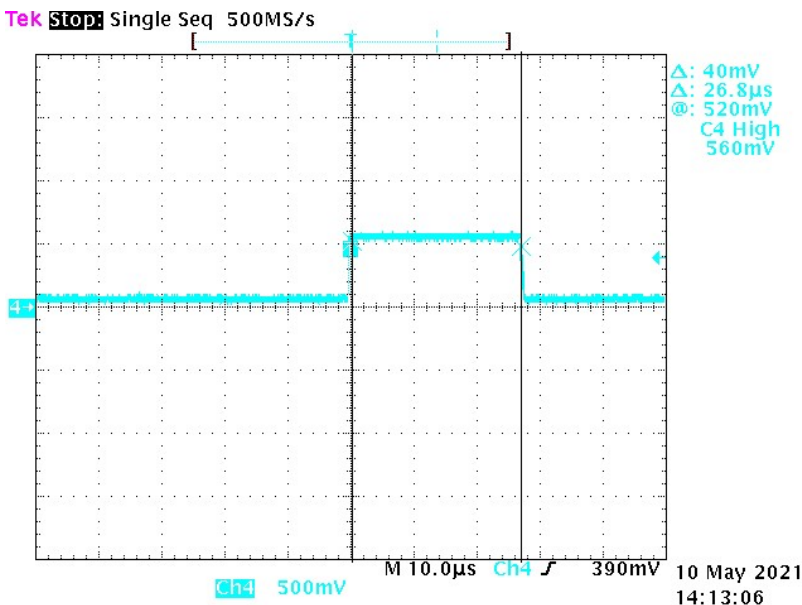

Step Duration Times			
Trial No.	SD1	SD2	SD3
1			
2			
3			
Average:			
Limit:	± 3 µsec	± 3 µsec	± 3 µsec

ORAT Worksheet Rev E

Offset Ripple Accuracy Test

Used to determine the accuracy of the ripple waveform while also providing a DC offset. Use with ORAT SWG files in the Calibration directory.

General default settings

Nominal Gain = 20

Nominal DC offset = 0 VDC (DC offset in system gain, refer to section 3.1 of Owner’s Manual)

Phase = 0

This test assumes that the oscilloscope used can measure voltage directly, or by using scales generated on the display. A digital multimeter will also be used for measuring the DC offset of the waveform.

Checking the offset ripple:

1. Make sure the 3110A has been on for at least 20 minutes.
2. Make sure the system gain is set to 20 and the DC offset is set such that a commanded output of 0V generates an output of 0V.
3. Open the ORAT SWG file.
4. Set the scope to measure the frequency and Vrms of the output with an attenuation of 1X. Set the scope for AC coupling.
5. Begin waveform playback.
6. Measure the amplitude of the ripple.
7. Connect the output of the 3110A to a DMM.
8. Record the measured offset of the output.
9. Repeat steps 6 and 7 for the 10Vpp trial.
10. Ensure that the measured Ripple Amplitude and Offset values are within the specified limits.

	Lower Limit (V _{rms})	Measured Ripple Amplitude	Upper Limit (V _{rms})	Offset Lower Limit (VDC)	Measured DC Offset	Offset Upper Limit (VDC)
1Vp Ripple	0.032		0.039	0.6075		0.7425
100Vp Ripple	3.18		3.89	4.5		5.5

Ripple Phase Accuracy

Used to determine how close the 3110A’s phase shift is to the commanded value. Use with RPA SWG files in the Calibration directory. This test will only be used in the event that precise phase shifting is necessary, this test is not performed as part of the factory calibration procedure.

General default settings

Gain = 20
 Interface Chart voltage amplitude = 100 V_p, or BNC output = 5 V_p
 Duration = 1000 sec

One of the simplest ways to measure phase is to observe the time shift generated by a phase change. The change in phase changes places where the wave equals zero and can be measured with an oscilloscope. Figure 2 shows an example of a phase shift. For a given *n* and phase shift ϕ , the time from *n* = 0 to the *n*th crossing is given by

$$t = \frac{1}{2\pi f}(n\pi - \phi); \phi \text{ in radians and } n = 1, 2, 3, \dots$$

or

$$t = \frac{1}{2f}\left(n - \frac{\phi}{180}\right); \phi \text{ in degrees and } n = 1, 2, 3, \dots$$

The error can be found from

$$\%error = \frac{|t_m - t_{exp}|}{t_m} * 100$$

Where *t_m* is the time measured and *t_{exp}* is the expected time, which are the values in the table on the next page.

Checking the Phase Accuracy Procedure:

1. Make sure the 3110A has been on for at least 20 minutes.
2. Open the RPA SWG file.
3. Set oscilloscope to a single trigger, causing the scope to trigger once such that you get an image similar to Figure 1.
4. Once you have the desired viewing window, measure the time from the beginning of the curve to each of the zero crossing points.
 - a. Note: Only 4 zero-crossing points will be recorded. n=4, 5, 6, and 7
5. Record the measured times of zero crossing points and repeat for the remaining waveforms.

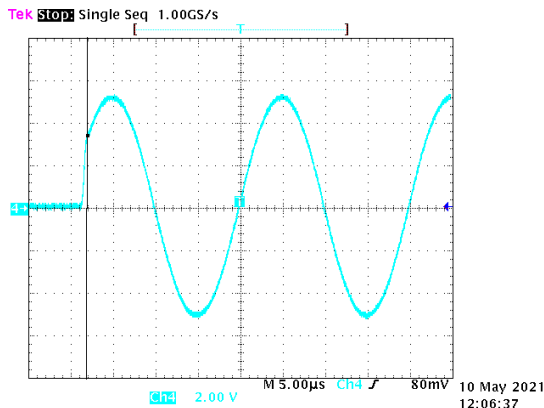

Figure 1 Example Oscilloscope Reading

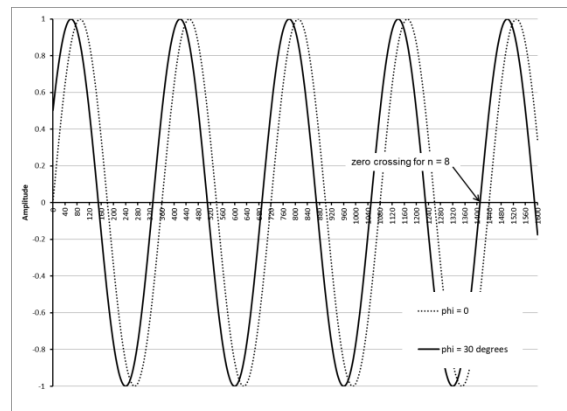

Figure 2 for $\phi = 30^\circ$

RPA1: 50 kHz $\phi = 30^\circ$

zeros (crossing) n =	time (μ sec)	measured (μ sec)	Variation %
4	38.33		
5	48.33		
6	58.33		
7	68.33		
		Average Limit	0.5 %

RPA 2: 500 kHz $\phi = 30^\circ$

zeros (crossing) n =	time (μ sec)	measured (μ sec)	Variation %
4	3.833		
5	4.833		
6	5.833		
7	6.833		
		Average Limit	2 %

RPA2: 50 kHz $\phi = 75^\circ$

zeros (crossing) n =	time (μ sec)	measured (μ sec)	Variation %
4	35.833		
5	45.833		
6	55.833		
7	65.833		
		Average Limit	0.5 %

RPA4: 500 kHz $\phi = 75^\circ$

zeros (crossing) n =	time (μ sec)	measured (μ sec)	Variation %
4	3.5833		
5	4.5833		
6	5.5833		
7	6.5833		
		Average Limit	3 %



T1000 Transformer

for Magnetic-Field Susceptibility Testing

Features

- Up to 100 A_{RMS} secondary current
- Exceeds AF Magnetic Field test requirements of DO 160 Section 19 and Boeing D6-16050-5 Section 7.2
- Circuit breaker protected from over-current
- Durable steel and high-density polyethylene case for impact resistance

Application

The AE Techron T1000 Magnetic-Field Susceptibility Transformer was designed to exceed the AF Magnetic Field susceptibility test requirements of DO 160 Section 19 and Boeing D6-16050-5 Section 7.2.

It may also be used as 10-to-1 step-down transformer for output currents of up to 100 A_{RMS}.

Description

The T1000 transformer provides up to 300 A-m and is able to generate up to 100A_{RMS}. The turns ratio provides a ten-to-one step down to the secondary winding.

The T1000 provides convenient input connectors via binding posts. Standard 0.75-inch spacing of binding posts allows use of standard plugs. Output is via 150A feed-through terminal block connectors. The connectors accept up to 1/0 AWG wire.

A 12-amp circuit breaker protects the unit against over-current conditions. A rugged, impact-resistant case and robust design protects the transformer from accidental damage.

The T1000 transformer is for use by experienced staff.

Unit Setup

Safety First

Throughout these instructions, special emphasis is placed on good safety practices. The LIGHTNING FLASH and EXCLAMATION POINT graphics are used to highlight certain topics that require extra precaution.

Watch for These Symbols:



The lightning flash with the arrowhead symbol within an equilateral triangle is intended to alert the user to the presence of “danger-

ous voltage” inside the product that may constitute a risk of electric shock.



The exclamation point within an equilateral triangle is intended to alert the user to the presence of important operating and maintenance instructions in the literature accompanying the product.

Important Safety Instructions

1. Read and keep these instructions. Follow all instructions and heed all warnings.

2. Do not use this apparatus near water. To reduce the risk of fire or electric shock, do not expose this apparatus to rain or moisture. Do not expose this equipment to dripping or splashing and ensure that no objects filled with liquids, such as vases, are placed on the equipment.



3. Disconnect this product from all sources of electrical power before cleaning. Use a damp cloth for cleaning. Clean the outside of the product only.



4. Care should be taken so that objects do not fall into the product.

5. Do not block any ventilation openings. Install in accordance with the manufacturer’s instructions.

6. Do not install near any heat sources such as radiators, heat registers, stoves, or other apparatus (including amplifiers) that produce heat.

7. Only use attachments/accessories specified by the manufacturer.

8. Refer all servicing to qualified service personnel. Servicing is required when the apparatus has been damaged in any way, such as liquid has been spilled or objects have fallen into the apparatus, the apparatus



has been exposed to rain or moisture, does not operate normally, or has been dropped.

9. Do not remove product covers. No user serviceable parts inside. Refer servicing to qualified service personnel.

10. Always use the appropriate wire size and insulator for maximum voltage and current expected.

11. Operating conditions: 10°C to 40°C; Humidity: 70% or less, non-condensing.

Unpacking

Carefully unpack and inspect the unit. Please note any damage for future reference and notify the shipping company immediately if damage is found. Also, please save the shipping carton and materials as evidence of damage and/or for returning the unit for repair.

Connecting the T1000 Transformer (see Figure 1)

1. Before connecting the T1000, make sure all equipment you are connecting is disconnected from AC power.

2. Connect from a power amplifier, another power source, or a simulated load to your equipment under test.

3. Connect from a power amplifier to the T1000 4-way binding post input connectors. Connection can be made with cables terminated with spade lugs, banana plugs, pin connectors or bare wire.

4. Create a cable using AWG 3 to 1/0 wire. Connect from the T1000 output connectors to the radiating wire loop.

Equipment Maintenance

 To prevent electric shock, do not remove product covers. No

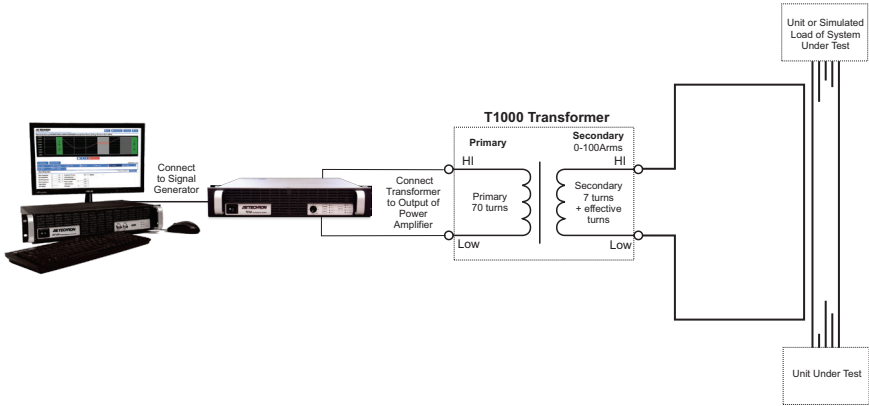

Figure 1 – DO 160 Section 19 Test Load Wiring

user serviceable parts inside. Internal fuses should only be replaced by a service technician. Refer all servicing to qualified service personnel.

Disconnect this product before cleaning. Use a damp cloth for cleaning. Clean the outside of the product only.

Factory Service

If the unit fails to perform, it may need to be returned for Factory Service. All units under warranty will be serviced free of charge (customer is responsible for one-way shipping charges as well as any custom fees, duties, and/or taxes). Please review the Warranty included with this Instruction Sheet for more information.

All service units must be given Return Authorization by AE Techron, Inc. before being returned. Return Authorizations can be requested on our website or by contacting our Customer Service Department.

Please take extra care when packaging your unit for repair. It should be returned in its original packaging or a suitable alternative. Replacement packaging materials can be purchased for a nominal

fee.

Please send all service units to the following address and be sure to include your Return Authorization Number on the box.

AE Techron, Inc.
Attn: Service Department / RMA#
2507 Warren Street
Elkhart, IN 46516

Specifications

Performance Specifications

Primary:

200 V_P maximum input

Secondary:

20.0 V_P maximum output

Dielectric Test:

1200 VDC

Turns Ratio:

Ten-to-one step down

Protection:

Input power-protected via circuit breaker

Controls and Connectors

(see Figure 2)

Input Terminals:

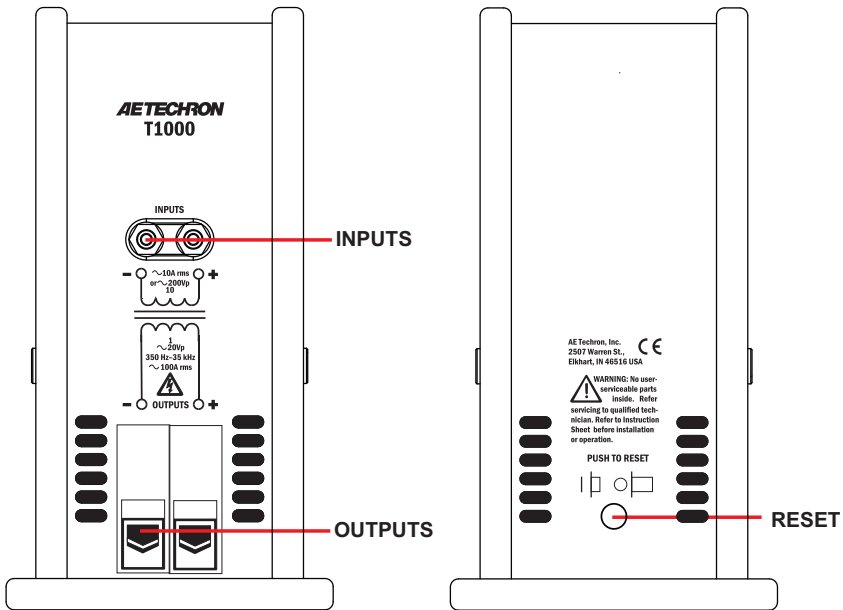

Figure 2 – T1000 Controls and Connectors

4-way binding posts

Output Terminals:

Feed-through terminal block (150A)

Circuit Breaker:

Primary input limited to 12A via circuit breaker; push to reset

Physical Characteristics

Case:

Steel interior shell with a durable external shell made from high-density polyethylene for impact resistance.

Operating Conditions,

Temperature: 10°C to 40°C (50°F to 104°F)

Humidity: 70% or less, non-condensing

Recommended Ambient Temperature:

25°C (77°F)

Cooling:

Natural air convection

Weight:

15 lbs. (6.8 kg)

Dimensions (HxWxD):

9.75 in. x 5.25 in. x 10.375 in. (24.8 cm x 13.3 cm x 26.4 cm)

Additional Product Information

This manual does not include all of the details of design, production, or variations of the equipment. Nor does it cover every possible situation which may arise during installation, operation or maintenance.

Additional information may be included with your unit via digital media and is also available at the AE Techron website at www.aetechron.com.

Information Accuracy

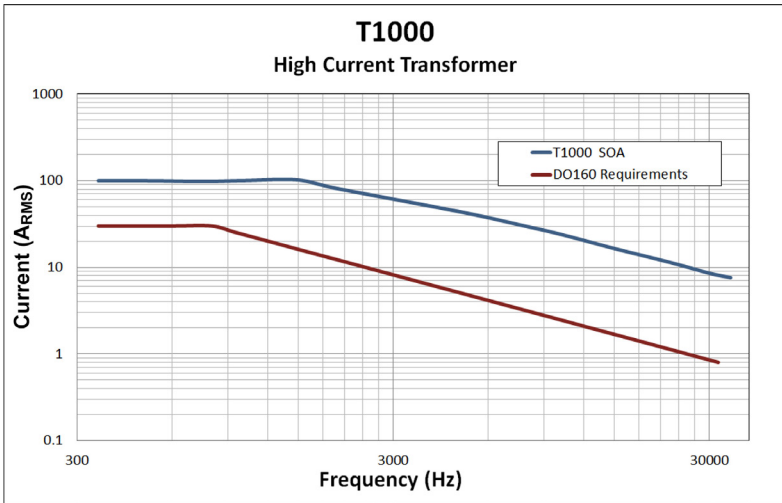

Figure 3 – T1000 Maximum SOA (safe operating area)

The information provided in this manual was deemed accurate as of the publication date. However, updates to this information may have occurred. To obtain the latest information for your unit, please visit the AE Techron website at www.aetechron.com.

AE Techron is a registered trademark of AE Techron, Inc. Other trademarks are the property of their respective owners.

Trademark Notice

Three-Year, No-Fault Warranty

SUMMARY OF WARRANTY

AE TECHRON INC., of Elkhart, Indiana (Warrantor) warrants to you, the ORIGINAL COMMERCIAL PURCHASER and ANY SUBSEQUENT OWNER of each NEW **AE TECHRON INC. product**, *for a period of three (3) years from the date of purchase, by the original purchaser (warranty period) that the product is free of defects in materials and workmanship and will meet or exceed all advertised specifications for such a product. We further warrant the new AE Techron product regardless of the reason for failure, except as excluded in the Warranty.*

ITEMS EXCLUDED FROM WARRANTY

This AE Techron Warranty is in effect only for failure of a new AE Techron product which occurred within the Warranty Period. It does not cover any product which has been damaged because of any intentional misuse, or loss which is covered under any of your insurance contracts. This warranty does not extend to any product on which the serial number has been defaced, altered, or removed. It does not cover damage to loads or any other products or accessories resulting from **AE TECHRON INC.** product failure. It does not cover

defects or damage caused by the use of unauthorized modifications, accessories, parts, or service.

WHAT WE WILL DO

We will remedy any defect, regardless of the reason for failure (except as excluded), by repair or replacement, at our sole discretion. Warranty work can only be performed at our authorized service centers or at our factory.

Expenses in remedying the defect will be borne by **AE TECHRON INC.**, including one-way surface freight shipping costs within the United States. (Purchaser must bear the expense of shipping the product between any foreign country and the port of entry in the United States and all taxes, duties, and other customs fees for such foreign shipments.

HOW TO OBTAIN WARRANTY SERVICE

When you notify us of your need for warranty service, we will give you an authorization to return the product for service. All components must be shipped in a factory pack or equivalent which, if needed, may be obtained from us for a nominal charge. We will take corrective actions within a reasonable time of the date of receipt of the defective product. If the repairs made by us are not satisfactory, notify us immediately.

DISCLAIMER OF CONSEQUENTIAL AND INCIDENTAL DAMAGES

You are not entitled to recover from us any consequential or incidental damages resulting from any defect in our product. This includes any damage to another product or products resulting from such a defect.

WARRANTY ALTERATIONS

No person has the authority to enlarge, amend, or modify this warranty. The warranty is not extended by the length of time for which you are deprived of the use of this product. Repairs and replacement parts provided under the terms of this warranty shall carry only the unexpired portion of this warranty.

DESIGN CHANGES

We reserve the right to change the design of any product from time to time without notice and with no obligation to make corresponding changes in products previously manufactured.

LEGAL REMEDIES OF PURCHASER

There is no warranty that extends beyond the terms hereof. This written warranty is given in lieu of any oral or implied warranties not contained herein. We disclaim all implied warranties, including, without limitation, any warranties of merchantability or fitness for a particular purpose. No action to enforce this Warranty shall be commenced later than ninety (90) days after expiration of the warranty period. This statement of warranty supersedes any others contained in this manual for AE Techron products.

AE Techron, Inc.

Customer Service Department
2507 Warren Street
Elkhart, IN 46516
U.S.A.
574.295.9495
www.aetechron.com



T2000 Transformer

for Low-Frequency Conducted Susceptibility Testing

Features

- Frequency response – 10 Hz to 250 kHz
- Turns ratio – 2:1 step down
- Audio power – 200W
- Meets the LF Conducted Susceptibility test requirements of DO 160 Section 18
- Circuit breaker protected from over-current on secondary
- Durable steel and high-density polyethylene case for impact resistance

Application

The AE Techron T2000 Audio-Bandwidth Transformer was designed to meet or exceed the LF conducted susceptibility test requirements of DO 160 Section 18. The T2000 is used to apply the required test signals to the lines under test for ripple voltage tests and continuous or transient conducted immunity tests.

It may also be used as a 2-to-1 step-down transformer. The secondary can support up to 40 A_P.

Description

The T2000 transformer supports up to 200W and is able to pass up to 40A_P on the secondary. The turns ratio provides a two-to-one step down.

The T2000 provides convenient input connectors via binding posts. Standard 0.75-inch spacing of binding posts allows use of standard plugs. Output is via feed-through terminal block connectors (76A); accepts up to AWG 6 wire.

A thermal breaker protects the unit against over-current conditions on the primary. A 35A_{RMS} breaker protects the unit against over-current conditions on the secondary. A rugged, impact-resistant case and robust design protects the transformer from accidental damage.

The T2000 transformer is for use by experienced staff.

Unit Setup

Safety First

Throughout these instructions, special emphasis is placed on good safety practices. The LIGHTNING FLASH and EXCLAMATION POINT graphics are used to highlight certain topics that require extra precaution.

Watch for These Symbols:



The lightning flash with the arrowhead symbol within an equilateral triangle is intended to alert

the user to the presence of “dangerous voltage” inside the product that may constitute a risk of electric shock.



The exclamation point within an equilateral triangle is intended to alert the user to the presence of important operating and maintenance instructions in the literature accompanying the product.

Important Safety Instructions

1. Read and keep these instructions. Follow all instructions and heed all warnings.



2. Do not use this apparatus near water. To reduce the risk of fire or electric shock, do not expose this apparatus to rain or moisture. Do not expose this equipment to dripping or splashing and ensure that no objects filled with liquids, such as vases, are placed on the equipment.



3. Disconnect this product from all sources of electrical power before cleaning. Use a damp cloth for cleaning. Clean the outside of the product only.

4. Care should be taken so that objects do not fall into the product.

5. Do not block any ventilation openings. Install in accordance with the manufacturer’s instructions.

6. Do not install near any heat sources such as radiators, heat registers, stoves, or other apparatus (including amplifiers) that produce heat.

7. Only use attachments/accessories specified by the manufacturer.



8. Refer all servicing to qualified service personnel. Servicing is required when the apparatus has been damaged in any way, such as liquid has been spilled or objects have fallen into the apparatus, the apparatus

has been exposed to rain or moisture, does not operate normally, or has been dropped.

9. Do not remove product covers.

No user serviceable parts inside.

Refer servicing to qualified service personnel.

10. Always use the appropriate wire size and insulator for maximum voltage and current expected.

11. Operating conditions: 10°C to 40°C; Humidity: 70% or less, non-condensing.

Unpacking

Carefully unpack and inspect the unit. Please note any damage for future reference and notify the shipping company immediately if damage is found. Also, please save the shipping carton and materials as evidence of damage and/or for returning the unit for repair.

Connecting the T2000

Transformer (see Figure 1)

1. Before connecting the T2000, make sure all equipment you are connecting is disconnected from AC power.

2. Connect from a power amplifier, another power source, or a simulated load to your equipment under test.

3. Connect from a power amplifier to the T2000 4-way binding post input connectors. Connection can be made with cables terminated with spade lugs, pin connectors or bare wire.

4. Create output cables using up to AWG 6 wire. Connect from the T2000 output connectors as shown in Figure 1.

Equipment Maintenance

To prevent electric shock, do not



remove product covers. No user serviceable parts inside. Internal

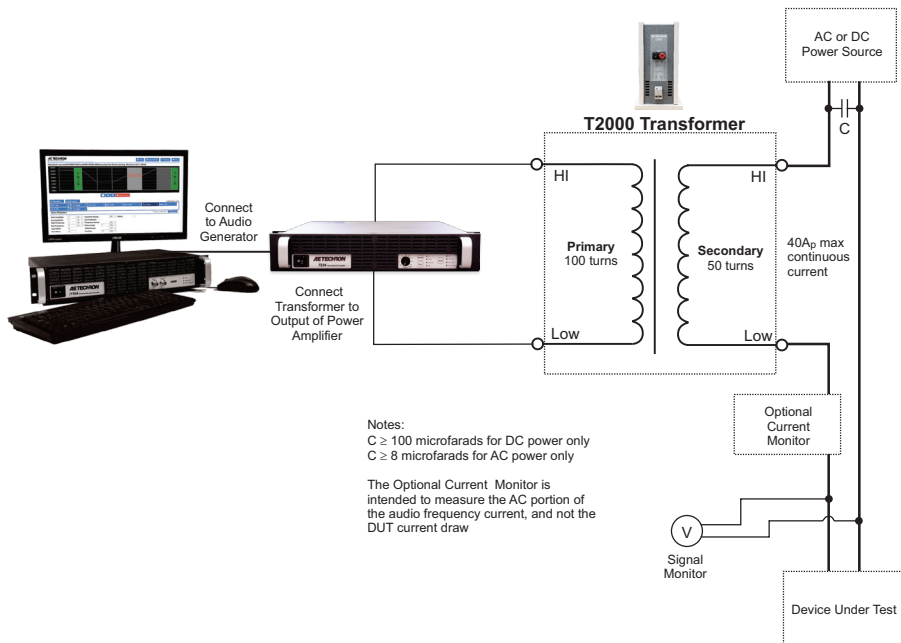

**Figure 1 – DO 160 Section 18 Test Setup
(for AC and DC power lines, differential mode)**

fuses should only be replaced by a service technician. Refer all servicing to qualified service personnel.

Disconnect this product before cleaning. Use a damp cloth for cleaning. Clean the outside of the product only.

Factory Service

If the unit fails to perform, it may need to be returned for Factory Service. All units under warranty will be serviced free of charge (customer is responsible for one-way shipping charges as well as any custom fees, duties, and/or taxes). Please review the Warranty included with this Instruction Sheet for more information.

All service units must be given Return Authorization by AE Techron, Inc. before being returned. Return Authorizations

can be requested on our website or by contacting our Customer Service Department.

Please take extra care when packaging your unit for repair. It should be returned in its original packaging or a suitable alternative. Replacement packaging materials can be purchased for a nominal fee.

Please send all service units to the following address and be sure to include your Return Authorization Number on the box.

AE Techron, Inc.
Attn: Service Department / RMA#
2507 Warren Street
Elkhart, IN 46516

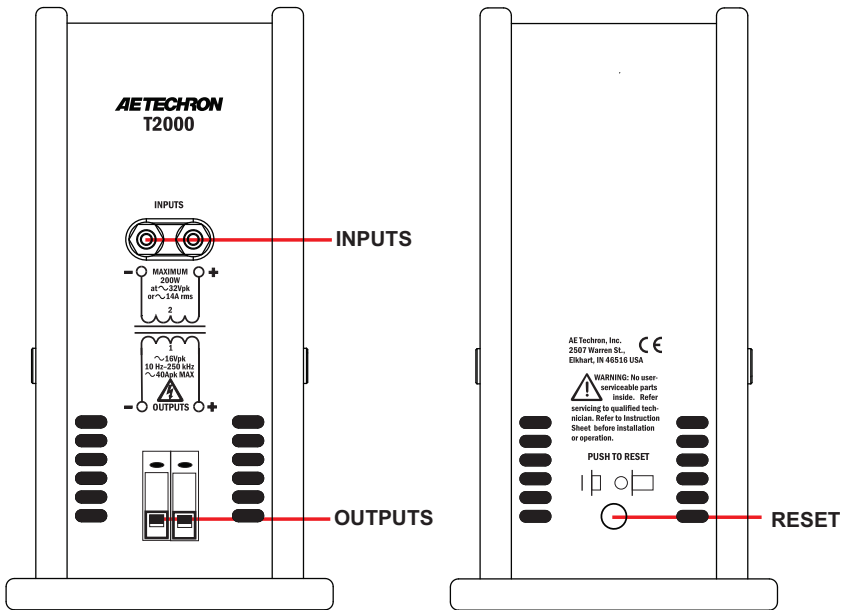

Figure 2 – T2000 Controls and Connectors

Specifications

Performance Specifications

Transformer DC Resistance,

Primary:

0.076 ohms

Secondary:

0.021 ohms

Frequency Response:

10 Hz to 250 kHz

Audio Power:

200W

Dielectric Test:

1500 VDC primary to secondary

Secondary Saturation:

40A_P AC or DC maximum

Turns Ratio:

Two-to-one step down

Secondary Inductance:

Approximately 0.6 mH (unloaded)

Protection:

Input power-protected via thermal breaker; secondary winding protected via 35A_{RMS} breaker

Controls and Connectors

(see Figure 2)

Input Terminals:

4-way binding posts

Output Terminals:

Feed-through terminal block (76A); accepts up to AWG 6 wire

Circuit Breaker:

Secondary winding limited to 35A_{RMS} via circuit breaker; push to reset

Physical Characteristics

Case:

Steel interior shell with a durable external shell made from high-density polyethylene for impact resistance.

Operating Conditions,

Temperature: 10°C to 40°C (50°F to 104°F)

Humidity: 70% or less, non-condensing

Recommended Ambient Temperature: 25°C (77°F)

Cooling:

Natural air convection

Weight:

17 lbs. (7.7 kg)

Dimensions (WxDxH):

5.25 in. x 10.375 in. x 9.75 in. (13.3 cm x 26.4 cm x 24.8 cm)

Additional Product Information

This manual does not include all of the details of design, production, or variations of the equipment. Nor does it cover every possible situation which may arise

during installation, operation or maintenance.

Additional information may be included with your unit via digital media and is also available at the AE Techron website at www.aetechron.com.

Information Accuracy

The information provided in this manual was deemed accurate as of the publication date. However, updates to this information may have occurred. To obtain the latest information for your unit, please visit the AE Techron website at www.aetechron.com.

Trademark Notice

AE Techron is a registered trademark of AE Techron, Inc. Other trademarks are the property of their respective owners.

Three-Year, No-Fault Warranty

SUMMARY OF WARRANTY

AE TECHRON INC., of Elkhart, Indiana (Warrantor) warrants to you, the ORIGINAL COMMERCIAL PURCHASER and ANY SUBSEQUENT OWNER of each NEW **AE TECHRON INC. product**, *for a period of three (3) years from the date of purchase, by the original purchaser (warranty period) that the product is free of defects in materials and workmanship and will meet or exceed all advertised specifications for such a product. We further warrant the new AE Techron product regardless of the reason for failure, except as excluded in the Warranty.*

ITEMS EXCLUDED FROM WARRANTY

This AE Techron Warranty is in effect only for failure of a new AE Techron product which occurred within the Warranty Period. It does not cover any product which has been damaged because of any intentional misuse, or loss which is covered under any of your insurance contracts. This warranty does not extend to any product on which the serial number has been defaced, altered, or removed. It does not cover damage to loads or any other products or accessories resulting from **AE TECHRON INC.** product failure. It does not cover

defects or damage caused by the use of unauthorized modifications, accessories, parts, or service.

WHAT WE WILL DO

We will remedy any defect, regardless of the reason for failure (except as excluded), by repair or replacement, at our sole discretion. Warranty work can only be performed at our authorized service centers or at our factory.

Expenses in remedying the defect will be borne by **AE TECHRON INC.**, including one-way surface freight shipping costs within the United States. (Purchaser must bear the expense of shipping the product between any foreign country and the port of entry in the United States and all taxes, duties, and other customs fees for such foreign shipments.

HOW TO OBTAIN WARRANTY SERVICE

When you notify us of your need for warranty service, we will give you an authorization to return the product for service. All components must be shipped in a factory pack or equivalent which, if needed, may be obtained from us for a nominal charge. We will take corrective actions within a reasonable time of the date of receipt of the defective product. If the repairs made by us are not satisfactory, notify us immediately.

DISCLAIMER OF CONSEQUENTIAL AND INCIDENTAL DAMAGES

You are not entitled to recover from us any consequential or incidental damages resulting from any defect in our product. This includes any damage to another product or products resulting from such a defect.

WARRANTY ALTERATIONS

No person has the authority to enlarge, amend, or modify this warranty. The warranty is not extended by the length of time for which you are deprived of the use of this product. Repairs and replacement parts provided under the terms of this warranty shall carry only the unexpired portion of this warranty.

DESIGN CHANGES

We reserve the right to change the design of any product from time to time without notice and with no obligation to make corresponding changes in products previously manufactured.

LEGAL REMEDIES OF PURCHASER

There is no warranty that extends beyond the terms hereof. This written warranty is given in lieu of any oral or implied warranties not contained herein. We disclaim all implied warranties, including, without limitation, any warranties of merchantability or fitness for a particular purpose. No action to enforce this Warranty shall be commenced later than ninety (90) days after expiration of the warranty period. This statement of warranty supersedes any others contained in this manual for AE Techron products.

AE Techron, Inc.

Customer Service Department
2507 Warren Street
Elkhart, IN 46516
U.S.A.
574.295.9495
www.aetechron.com



T3700 Transformer

for Electric-Field Susceptibility Testing

Features

- Up to 3,700 V_{RMS}
- Meets or exceeds voltage requirements of DO 160 Section 19 and Boeing D6-16050-5 Section 7.2
- Robust design, withstand tested to 5,000 VDC
- Durable steel and high-density polyethylene case for impact resistance

Application

The AE Techron T3700 Electric-Field Susceptibility Transformer was designed to meet or exceed the voltage requirements of DO 160 Section 19 and Boeing D6-16050-5 Section 7.2 testing.

It may also be used as a 1-to-37 step-up transformer for voltages up to 3700 V_{RMS}.

Description

The T3700 transformer is able to generate up to a 3700 V_{RMS} potential. It is withstand tested to 135% of rated output to ensure a long, trouble-free life. The turns ratio provides a 1-to-37 step up to the secondary winding.

The T3700 provides convenient input connectors via touch-proof, four-way binding posts. Standard 0.75-inch spacing of binding posts allows use of standard plugs.

A 1-amp fuse protects the unit against over-current conditions. A rugged,

impact-resistant case and robust design protects the transformer from accidental damage.

The T3700's voltage output meets or exceeds the requirements of DO 160 Section 19 and Boeing D6-16050-5 Section 7.2. It is safe for use by experienced staff.

Unit Setup

Safety First

Throughout these instructions, special emphasis is placed on good safety practices. The LIGHTNING FLASH and EXCLAMATION POINT graphics are used to highlight certain topics that require extra precaution.

Watch for These Symbols:



The lightning flash with the arrowhead symbol within an equilateral triangle is intended to alert the user to the presence of “dangerous voltage” inside the product that may constitute a risk of electric shock.



The exclamation point within an equilateral triangle is intended to alert the user to the presence of important operating and maintenance instructions in the literature accompanying the product.

Important Safety Instructions

1. Read and keep these instructions. Follow all instructions and heed all warnings.



2. Do not use this apparatus near water. To reduce the risk of fire or electric shock, do not expose this apparatus to rain or moisture. Do not expose this equipment to dripping or splashing and ensure that no objects filled with liquids, such as vases, are placed on the equipment.



3. Disconnect this product from all sources of electrical power before cleaning. Use a damp cloth for cleaning. Clean the outside of the product only.

4. Care should be taken so that objects do not fall into the product.

5. Do not block any ventilation openings. Install in accordance with the manufacturer's instructions.

6. Do not install near any heat sources such as radiators, heat registers, stoves, or other apparatus (including amplifiers) that produce heat.

7. Only use attachments/accessories specified by the manufacturer.



8. Refer all servicing to qualified service personnel. Servicing is required when the apparatus has been damaged in any way, such as liquid has been spilled or objects have fallen into the apparatus, the apparatus has been exposed to rain or moisture, does not operate normally, or has been dropped.

9. Do not remove product covers. No user serviceable parts inside. Refer servicing to qualified service personnel.

10. Always use the appropriate wire size and insulator for maximum voltage and current expected.

11. Operating conditions: 10°C to 40°C; Humidity: 70% or less, non-condensing.

Unpacking

Carefully unpack and inspect the unit. Please note any damage for future reference and notify the shipping company immediately if damage is found. Also, please save the shipping carton and materials as evidence of damage and/or for returning the unit for repair.

Connecting the T3700

Transformer (see Figure 1)

Before connecting the T3700, make sure all equipment you are connecting is disconnected from AC power.

1. Connect from the signal generator or another signal source to an AE Techron amplifier input.

2. Connect from a power amplifier, another power source, or a simulated load to your equipment under test.

3. Connect from a power amplifier to the T3700 4-way binding post input connectors. Connection can be made with cables terminated with spade lugs, pin connectors or bare wire.

4. Using the supplied connector and suitable cable, construct the output cable.

5. Connect to the T3700 positive (+) output connector.

6. Connect the grounding connector to earth ground using appropriate wire and connector.

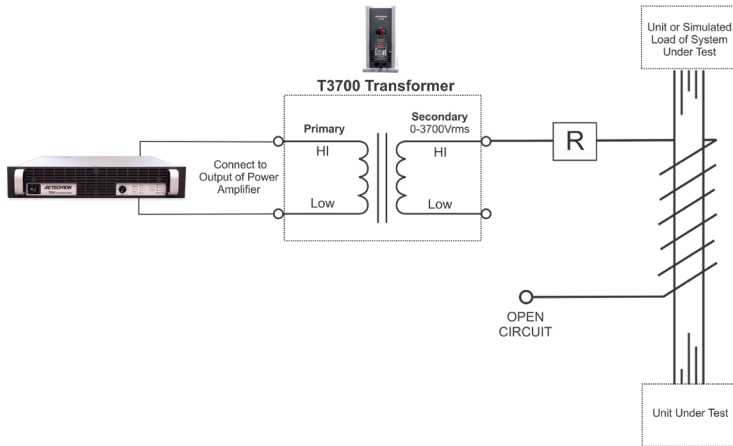

Figure 1 – DO 160 Section 19 Test Load Wiring

WARNING: This transformer produces potentially lethal voltages. While no direct connections are made with the product chassis, the radiating magnetic field produced by the transformer can produce voltage potentials on the product chassis. Connect the screw terminal grounding connector to earth ground to discharge any possible voltage potentials from the chassis.

NOTE: As per the Standard, the high-voltage output connection is not current limited. A resistor should be installed in the output wire for personal protection.

Equipment Maintenance

WARNING: To prevent electric shock, do not remove product covers. No user serviceable parts inside. Internal fuses should only be replaced by a service technician. Refer all servicing to qualified service personnel.

Disconnect this product before cleaning. Use a damp cloth for cleaning. Clean the outside of the product only.

Factory Service

If the unit fails to perform, it may need to be returned for Factory Service. All units under warranty will be serviced free of charge (customer is responsible for one-way shipping charges as well as any custom fees, duties, and/or taxes). Please review the Warranty included with this Instruction Sheet for more information.

All service units must be given Return Authorization by AE Techron, Inc. before being returned. Return Authorizations can be requested on our website or by contacting our Customer Service Department.

Please take extra care when packaging your unit for repair. It should be returned in its original packaging or a suitable alternative. Replacement packaging materials can be purchased for a nominal fee.

Please send all service units to the following address and be sure to include your Return Authorization Number on the box.

AE Techron, Inc.
Attn: Service Department / RMA#
2507 Warren Street
Elkhart, IN 46516

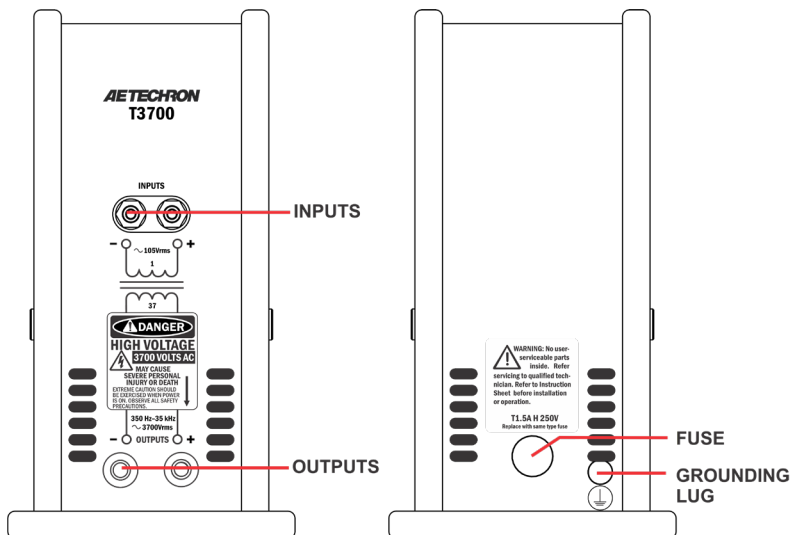

Figure 2 – T3700 Controls and Connectors

Specifications

Performance Specifications

Primary:

100 V_{RMS} maximum or 1 A_{RMS} maximum

Secondary:

3700 V_{RMS} maximum output

Physical Turns Ratio:

1-to-37 step up

Dielectric Test:

5 kVDC primary to case
5 kVDC secondary to case

Frequency Range:

250 Hz to 35 kHz

Protection:

Current-protected input

Controls and Connectors

(see Figure 2)

Input Terminals:

4-way binding posts

Output Terminals:

LGH high-voltage connector (+)
Banana jack (-)

Over-Current Protection:

Primary input limited via fuse to 1A (T1A H 250V)

Grounding Lug:

Screw terminal grounding connector. Connect to earth ground using appropriate wire and connector.

Physical Characteristics

Case:

Steel interior shell with a durable external shell made from high-density polyethylene for impact resistance.

Operating Conditions,

Temperature: 10°C to 40°C (50°F to 104°F)

Humidity: 70% or less, non-condensing

Recommended Ambient Temperature:

25°C (77°F)

Cooling:

Natural air convection

Weight:

16 lbs. (7.3 kg)

Dimensions (WxDxH):

5.25 in. x 10.375 in. x 9.75 in. (13.3 cm x 26.4 cm x 24.8 cm)

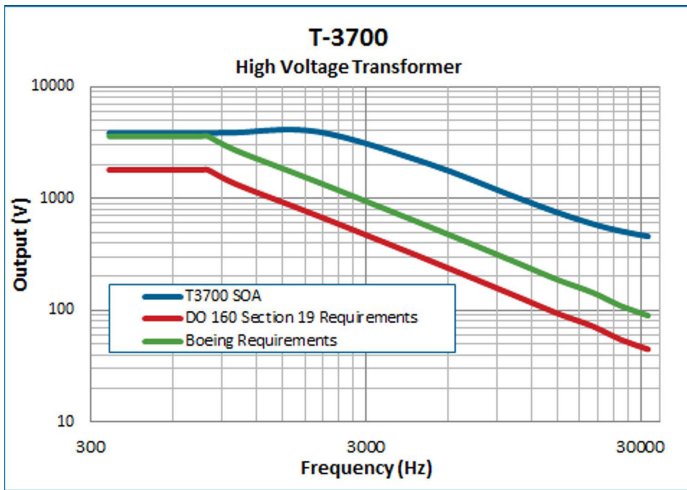

Figure 3 – T3700 Maximum SOA (safe operating area)

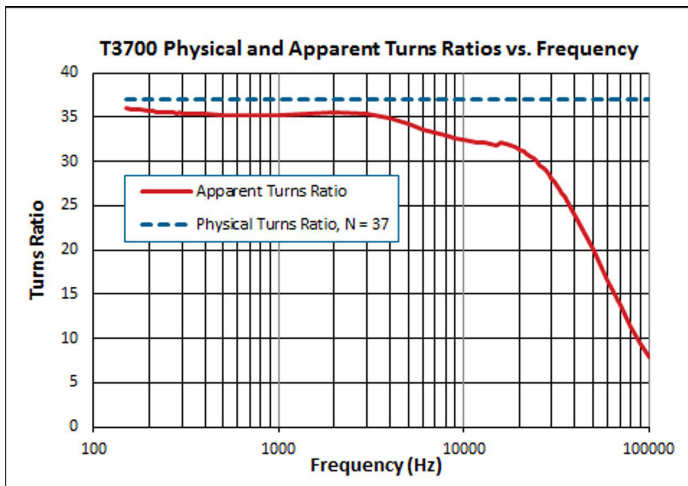

Figure 4– Physical and Apparent Turns Ratios vs. Frequency

Additional Product Information

This manual does not include all of the details of design, production, or variations of the equipment. Nor does it cover every possible situation which may arise during installation, operation or maintenance.

Additional information may be included with your unit via digital media and is also available at the AE Techron website at www.aetechron.com.

Information Accuracy

The information provided in this manual was deemed accurate as of the publication date. However, updates to this information may have occurred. To obtain the latest information for your unit, please visit the AE Techron website at www.aetechron.com.

DECLARATION OF CONFORMITY

Technical Construction File Route

Issued By: AE Techron, Inc.
2507 Warren Street
Elkhart, IN 46516

For Compliance Questions Only: Larry Shank
574-295-9495
lshank@aetechron.com

This Declaration of Conformity is issued under the sole responsibility of AE Techron, Inc., and belongs to the following product:

Equipment Type: Scientific and Laboratory

Model Name: T3700 Electric Field Susceptibility Transformer

EMC Standard:

EN 61326-1: 2013 – Electrical Equipment for Measurement, Control and Laboratory use — Emissions

Safety Standards:

BS EN 61010-1:2010 (incl. Corr. May 2011) – Safety requirements for electrical equipment for measurement, control, and laboratory use
and

BS EN 61558-1:2005 – Safety of power transformers, power supplies, reactors and similar products

And

BS EN 61558-2-4:2009 – Particular requirements for isolating transformers for general applications

I certify that the product identified above conforms to the requirements of the EMC Council Directive 2014/30/EU, and the Low Voltage Directive 2014/35/EU).

Signed:



Larry Shank
President

Place of Issue: Elkhart, IN, USA
Date of Issue: May 18, 2017

CE Affixing Date: May 08, 2017

Three-Year, No-Fault Warranty

SUMMARY OF WARRANTY

AE TECHRON INC., of Elkhart, Indiana (Warrantor) warrants to you, the ORIGINAL COMMERCIAL PURCHASER and ANY SUBSEQUENT OWNER of each NEW **AE TECHRON INC. product**, *for a period of three (3) years from the date of purchase, by the original purchaser (warranty period) that the product is free of defects in materials and workmanship and will meet or exceed all advertised specifications for such a product. We further warrant the new AE Techron product regardless of the reason for failure, except as excluded in the Warranty.*

ITEMS EXCLUDED FROM WARRANTY

This AE Techron Warranty is in effect only for failure of a new AE Techron product which occurred within the Warranty Period. It does not cover any product which has been damaged because of any intentional misuse, or loss which is covered under any of your insurance contracts. This warranty does not extend to any product on which the serial number has been defaced, altered, or removed. It does not cover damage to loads or any other products or accessories resulting from **AE TECHRON INC.** product failure. It does not cover

defects or damage caused by the use of unauthorized modifications, accessories, parts, or service.

WHAT WE WILL DO

We will remedy any defect, regardless of the reason for failure (except as excluded), by repair or replacement, at our sole discretion. Warranty work can only be performed at our authorized service centers or at our factory.

Expenses in remedying the defect will be borne by **AE TECHRON INC.**, including one-way surface freight shipping costs within the United States. (Purchaser must bear the expense of shipping the product between any foreign country and the port of entry in the United States and all taxes, duties, and other customs fees for such foreign shipments.

HOW TO OBTAIN WARRANTY SERVICE

When you notify us of your need for warranty service, we will give you an authorization to return the product for service. All components must be shipped in a factory pack or equivalent which, if needed, may be obtained from us for a nominal charge. We will take corrective actions within a reasonable time of the date of receipt of the defective product. If the repairs made by us are not satisfactory, notify us immediately.

DISCLAIMER OF CONSEQUENTIAL AND INCIDENTAL DAMAGES

You are not entitled to recover from us any consequential or incidental damages resulting from any defect in our product. This includes any damage to another product or products resulting from such a defect.

WARRANTY ALTERATIONS

No person has the authority to enlarge, amend, or modify this warranty. The warranty is not extended by the length of time for which you are deprived of the use of this product. Repairs and replacement parts provided under the terms of this warranty shall carry only the unexpired portion of this warranty.

DESIGN CHANGES

We reserve the right to change the design of any product from time to time without notice and with no obligation to make corresponding changes in products previously manufactured.

LEGAL REMEDIES OF PURCHASER

There is no warranty that extends beyond the terms hereof. This written warranty is given in lieu of any oral or implied warranties not contained herein. We disclaim all implied warranties, including, without limitation, any warranties of merchantability or fitness for a particular purpose. No action to enforce this Warranty shall be commenced later than ninety (90) days after expiration of the warranty period. This statement of warranty supersedes any others contained in this manual for AE Techron products.

AE Techron, Inc.

Customer Service Department
2507 Warren Street
Elkhart, IN 46516
U.S.A.
574.295.9495
www.aetechron.com



CR-600 Chattering Relay Accessory

The AE Techron **CR 600 Chattering Relay** is a cost-effective, rugged yet elegant solution to the DO 160 Section 19.3.5 “Spikes Induced into Interconnecting Cables” test requirement.

Internally built around a 50A high-current relay with two independent sets of contacts, the CR 600 was engineered for double the life before refurbishment.

The CR 600 uses quick-connect, touch-proof connectors to ensure efficient setup and a safe test environment. It also includes quick-clip test points for oscilloscope monitoring of tests in progress.

When driven from an intermittent voltage source like the AE Techron DSR 100-25 and utilizing test waveform, “Section 19.3.5 CR 600”, the CR 600 output meets the voltage (600V), duration (50 – 1000 μ s) and repetition-period (0.2 to 10 μ s) requirements specified by the DO-160 standard.

Application

The AE Techron CR-600 accessory was designed for use with AE Techron amplifiers to perform the Spikes Induced into Interconnecting Cables test as part of aviation test standards like RTCA DO160 Section 19.3.5.

Unit Setup

Safety First

Throughout these instructions, special emphasis is placed on good safety practices. The LIGHTNING FLASH

For testing to these Specifications:

- DO 160 Section 19.3.5

Features

- Coil Voltage: 24 VDC
- Coil Current: 84 mA
- Contact Rating: 30A
- Typical Pulse Voltage: >700 Vpp
- Includes oscilloscope connection points for voltage monitoring

and EXCLAMATION POINT graphics are used to highlight certain topics that require extra precaution.

Watch for These Symbols:



The lightning flash with the arrowhead symbol within an equilateral triangle is intended to alert the user to the presence of “dangerous voltage” inside the product that may constitute a risk of electric shock.



The exclamation point within an equilateral triangle is intended to alert the user to the presence of important operating and maintenance instructions in the literature accompanying the product.

Important Safety Instructions

1. Read and keep these instructions. Follow all instructions and heed all warnings.

2. Do not use this apparatus near water. To reduce the risk of fire or electric shock, do not expose this apparatus to rain or moisture. Do not expose this equipment to dripping or splashing and ensure that no objects filled with liquids, such as vases, are placed on the equipment.



3. Disconnect this product from all sources of electrical power before cleaning. Use a damp cloth for cleaning. Clean the outside of the product only.



4. Care should be taken so that objects do not fall into the product.
5. Do not block any ventilation openings. Install in accordance with the manufacturer's instructions.
6. Do not install near any heat sources such as radiators, heat registers, stoves, or other apparatus (including amplifiers) that produce heat.
7. Only use attachments/accessories specified by the manufacturer.

8. Refer all servicing to qualified service personnel. Servicing is required when the apparatus has been damaged in any way, such as liquid has been spilled or objects have fallen



into the apparatus, the apparatus has been exposed to rain or moisture, does not operate normally, or has been dropped.

9. Do not remove product covers. No user serviceable parts inside. Refer servicing to qualified service personnel.
10. Always use the appropriate wire size and insulator for maximum voltage and current expected.
11. Operating conditions: 10°C to 40°C; Humidity: 70% or less, non-condensing.

Unpacking

Carefully unpack and inspect the unit. Please note any damage for future reference and notify the shipping company immediately if damage is found. Also, please save the shipping carton and materials as evidence of damage and/or for returning the unit for repair.

CR-600 Setup

(see **Figure 1**)

1. Before connecting the CR-600 unit, make sure all equipment you are connecting is disconnected from AC power.

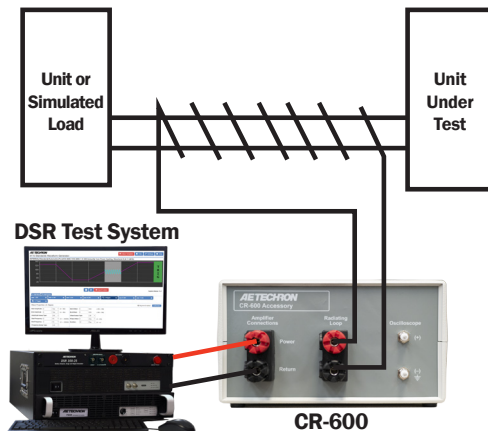

Figure 1 – Test Setup for RTCA DO160 Section 19.3.5 using the CR-600

2. Connect from your test system or signal generator/power amplifier combination to the dual binding posts labeled Amplifier Connections on the CR-600 front panel. Connect the positive output terminal from your test system or amplifier to the connector labeled Power on the CR-600. Connect the negative/ground output terminal from your test system or amplifier to the connector labeled Return.
3. Connect the radiating loop to be wired around the connecting cables from the DUT to simulated load, connecting the two ends of the loop to the CR-600's front-panel dual binding posts labeled Radiating Loop.
4. If desired, two oscilloscope probes can be connected to the (+) and (-) Oscilloscope terminals on the front panel. These probes can be used for monitoring the voltage applied to the radiating loop.

NOTE: If the oscilloscope ground is connected to the positive oscilloscope terminal, the chattering pulse train will not occur. This will not damage the unit

and, after corrections have been made, normal operation can resume.

Operation

1. Configure your test system or signal generator/power amplifier combination to apply a 28 VDC to the Amplifier Connections terminals of the CR-600. This will cause the chattering pulse train to begin.
2. Adjust the duration and duty cycle of the 28 VDC supply to adjust the length and repetition period of the chattering pulse train.

NOTE: If the CR-600 is not performing as expected, ensure that all of the connections to the equipment have been made correctly. If the oscilloscope ground has been connected to the positive oscilloscope terminal, the chattering pulse train will not occur. This will not damage the unit and, after corrections have been made, normal operation can resume.

Sample Output

Refer to **Figures 2 - 4** for a representation of the expected output of the CR-600 when used for testing to the DO160 standards.

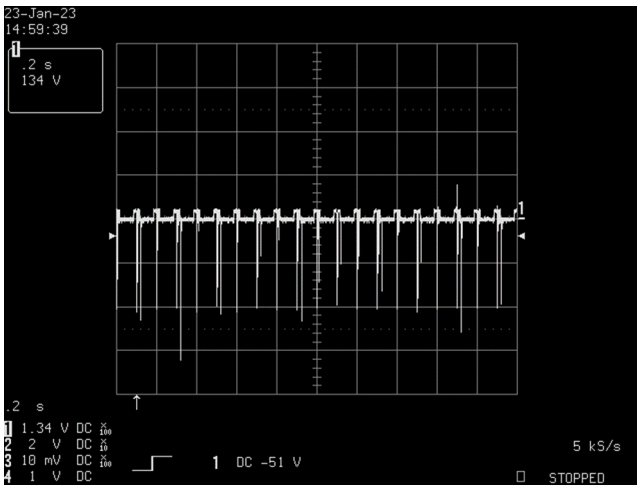

Figure 2 – Example of output from the CR-600 when adjusted to yield a pulse repetition rate of eight to ten pulses per second

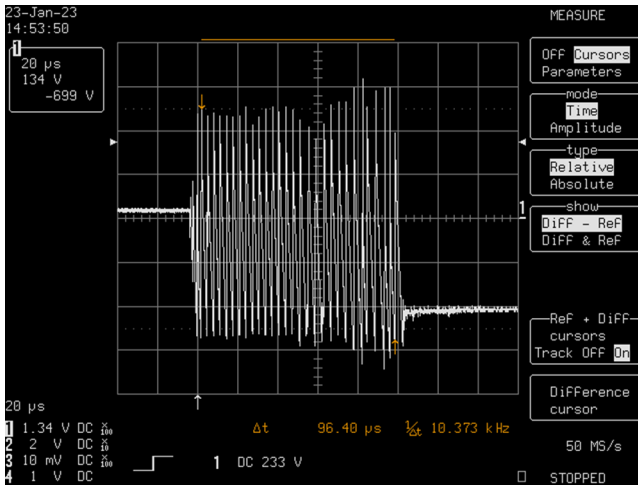

Figure 3 – Example of output from the CR-600 when adjusted for a pulse sequence with an amplitude greater than or equal to 600 Vpp and a total duration of 50 to 1000 microseconds

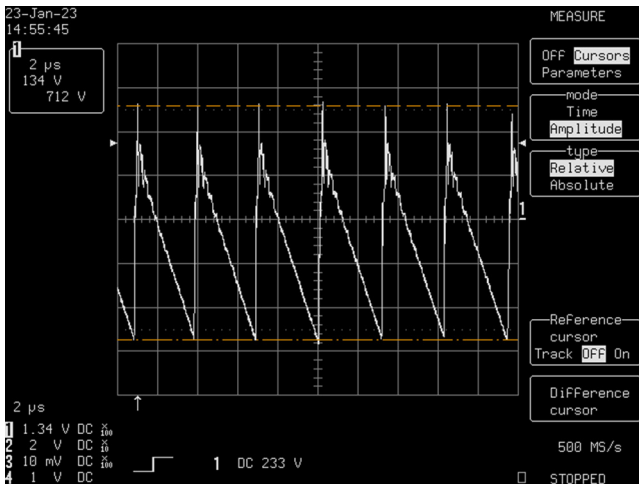

Figure 4 – Example of output from the CR-600 when adjusted for a repetition period of 0.2 to 10 microseconds

Equipment Maintenance



To prevent electric shock, do not remove product covers. No user serviceable parts inside.

Refer all servicing to qualified service personnel.

Disconnect this product before cleaning. Use a damp cloth for cleaning. Clean the outside of the product only.

Factory Service

If the unit fails to perform, it may need to be returned for Factory Service. All units under warranty will be serviced free of charge (customer is responsible for one-way shipping charges as well as any custom fees, duties, and/or taxes). Please review the Warranty included with this Instruction Sheet for more information.

All service units must be given Return Authorization by AE Techron, Inc. before being returned. Return Authorizations can be requested on our website or by contacting our Customer Service Department.

Please take extra care when packaging your unit for repair. It should be returned in its original packaging or a suitable alternative. Replacement packaging materials can be purchased for a nominal fee.

Please send all service units to the following address and be sure to include your Return Authorization Number on the box.

AE Techron, Inc.
Attn: Service Department / RMA#
2507 Warren Street
Elkhart, IN 46516

Specifications

Performance Specifications

Coil Voltage: 24 VDC

Coil Current: 84 mA

Contact Rating: 30A

Typical Pulse Voltage: >700 Vpp

Controls and Connectors

Amplifier Connections:

Dual binding posts

Radiating Loop:

Dual binding posts

Oscilloscope:

Dual turret connectors

Physical Characteristics

Case:

Injection-molded plastic

Operating Conditions,

Temperature: 10°C to 40°C (50°F to 104°F)

Humidity: 70% or less, non-condensing

Recommended Ambient Temperature:

25°C (77°F)

Cooling:

Natural air convection

Weight:

1.5 lbs. (0.68 kg)

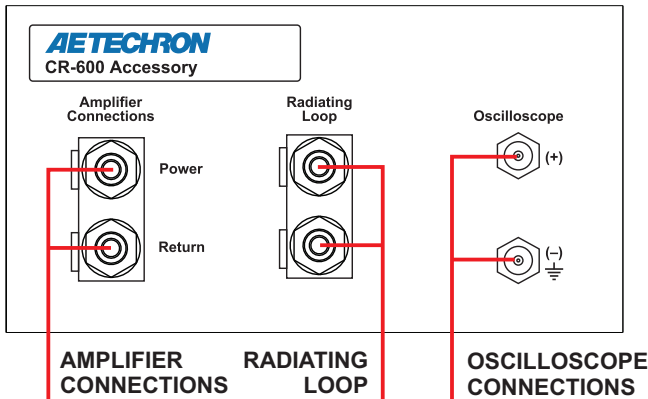

Figure 3 – CR 600 Connectors

Dimensions (WxDxH):

6.25 in. x 7.25 in. x 3.25 in. (15.9 cm x 18.4 cm x 8.3 cm)

Additional Product Information

These instructions do not include all of the details of design, production, or variations of the equipment. Nor do they cover every possible situation which may arise during installation, operation or maintenance.

Information Accuracy

The information provided in this manual was deemed accurate as of the publication date. However, updates to this information may have occurred. To obtain the latest information for your unit, please visit the AE Techron website at www.aetechron.com.

Trademark Notice

AE Techron is a registered trademark of AE Techron, Inc. Other trademarks are the property of their respective owners.

One-Year, No-Fault Warranty

SUMMARY OF WARRANTY

AE TECHRON INC., of Elkhart, Indiana (Warrantor) warrants to you, the ORIGINAL COMMERCIAL PURCHASER and ANY SUBSEQUENT OWNER of each NEW **AE TECHRON INC. product**, for a period of one (1) year from the date of purchase, by the original purchaser (warranty period) that the product is free of defects in materials and workmanship and will meet or exceed all advertised specifications for such a product. We further warrant the new **AE Techron product regardless of the reason for failure, except as excluded in the Warranty.**

ITEMS EXCLUDED FROM WARRANTY

This AE Techron Warranty is in effect only for failure of a new AE Techron product which occurred within the Warranty Period. It does not cover any product which has been damaged because of any intentional misuse, or loss which is covered under any of your insurance contracts. This warranty does not extend to any product on which the serial number has been defaced, altered, or removed. It does not cover damage to loads or any other products or accessories resulting from **AE TECHRON INC.** product failure. It does not cover

defects or damage caused by the use of unauthorized modifications, accessories, parts, or service.

WHAT WE WILL DO

We will remedy any defect, regardless of the reason for failure (except as excluded), by repair or replacement, at our sole discretion. Warranty work can only be performed at our authorized service centers or at our factory.

Expenses in remedying the defect will be borne by **AE TECHRON INC.**, including one-way surface freight shipping costs within the United States. (Purchaser must bear the expense of shipping the product between any foreign country and the port of entry in the United States and all taxes, duties, and other customs fees for such foreign shipments.

HOW TO OBTAIN WARRANTY SERVICE

When you notify us of your need for warranty service, we will give you an authorization to return the product for service. All components must be shipped in a factory pack or equivalent which, if needed, may be obtained from us for a nominal charge. We will take corrective actions within a reasonable time of the date of receipt of the defective product. If the repairs made by us are not satisfactory, notify us immediately.

DISCLAIMER OF CONSEQUENTIAL AND INCIDENTAL DAMAGES

You are not entitled to recover from us any consequential or incidental damages resulting from any defect in our product. This includes any damage to another product or products resulting from such a defect.

WARRANTY ALTERATIONS

No person has the authority to enlarge, amend, or modify this warranty. The warranty is not extended by the length of time for which you are deprived of the use of this product. Repairs and replacement parts provided under the terms of this warranty shall carry only the unexpired portion of this warranty.

DESIGN CHANGES

We reserve the right to change the design of any product from time to time without notice and with no obligation to make corresponding changes in products previously manufactured.

LEGAL REMEDIES OF PURCHASER

There is no warranty that extends beyond the terms hereof. This written warranty is given in lieu of any oral or implied warranties not contained herein. We disclaim all implied warranties, including, without limitation, any warranties of merchantability or fitness for a particular purpose. No action to enforce this Warranty shall be commenced later than ninety (90) days after expiration of the warranty period. This statement of warranty supersedes any others contained in this manual for AE Techron products.

AE Techron, Inc.

Customer Service Department
2507 Warren Street
Elkhart, IN 46516
U.S.A.
574.295.9495
www.aetechron.com