



## CIS-25 Data Sheets Conducted/Induced Susceptibility EMC Testing Kit

### Kit Includes:

DSR 100-25 Test System

T 1000 Transformer

T 2000 Transformer

T 3700 Transformer

CR 600, Chattering Relay

Two Hours of Expert Consulting

Secure Storage Case

Plus all required cables and connectors

The **CIS-25 Test Kit** combines into a single, complete package the items needed to accurately test to important Aviation standards like DO-160 sections 18 and 19.

Included with the kit are three coupling transformers (T1000, T2000, and T3700), the CR 600 Chattering Relay accessory, and a secure storage cabinet to keep the equipment safe.

The CIS-25 kit also comes with two hours of expert consulting provided by EMC Specialist **Patrick G Andre**, who will answer any questions you might have about set-up or testing.

The DSR 100-25 test system, which is included with the CIS-25 Test Kit, has power in reserve. Each of our DSR Series models provides continuous DC power as rated, and is able to provide 4X rated power for in-rush testing up to 200 ms (such as is required in DO 160 Section 16). Plus, the DSR 100-25 system includes the complete 3110A Standard's Library, so the CIS-25 Test Kit can be used for many other tests.

The equipment is easy to set up and use; all elements in the kit are robust and will provide you with many years of trouble-free service.



## DSR 100 Series Dropout, Surge, Ripple Simulator and AC/DC Voltage Source

Includes library of 3000+ pre-entered Automotive and Aviation Standards' test routines

Operate as a free-standing system using the included monitor, keyboard and mouse, or control via LAN



Very easy to modify existing tests or build new test sequences

Can function as a controller or node in a larger test system via built-in LAN and GPIO controls

Models from 25A to 200A continuous output current available

### Key Performance Capabilities:

- 4-Quadrant Can source and sink current
- Up to  $\pm 100V$  DC supply for 12V - 48V systems
- 300 kHz Sine DC ripple tests for all major standards
- 20 mV Noise Floor
- 3 $\mu s$  Rise time exceeds Surge and Drop-out slew rate requirements
- 3m $\Omega$  DC source impedance - better than ISO 7637-2 requirements
- Supports ground reference and supply offset testing required for ISO 16750-2 Sect. 4.8 and other similar standards

**AE Techron's DSR 100 Series** systems provide complete, single-box solutions for immunity testing. They include a simple-to-use yet powerful standards waveform generator matched with an industry leading power supply technology and come with an extensive library of tests for many automotive and aviation standards.

All models of the DSR 100 Series are 4-quadrant, allowing them to source and sink current. The DSR Series has power in reserve; each model provides continuous DC power as rated, and is able to provide 4X rated power for in-rush testing up to 200 ms, as is required in DO 160 Section 16.

### Pre-entered tests for the following Industry standards:

- ANSI ASAE EP455 (Feb03)
- IEC 6100-4-16
- IEC 6100-4-19
- ISO 7637-2 (2014) (E)
- ISO 16750-2 (2023)
- ISO 21780:2020
- ISO 21848
- JASO D 001-94 (1994-03-31)
- MIL STD 461G
- MIL STD 704F
- SAE J1113-2 JUL2004
- SAE J1113-11-202303 MAR2023
- SAE J2139-201412 DEC2014
- SAE J2628-201806 JUN2018

*See page 2 for manufacturer-specific tests.*

## Manufacturer Specific Standards

Airbus ABD0100.1.8 Issue E	DAF BSL-003 (1998-12)	Hyundai ES 95400-10 (2007-11-14)
Airbus ABD0100.1.8.1 Issue C	DAF BSL-006 (2009-04)	Hyundai ES 96100-02 (2006-11-16)
Audi I EE-32 (2006-06)	Daimler Chrysler DC-10842 (2003-12)	JLR-EMC-CS v1 Amendment 4 (Nov 2013)
BMW GS 95003-2 (2010-01)	Daimler Chrysler PF-9326 Change D	Mazda MES PW67600 (1995-07)
BMW GS 95024-2-1 (2010-01)	DO160G	MIL STD 461G
BMW GS 95024-2-2 (2011-01)	Fiat 9-90110 Issue 13 (2007-03)	MIL-HDBK-704-8
Boeing-D6-16050-5-C	Ford CS-2009.1	Mitsubishi ES-X82010 Rev Q (2007-01)
Boeing-D6-36440E	Ford FMC1278	Mitsubishi ES X82115 Rev C (2009-03)
Case New Holland ENS0310 (12-2-2010)	General Motors GMW3172_H (July 2010)	Nissan 28400NDS02 Rev 3 (1999-07)
Chrysler CS-11809 (2009-05-29)	General Motors GMW3172_I	Nissan 28400NDS03 Rev 3 (2005-08)
Chrysler CS-11979 (2010-04-13)	Harley-Davidson EG-812-22613	Nissan 28401NDS02 Rev 4 (2008-08)
Claas CN 05 0215 (2004-12)	Honda 30AA	Toyota TSC70212G (2007-06)
Cummins 14269 (06201-028)	Honda 7794Z-SAAA-000 (28.12.2004)	Volkswagen VW 80101 (2009-03)
Cummins 14387 (102020-119)	Hyundai ES 39110-00 (2005-08)	Volkswagen VW 80000 (2009-10)
		Volkswagen VW TL 820 66

### DSR 100 - 25

**Voltage Output Range:** -70V to +70V  
**Output Current:** 0A to 25A continuous  
**Peak Current:** 50Ap for 200 ms  
**Bandwidth (-3dB), Full Signal:** DC to 300 kHz  
**Small Signal:** 3Vp-p to 1 MHz  
**Source Impedance:** 4.4 mΩ + 0.43 μH  
**Supply Voltage:** Single-phase 120V ±10%, 30A, 50/60 Hz; 230V, 15A version available  
**Dimensions (HxWxD):** 9.5 x 20 x 25 in. (63.5 x 24.1 x 50.8 cm)  
**Weight:** Approximately 76.5 lbs. (34.7 kg)

### DSR 100 - 75

**Voltage Output Range:** -70V to +70V  
**Output Current:** 0A to 75A continuous  
**Peak Current:** 150Ap for 200 ms  
**Bandwidth (-3dB), Full Signal:** DC to 300 kHz  
**Small Signal:** 3Vp-p to 1 MHz  
**Source Impedance:** 4.4 mΩ + 0.43 μH  
**Supply Voltage:** 3-phase 208V ±10%, 20A, 50/60 Hz; 400V, 10A version available  
**Dimensions (HxWxD):** 45.8 x 22.6 x 31.6 in. (116.3 x 57.3 x 80.2 cm)  
**Weight:** Approximately 353 lbs. (160 kg)

### DSR 100 - 155

**Voltage Output Range:** -70V to +70V  
**Output Current:** 0A to 155A continuous  
**Peak Current:** 300Ap for 200 ms  
**Bandwidth (-3dB), Full Signal:** DC to 300 kHz  
**Small Signal:** 3Vp-p to 1 MHz  
**Source Impedance:** 3 mΩ + 2.2 μH  
**Supply Voltage:** 3-phase 208V ±10%, 20A, 50/60 Hz; 400V, 10A version available  
**Dimensions (HxWxD):** 45.80 x 22.56 x 31.56 in. (116.33 x 57.3 x 80.16 cm)  
**Weight:** Approximately 479 lbs. (217 kg)

### DSR 100 - 200

**Voltage Output Range:** -100V to +100V  
**Output Current:** 0A to 200A continuous  
**Peak Current:** 800Ap for 200 ms  
**Bandwidth (-3dB), Full Signal:** DC to 150 kHz  
**Small Signal:** 20Vp-p to 250kHz  
**Source Impedance:** 3 mΩ + 2.2 μH  
**Supply Voltage:** 3-phase 208V ±10%, 125A, 50/60 Hz; 400V, 65A version available  
**Dimensions (HxWxD):** 69.25 x 22 x 28 in. (175.9 x 55.9 x 71.1 cm)  
**Weight:** Approximately 850 lbs. (386 kg)

## Common Data (all models)

**Operation:** 4-quadrant, bi-polar operation  
**Output Rise Time:** <3 μS  
**Remote Control:** GPIO, LAN  
**Cooling:** Internal forced-air fans  
**Protection:** Over/under voltage, over current, over temperature  
**Trigger:** Automatic repeat, manual trigger, external trigger via GPIO or LAN  
**Input, Signal In:** BNC connector; **LAN:** Ethernet connector  
**Output, DUT Supply +/-:** High-current connectors; **Signal Output:** BNC connector; **LAN:** Ethernet connector

**Waveforms:** Sine wave sweep, ripple (cranking), DC source, triangle wave, square wave, sawtooth wave  
**Control Functions:** Trigger, fixed loop, variable loop, template playback, GPIO output, LAN output  
**Operating Environment,**  
**Temperature:** 10°C to 50°C (50°F to 122°F), Maximum Output Power de-rated above 30°C (86°F).  
**Humidity:** 70% or less, non-condensing  
**Atmospheric Pressure:** 86 kPa (860 mbar) to 106 kPa (1,060 mbar)





## 3110A

Up to 1 MHz EMC Testing

### Features

- Easiest-to-use LF wave sequence generator
- 3000+ automotive and aviation standard's tests included
- Dramatically reduces test time for repetitive test sequences
- Semi-automatic calibration routine significantly reduces labor-intensive tasks (like CS101)
- Very easy to modify included waveform sequences or create new ones



Microsoft  
Partner

**AE Techron's 3110A** is a simple-to-use yet powerful standards waveform generator. It can be combined with other AE Techron products to quickly create a wide range of powerful and intelligent EMC test solutions.

The 3110A outputs a standard analog signal that can work with any AE Techron amplifier or other LF amplifiers that you already have. When coupled with the AE Techron model 7234 amplifier, the 3110A can create virtually all waveforms, DC offsets, dropouts and surges needed for EMC tests with rise/fall times of 2  $\mu$ s or greater and frequencies from DC to 1 MHz.

The 3110A software is built around the concept of a waveform segment. Each waveform segment can have a unique waveform, (sine, square, triangle, and/or DC offset). Frequency, amplitude and DC offset can be clipped, fixed, variable or swept. Segments can be calibrated (as required in CS101) and set to continue on to the next segment or to hold for an external trigger.

The power of the system occurs when waveform segments are linked to create test sequences. These test sequences can be of any length and can be run as a single sequence, looped, or looped with multiple variables changing within the test sequence (as required in multiple Toyota and GM standards). Finally, multiple sequences can be combined to create a single customized extended test.

An extensive library of 3000+ tests for many automotive, aviation and industry Standards makes it possible for the 3110A to save time from day one. And, for customers that require over-testing or testing for products that have no predefined standard, tests from the Standards Library can be easily modified and saved for later use.

The 3110A delivers extensive capabilities for LF EMC testing with very short training-time requirements. Plus, it makes it easy to automate repetitive and labor-intensive tasks, making the 3110A a very efficient and cost-effective solution for LF EMC testing.

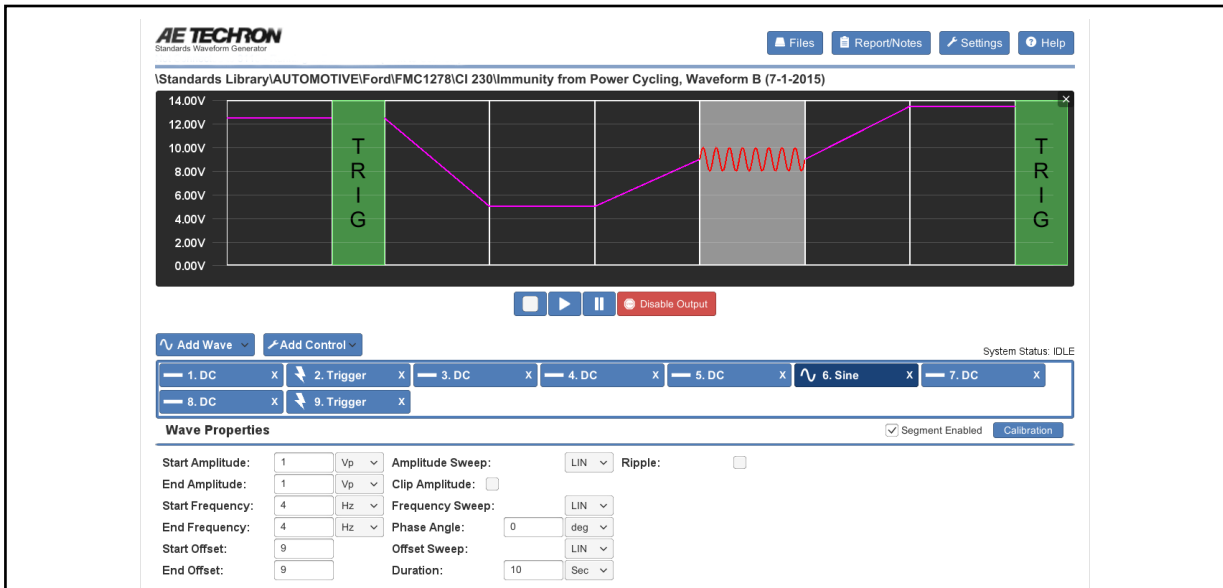

## HOW TO BUILD A TEST

Tests are created by combining wave segments together with other wave segments and/or control segments.

**WAVE SEGMENTS** (including sine, ripple, square, triangle, sawtooth, and DC offset) are the basic building blocks of each test.

The frequency, amplitude, and DC offset of each wave segment can be easily adjusted using the Wave Properties window and defined as fixed or linear, logarithmic or exponential sweep, with wave segment durations as short as 50  $\mu$ s.

**CONTROL SEGMENTS** like Fixed Loop, Variable Loop, and Trigger make the 3110A able to reproduce very complex standards. The test shown below highlights several key abilities made possible by these control segments.

A multi-step waveform can start at one level/condition, then be repeated, with up to four variables changing during the wave segment duration. Single or multi-step waveforms can be made to repeat (or loop) and these repeating waveforms can be nested within a larger simple or repeating waveform.

At any point during a waveform sequence, the program can be automatically paused (either holding the previous condition or muting) and wait for an external trigger before resuming.

**THE RESULT** is a complex waveform sequence that takes only minutes to setup, saving hours in both training and programming time compared to alternative EMC test generators.

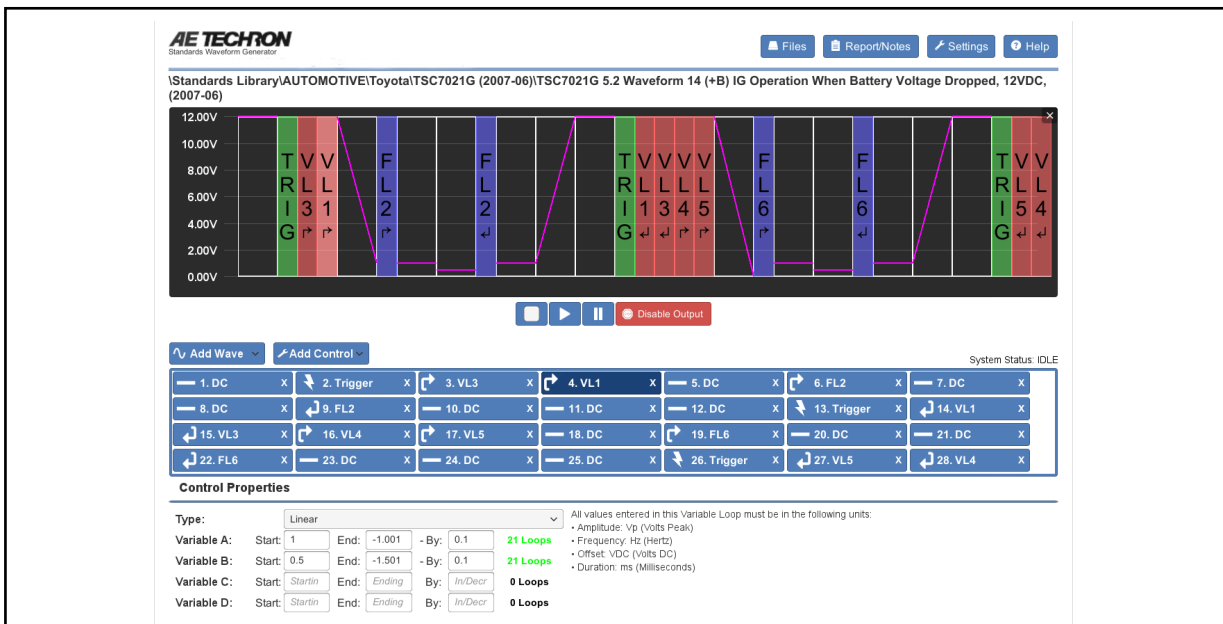

## Technical Details - Hardware

**Output channels:** 1

**Output Voltage:** 10 Vp

**Signal Generation:**

**DAC:**

18 bit

DC – 20 kHz (any wave form)

3  $\mu$ s full scale (includes settling time)

**Minimum pulse duration,**

**Burst:** <15  $\mu$ s

**Continuous:** 30  $\mu$ s

**Sine:**

14 bit

DC – 1 MHz

400 Msp

0.01 Hz or better frequency resolution

.0002 degree phase granularity

**Amplitude:**

76  $\mu$ V resolution

**Frequency,**

**Stability:**  $\pm$ 50 ppm

**Accuracy:**  $\pm$ 0.1%

## Control, Status, I/O

**Front Panel:**

**On/Off/Breaker**

**Signal Output:** BNC (analog - 10Vp)

**LED Displays:** Power, System Fault,  
Signal-In Enabled

**Back Panel:**

**Power Connection:**

120VAC: IEC cable with NEMA 5-15

230VAC: IEC cable with CEE 7/7

**Fuse:** 2A, 250V slow blow (5 mm)

## Physical Characteristics

**Chassis:**

The 3110A is designed for table-top or rack-mounted operation. The chassis is aluminum with a black powder-coat finish. The unit occupies two EIA 19-inch-wide units.

**Weight:** 9.5 lbs (4.31 kg)

**Shipping Weight:** 19.5 lbs (8.85 kg)

**AC Power:**

Single-phase, 120 VAC, 50/60 Hz, 2A service; 230 VAC, 50/60 Hz, 2A model available

**Dimensions:**

19 in. x 11.75 in. x 3.5 in.

(48.3 cm x 29.8 cm x 8.9 cm)

## Technical Highlights – Software

**Waveforms Supported:**

Sine, Ripple, DC, Triangle, Square, Rectangle, Sawtooth

**Waveform Modifiers:**

Amplitude, frequency and DC offset (fixed or linear, logarithmic\* or exponential sweep); phase angle; duration; clipped amplitude; and ripple on AC

**Waveform Controls:**

Trigger (user, GPIO, LAN), Fixed Loop, Variable Loop, Scripted Variable Loop, Template Playback, GPIO Output, LAN Output

**Minimum Step Size (isolated):**

25  $\mu$ s  $\pm$ 3  $\mu$ s

**DC Quiescent Noise:**

5 mV<sub>p-p</sub>

**Test Capabilities,**

**Minimum Waveform Duration:** 50  $\mu$ s

**Maximum Number of Loop Repeats:** >1 million

**Storage Capabilities, Number of Tests:**

300,000 (expandable to 1 million)

See Capabilities sheet for loop characteristics

\*Logarithmic sweep available for sine, ripple and DC offset waveforms only.

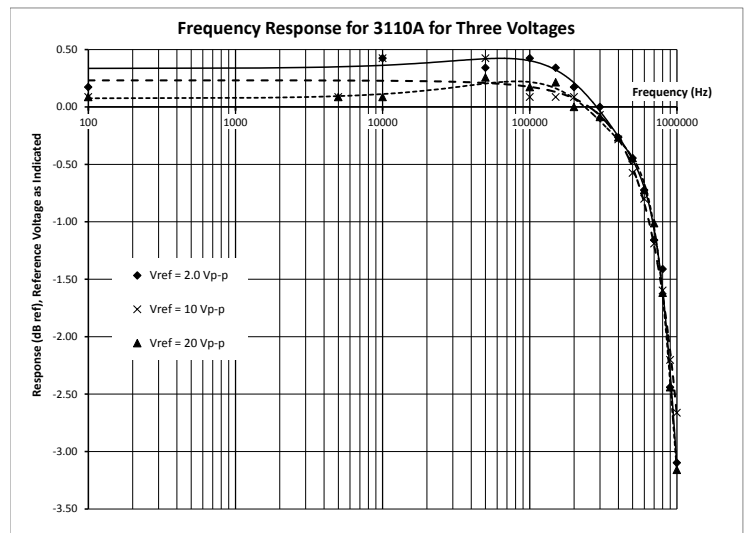

**CE** 230V versions of this product bear the CE mark

AE Techron Sales Representative



## T1000 Transformer for Magnetic-Field Susceptibility Testing

### For testing to these Specifications:

- DO 160 Section 19
- Boeing D6-16050-5 Section 7.2

### Features

- Up to 100 A<sub>RMS</sub> secondary current
- Exceeds AF Magnetic Field test requirements of DO 160 Section 19 and Boeing D6-16050-5 Section 7.2
- Circuit breaker protected from over-current
- Durable steel and high-density polyethylene case for impact resistance

The AE Techron **T1000 Magnetic-Field Susceptibility Transformer** was designed to exceed the AF Magnetic Field susceptibility test requirements of DO 160 Section 19 and Boeing D6-16050-5 Section 7.2.

It may also be used as 10-to-1 step-down transformer for output currents of up to 100 A<sub>RMS</sub>.

The T1000 transformer provides up to 300 A-m and is able to generate up to 100A. The turns ratio provides a ten-to-one step down to the secondary winding.

The T1000 provides convenient input connectors via binding posts. Standard 0.75-inch spacing of binding posts allows use of standard plugs. Output is via 150A feed-through terminal block.

A 12-amp circuit breaker protects the unit against over-current conditions. A rugged, impact-resistant case and robust design protects the transformer from accidental damage.

The T1000 transformer is for use by experienced staff.

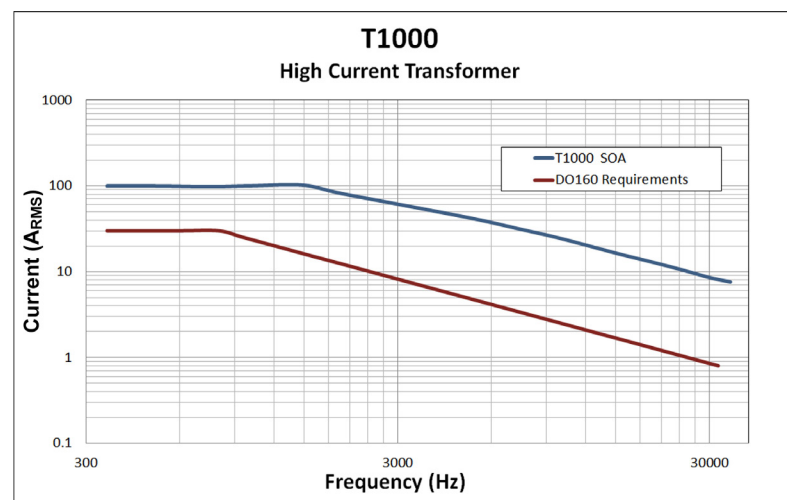

Figure 1 – T1000 Maximum SOA (safe operating area)

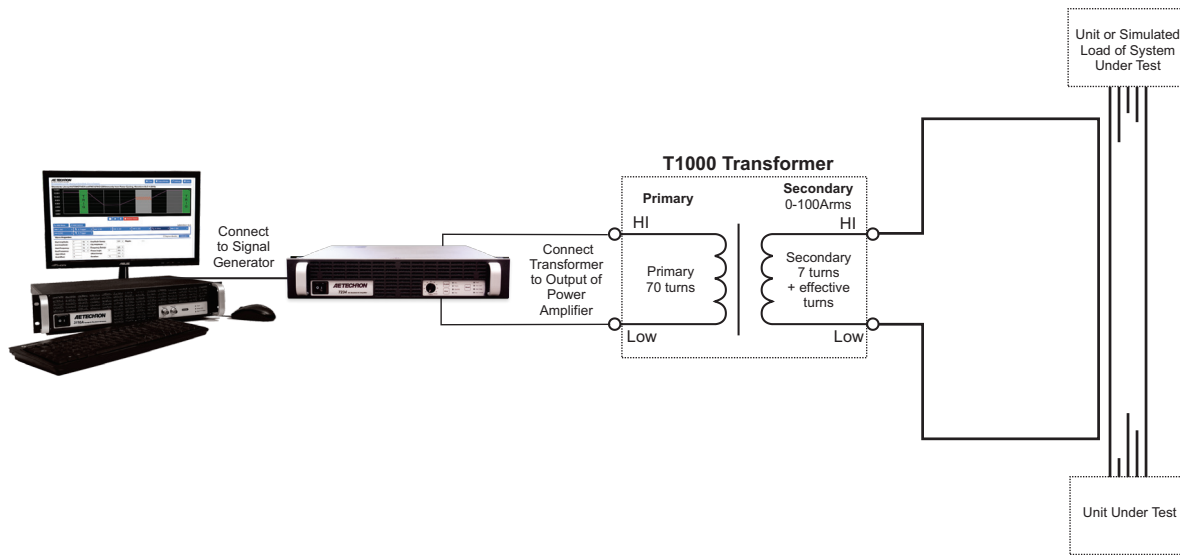

Figure 2 – Sample Application: DO 160 Section 19 Test Load Wiring

## Specifications

### Performance Specifications

**Primary:**

200 V<sub>P</sub> maximum

**Secondary:**

20.0 V<sub>P</sub> maximum output

**Dielectric Test:**

1200 VDC

**Turns Ratio::**

Ten-to-one step down

**Protection:**

Input power-protected via circuit breaker

### Controls and Connectors

(see Figure 3)

**Input Terminals:**

4-way binding posts

**Output Terminals:**

Feed-through terminal block (150A); accepts up to AWG 1/0 wire.

**Circuit Breaker:**

Primary input limited to 12A; push to reset

### Physical Characteristics

**Case:**

Steel interior shell with a durable external shell made from high-density polyethylene for impact resistance.

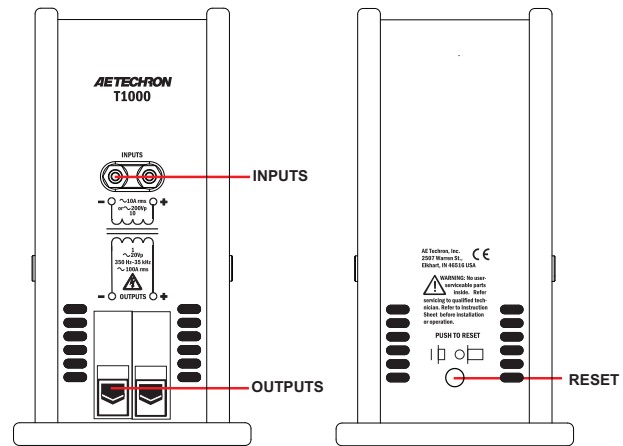

Figure 3 – T1000 Controls and Connectors

### Operating Conditions,

**Temperature:** 10°C to 40°C (50°F to 104°F)

**Humidity:** 70% or less, non-condensing

**Recommended Ambient Temperature:**

25°C (77°F)

**Cooling:**

Natural air convection

**Weight:**

15 lbs. (6.8 kg)

**Dimensions (HxWxD):**

9.75 in. x 5.25 in. x 10.375 in. (24.8 cm x 24.8 cm x 13.3 cm x 26.4 cm)

*AE Techron Sales Representative*





## T2000 Transformer for LF Conducted Susceptibility Testing

### Features

- Frequency response – 10 Hz to 250 kHz
- Turns ratio – 2:1 step down
- Audio power – 200W MAX
- Meets the LF Conducted Susceptibility test requirements of DO 160 Section 18
- Circuit breaker protected from over-current on secondary
- Durable steel and high-density polyethylene case for impact resistance

### For testing to these Specifications:

- Chrysler CS-11809 (2009)
- DaimlerChrysler DC-10615
- DO 160 Section 16
- DO 160 Section 18
- Ford FMC 1278
- GLloyd VI-7-2
- ISO 11452-10
- EMC-CS-2010JLR V1.1 (2011-01)
- MIL STD 461 D CS 101
- MIL STD 461 D CS 109
- MIL STD 461 E CS 101
- MIL STD 461 E CS 109
- MIL STD 461 F CS 101
- MIL STD 461 F CS 109
- MIL-STD-704
- Mitsubishi ES-X82115
- SAE J1113-2
- Tata TST/TS/WI/257

The AE Techron **T2000 Audio-Bandwidth Transformer** was designed to meet or exceed the LF conducted susceptibility test requirements of DO 160 Section 18. The T2000 is used to apply the required test signals to the lines under test for ripple voltage tests and continuous or transient conducted immunity tests.

It may also be used as 2-to-1 step-down transformer. The secondary can support up to 40 A<sub>P</sub>.

The T2000 transformer supports up to 200W and is able to pass up to 40 A<sub>P</sub> on the secondary. The turns ratio provides a two-to-one step down.

The T2000 provides convenient input connectors via binding posts. Standard 0.75-inch spacing of binding posts allows use of standard plugs. Output is via feed-through terminal block connectors (76A); accepts up to AWG 6 wire.

A thermal breaker protects the unit against over-current conditions on the primary. A 35A<sub>RMS</sub> breaker protects the unit against over-current conditions on the secondary. A rugged, impact-resistant case and robust design protects the transformer from accidental damage.

The T2000 transformer is for use by experienced staff.

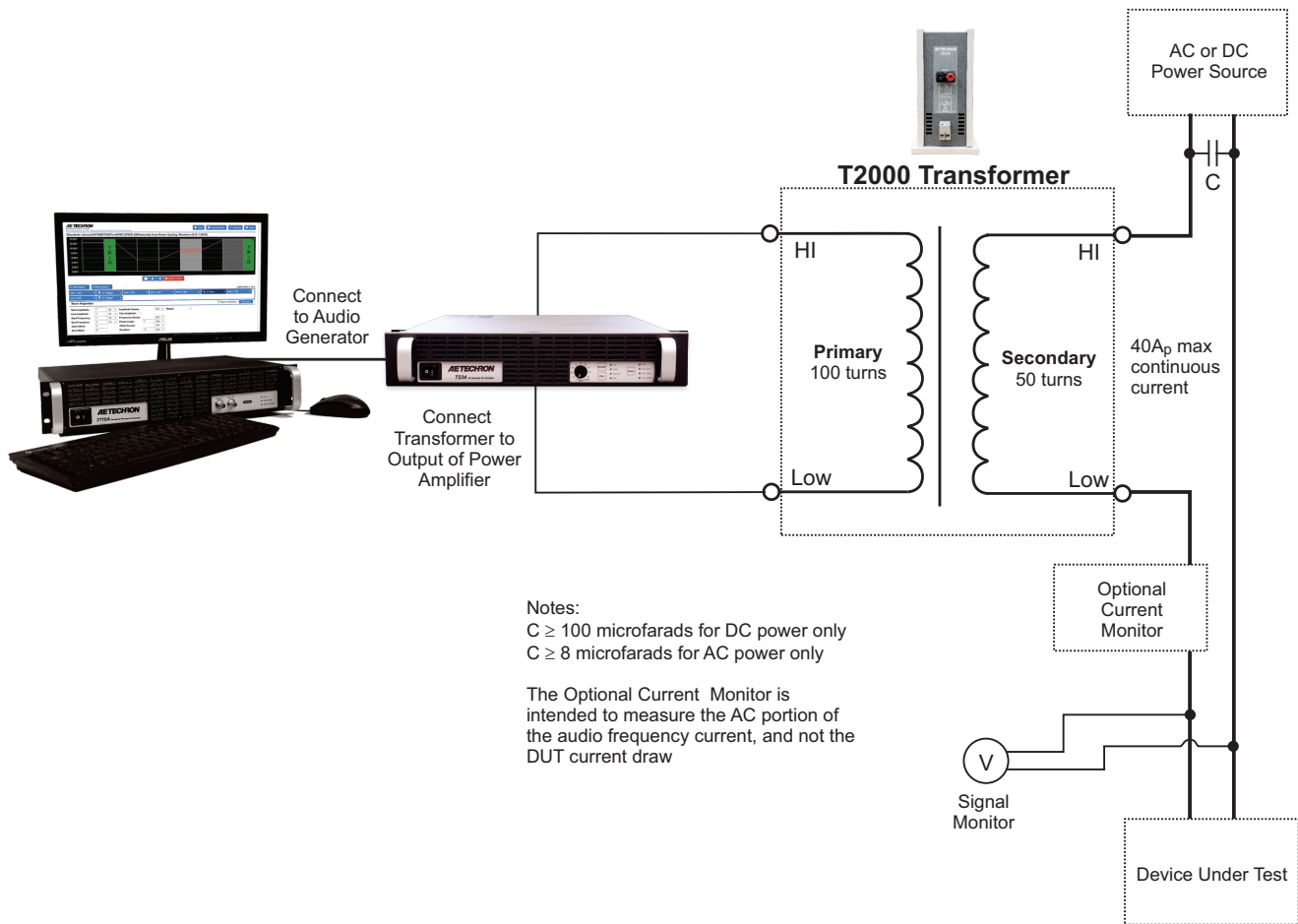

Figure 1 – Sample Application: DO 160 Section 18 Test Setup (for AC and DC power lines, differential mode)

## Specifications

### Performance Specifications

#### Transformer DC Resistance,

##### Primary:

0.076 ohms

##### Secondary:

0.021 ohms

#### Frequency Response:

10 Hz to 250 kHz

#### Audio Power:

200W

#### Dielectric Test:

1500 VDC primary to secondary

#### Secondary Saturation:

40A<sub>P</sub> AC or DC maximum

#### Turns Ratio::

Two-to-one step down

#### Secondary Inductance:

Approximately 0.6 mH (unloaded)

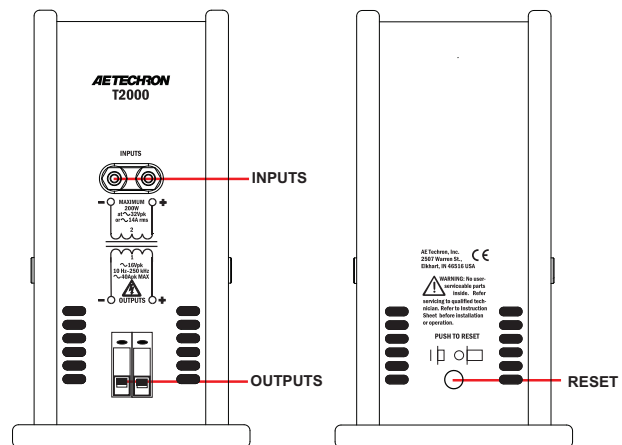

Figure 2 – T2000 Controls and Connectors

#### Protection:

Input power-protected via thermal breaker; secondary winding protected via 35A<sub>RMS</sub> breaker

---

## Controls and Connectors

(see **Figure 2**)

### Input Terminals:

4-way binding posts

### Output Terminals:

Feed-through terminal block connectors (76A); accepts up to AWG 6 wire

### Circuit Breaker:

Secondary winding limited to 35A<sub>RMS</sub> via circuit breaker; push to reset.

## Physical Characteristics

### Case:

Steel interior shell with a durable external shell made from high-density polyethylene for impact resistance.

## Operating Conditions,

**Temperature:** 10°C to 40°C (50°F to 104°F)

**Humidity:** 70% or less, non-condensing

### Recommended Ambient Temperature:

25°C (77°F)

### Cooling:

Natural air convection

### Weight:

17 lbs. (7.7 kg)

### Dimensions (WxDxH):

5.25 in. x 10.375 in. x 9.75 in. (13.3 cm x 26.4 cm x 24.8 cm)

*AE Techron Sales Representative*



## T3700 Transformer for Electric-Field Susceptibility Testing

### For testing to these Specifications:

- DO 160 Section 19
- Boeing D6-16050-5 Section 7.2

### Features

- Up to 3,700  $V_{RMS}$
- Meets or exceeds voltage requirements of DO 160 Section 19 and Boeing D6-16050-5 Section 7.2
- Robust design, withstand tested to 5,000 VDC
- Durable steel and high-density polyethylene case for impact resistance

The AE Techron **T3700 Electric-Field Susceptibility Transformer** was designed to meet or exceed the voltage requirements of DO 160 Section 19 and Boeing D6-16050-5 Section 7.2 testing.

It may also be used as a 1-to-37 step-up transformer for voltages up to 3700  $V_{RMS}$ .

The T3700 transformer is able to generate up to a 3700  $V_{RMS}$  potential. It is withstand tested to 135% of rated output to ensure a long, trouble-free life. The turns ratio provides a 1-to-37 step up to the secondary winding.

The T3700 provides convenient input connectors via touch-proof, four-way binding posts. Standard 0.75-inch spacing of binding posts allows use of standard plugs.

A 1-amp fuse protects the unit against over-current conditions. A rugged, impact-resistant case and robust design protects the transformer from accidental damage.

The T3700's voltage output meets or exceeds the requirements of DO 160 Section 19 and Boeing D6-16050-5 Section 7.2. It is safe for use by experienced staff.

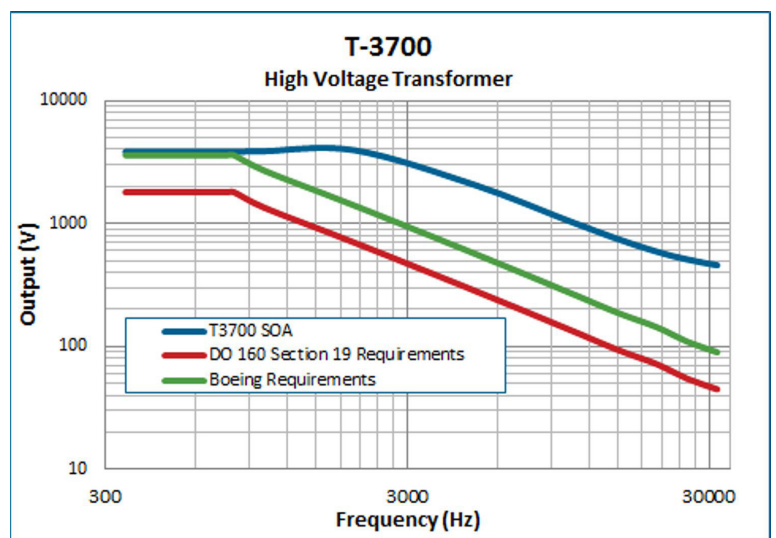

Figure 1 – T3700 Maximum SOA (safe operating area)

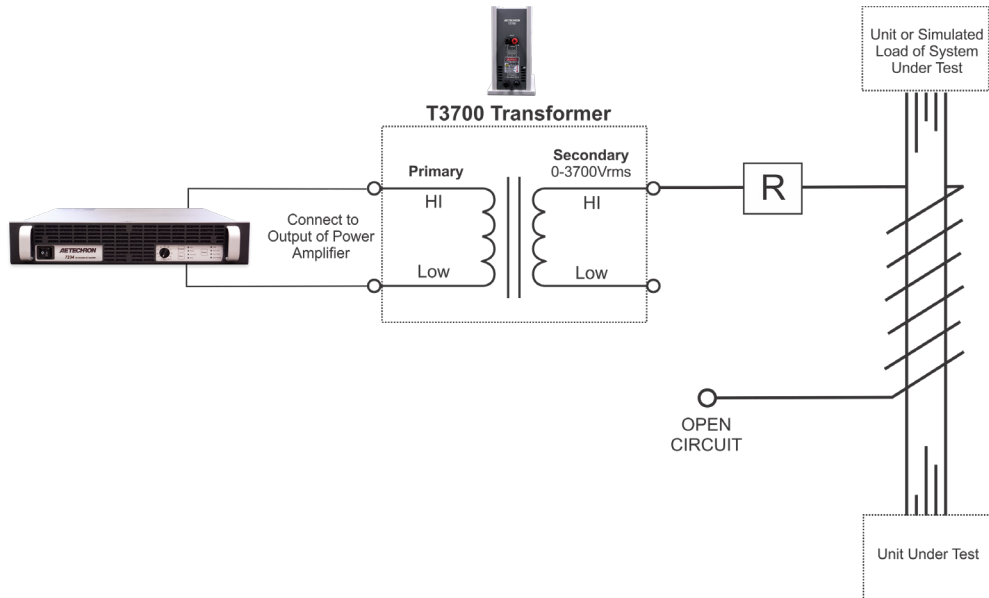

Figure 2 – DO 160 Section 19 Test Load Wiring

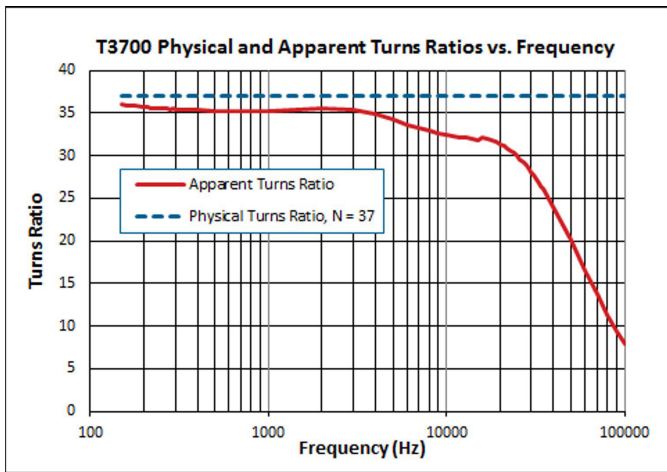

Figure 3 – Physical and Apparent Turns Ratios vs. Frequency

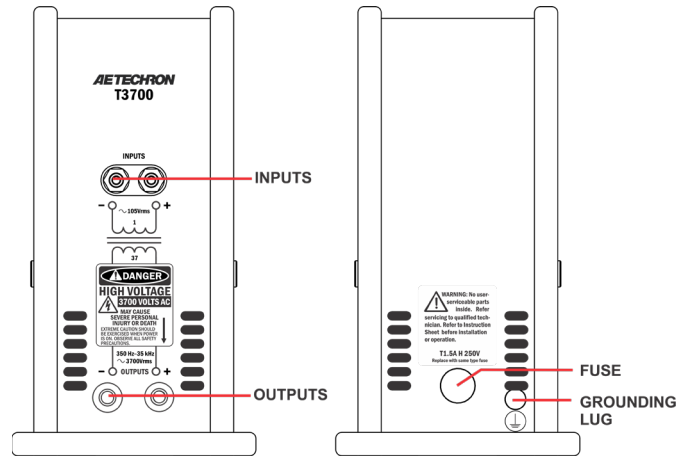

Figure 4 – T3700 Controls and Connectors

## Specifications

### Performance Specifications

#### Primary:

100 V<sub>RMS</sub> maximum or 1 A<sub>RMS</sub>, maximum

#### Secondary:

3700 V<sub>RMS</sub> maximum output

#### Physical Turns Ratio:

1-to-37 step up

#### Dielectric Test:

5 kVDC primary to case

5 kVDC secondary to case

#### Frequency Range:

250 Hz to 35 kHz

#### Protection:

Current-protected input

### Controls and Connectors

(see Figure 4)

#### Input Terminals:

4-way binding posts

#### Output Terminals:

LGH high-voltage connector (+)

Banana jack (-)

#### Over-Current Protection:

Primary input limited via fuse to 1A (T1A H 250V)

#### Grounding Lug:

Screw terminal grounding connector. Connect to earth ground using appropriate wire and connector.

---

## Physical Characteristics

**Case:**

Steel interior shell with a durable external shell made from high-density polyethylene for impact resistance.

**Operating Conditions,**

**Temperature:** 10°C to 40°C (50°F to 104°F)

**Humidity:** 70% or less, non-condensing

**Recommended Ambient Temperature:**

25°C (77°F)

**Cooling:**

Natural air convection

**Weight:**

16 lbs. (7.3 kg)

**Dimensions (WxDxH):**

5.25 in. x 10.375 in. x 9.75 in. (13.3 cm x 26.4 cm x 24.8 cm)

*AE Techron Sales Representative*



## CR 600 Chattering Relay for DO-160 Section 19.3.5 Testing

### Features

- Coil Voltage: 24 VDC
- Coil Current: 84 mA
- Contact Rating: 30A
- Typical Pulse Voltage: >700 Vpp
- Includes oscilloscope connection points for voltage monitoring

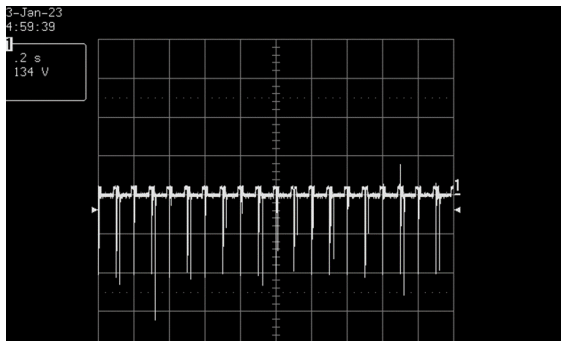

Figure 1 – Example of output from the CR 600 when adjusted to yield a pulse repetition rate of eight to ten pulses per second

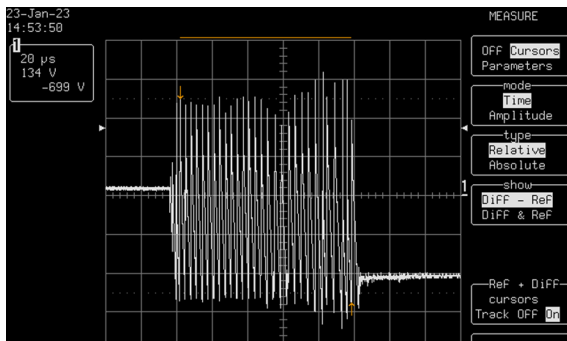

Figure 2 – Example of output from the CR 600 when adjusted for a pulse sequence with an amplitude greater than or equal to 600 Vpp, and a total duration of 50 to 1000 microseconds

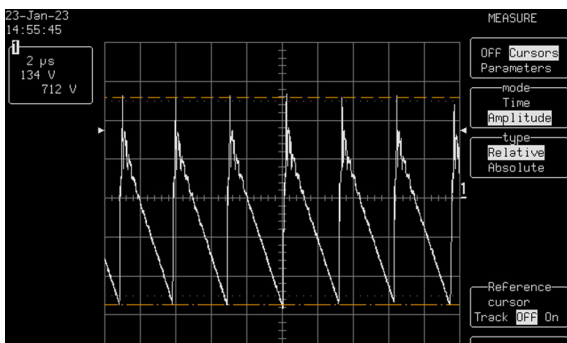

Figure 3 – Example of output from the CR 600 when adjusted for a repetition period of 0.2 to 10 microseconds

The AE Techron **CR 600 Chattering Relay** is a cost-effective, rugged yet elegant solution to the DO 160 Section 19.3.5 “Spikes Induced into Interconnecting Cables” test requirement.

Internally built around a 50A high-current relay with two independent sets of contacts, the CR 600 was engineered for double the life before refurbishment.

The CR 600 uses quick-connect, touch-proof connectors to ensure efficient setup and a safe test environment. It also includes quick-clip test points for oscilloscope monitoring of tests in progress.

When driven from an intermittent voltage source like the AE Techron DSR 100-25 and utilizing test waveform, “Section 19.3.5 CR 600”, the CR 600 output meets the voltage (600V), duration (50 – 1000  $\mu$ s) and repetition-period (0.2 to 10  $\mu$ s) requirements specified by the DO-160 standard.

### For testing to these Specifications:

- DO 160 Section 19.3.5

### Product Specifications

#### Performance

Coil Voltage: 24 VDC

Coil Current: 84 mA

Contact Rating: 30A

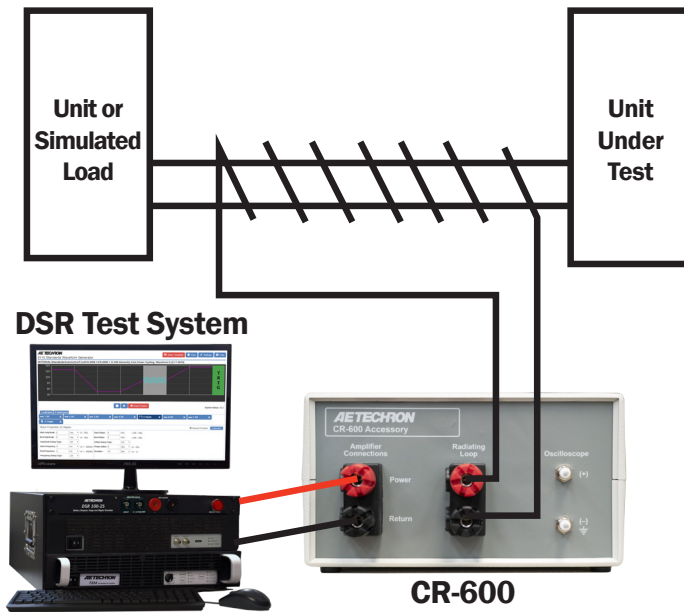

Figure 2 – Sample Application: Test Setup for RTCA DO160 Section 19.3.5 using the CR 600

**Typical Pulse Voltage:** >700 Vpp

### Controls and Connectors

**Amplifier Connections:**

Dual binding posts

**Radiating Loop:**

Dual binding posts

**Oscilloscope:**

Dual turret connectors

### Physical Characteristics

**Case:**

Injection-molded plastic

**Operating Conditions,**

**Temperature:** 10°C to 40°C (50°F to 104°F)

**Humidity:** 70% or less, non-condensing

**Recommended Ambient Temperature:**

25°C (77°F)

**Cooling:**

Natural air convection

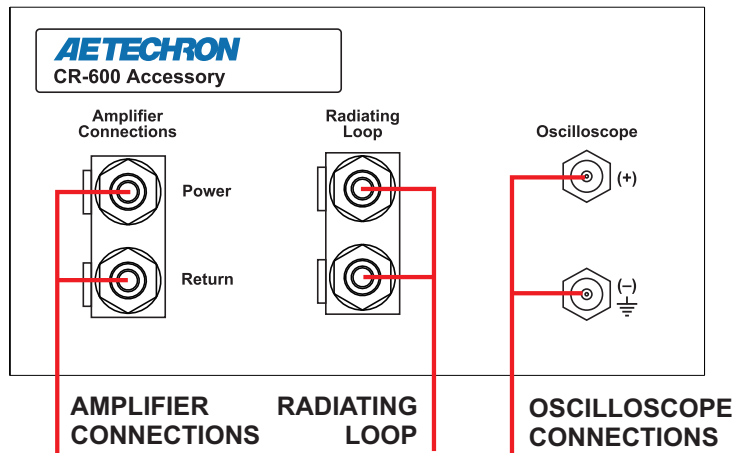

Figure 3 – CR 600 Connectors

**Weight:**

1.5 lbs. (0.68 kg)

**Dimensions (HxWxD):**

3.25 in. x 6.25 in. x 7.25 in. (8.3 cm x 15.9 cm x 18.4 cm)

*AE Techron Sales Representative*